



EDGE User Guide

Version 3.0.a

Last Modified 2021.10.26

Corresponds to EDGE Software Version 3.0



Creating Markets, Creating Opportunities

Page intentionally left blank

TABLE OF CONTENTS

TABLE OF CONTENTS

TABLE OF CONTENTS	3
LIST OF FIGURES	5
LIST OF TABLES	6
CHANGE LOG	9
ACRONYMS	10
INTRODUCTION	12
EDGE CERTIFICATION GUIDANCE.....	14
NAVIGATING THE EDGE APP	24
DESIGN PAGE GUIDANCE	30
GREEN MEASURES OVERVIEW	44
INDIVIDUAL MEASURES IN EDGE	54
ENERGY EFFICIENCY MEASURES	56
EEM01* - WINDOW-TO-WALL RATIO	57
EEM02 - REFLECTIVE ROOF	60
EEM03 - REFLECTIVE EXTERIOR WALLS.....	66
EEM04 - EXTERNAL SHADING DEVICES	69
EEM05* - INSULATION OF ROOF	75
EEM06* - INSULATION OF GROUND/RAISED FLOOR SLAB	79
EEM07 - GREEN ROOF	83
EEM08* - INSULATION OF EXTERIOR WALLS	85
EEM09* - EFFICIENCY OF GLASS	90
EEM10 - AIR INFILTRATION OF ENVELOPE	95
EEM11 - NATURAL VENTILATION	97
EEM12 - CEILING FANS	104
EEM13* - COOLING SYSTEM EFFICIENCY.....	107
EEM14 - VARIABLE SPEED DRIVES.....	114
EEM15 - FRESH AIR PRE-CONDITIONING SYSTEM	117
EEM16* - SPACE HEATING SYSTEM EFFICIENCY	120
EEM17 - ROOM HEATING CONTROLS WITH THERMOSTATIC VALVES.....	124
EEM18 - DOMESTIC HOT WATER (DHW) SYSTEM EFFICIENCY	126
EEM19 - DOMESTIC HOT WATER PREHEATING SYSTEM	131
EEM20 - ECONOMIZERS.....	134
EEM21 - DEMAND CONTROL VENTILATION USING CO ₂ SENSORS.....	137
EEM22 - EFFICIENT LIGHTING FOR INTERNAL AREAS.....	140
EEM23 - EFFICIENT LIGHTING FOR EXTERNAL AREAS	144
EEM24 - LIGHTING CONTROLS	145
EEM25 - SKYLIGHTS.....	150
EEM26 - DEMAND CONTROL VENTILATION FOR PARKING USING CO SENSORS	154

TABLE OF CONTENTS

EEM27* – INSULATION FOR COLD STORAGE ENVELOPE	157
EEM28 – EFFICIENT REFRIGERATION FOR COLD STORAGE	159
EEM29 – EFFICIENT REFRIGERATORS AND CLOTHES WASHING MACHINES	163
EEM30 – SUBMETERS FOR HEATING AND/OR COOLING SYSTEMS.....	166
EEM31 – SMART METERS FOR ENERGY	168
EEM32 – POWER FACTOR CORRECTIONS	171
EEM33 – ONSITE RENEWABLE ENERGY	173
EEM34 – ADDITIONAL ENERGY SAVING MEASURES.....	176
EEM35 – OFFSITE RENEWABLE ENERGY PROCUREMENT	177
EEM36 – CARBON OFFSETS	179
EEM37 – LOW IMPACT REFRIGERANTS	181
WATER EFFICIENCY MEASURES	183
WEM01 – WATER-EFFICIENT SHOWERHEADS	184
WEM02* – WATER-EFFICIENT FAUCETS FOR PRIVATE/ALL BATHROOMS.....	186
WEM03* – WATER-EFFICIENT FAUCETS FOR PUBLIC BATHROOMS.....	188
WEM04* – EFFICIENT WATER CLOSETS FOR PRIVATE/ALL BATHROOMS	189
WEM05* – EFFICIENT WATER CLOSETS FOR PUBLIC BATHROOMS	191
WEM06 – WATER-EFFICIENT BIDET.....	192
WEM07 – WATER-EFFICIENT URINALS	194
WEM08* – WATER-EFFICIENT FAUCETS FOR KITCHEN SINKS	196
WEM09 – WATER-EFFICIENT DISHWASHERS	198
WEM10 – WATER-EFFICIENT PRE-RINSE SPRAY VALVES FOR KITCHEN.....	200
WEM11 – WATER-EFFICIENT WASHING MACHINES	202
WEM12 – SWIMMING POOL COVERS	204
WEM13 – WATER-EFFICIENT LANDSCAPE IRRIGATION SYSTEM	206
WEM14 – RAINWATER HARVESTING SYSTEM	208
WEM15 – WASTE WATER TREATMENT AND RECYCLING SYSTEM	210
WEM16 – CONDENSATE WATER RECOVERY	212
WEM17 – SMART METERS FOR WATER.....	214
WEM18 – ADDITIONAL WATER SAVING MEASURE	216
MATERIALS EFFICIENCY MEASURES	217
MEM01* – BOTTOM FLOOR CONSTRUCTION	219
MEM02* – INTERMEDIATE FLOOR CONSTRUCTION	223
MEM03* – FLOOR FINISH.....	227
MEM04* – ROOF CONSTRUCTION	231
MEM05* – EXTERIOR WALLS	237
MEM06* – INTERIOR WALLS.....	246
MEM07* – WINDOW FRAMES.....	253
MEM08* – WINDOW GLAZING	256
MEM09* – ROOF INSULATION	258
MEM10* – WALL INSULATION.....	261

TABLE OF CONTENTS

MEM11* – FLOOR INSULATION	264
REFERENCES	267
APPENDIX 1. EDGE METHODOLOGY	273
APPENDIX 2. GROUPING LOGIC FOR RESIDENTIAL UNITS (THE 10% RULE)	283
APPENDIX 3. COUNTRY SPECIFIC CONSIDERATIONS	286
APPENDIX 4. RECORD OF POLICY UPDATES IN THE USER GUIDE	290

* Indicates a required measure

LIST OF FIGURES

Figure 1. EDGE Certification Process	17
Figure 2. Screenshot showing the primary layout of the EDGE App	24
Figure 3. Screenshot of the EDGE App showing key features	24
Figure 4. An example of default values and user entries in the EDGE App	25
Figure 5. Most fields in the EDGE App are editable	25
Figure 6. Most measures in the EDGE App are editable.....	26
<i>Figure 7. Users can link projects together with the EDGE project structure.</i>	<i>31</i>
<i>Figure 8. A Residential Project will typically have more than one Subproject.</i>	<i>32</i>
<i>Figure 9. A Commercial project may also have one or more Subprojects.</i>	<i>32</i>
<i>Figure 10. A Project can have a single Subproject if the whole building is modeled in the same EDGE file.</i>	<i>33</i>
Figure 11. Sample Energy chart from the Apartments typology	49
Figure 12. Sample Water Chart from the Apartments typology	51
Figure 13. Sample Materials Chart from the Offices typology.....	53
Figure 14. Screenshot of energy saving measures of one building type (Homes) in the EDGE App	56
Figure 15. Source: Coolroof toolkit	60
Figure 16. Illustration of the dimensions used to calculate the shading factor.....	69
Figure 17. Recommended position of the low-e coating for double-pane glass	92
Figure 18. Auto shut-off control for air-conditioning based on natural ventilation	99

TABLE OF CONTENTS

Figure 19. Schematic of cooling tower and VSDs system	115
Figure 20. Typical Sources of Waste Heat and Recovery Options	122
Figure 21. Components of an air-side economizer system	135
Figure 22. Integrated Water-Side Economizer in a Water-cooled Chilled Water Plant	136
Figure 23. Energy savings due to CO ₂ sensors. Source ²³	138
Figure 24. Daylight zone configuration	146
Figure 25. Daylight zone under roof skylights	151
Figure 26. Daylight zone under a vertical skylight (roof monitor) with a flat top	152
Figure 27. Daylight zone under a vertical skylight (roof monitor) with a sloping top	152
Figure 28. Energy savings due to CO sensors (extrapolated from CO ₂ sensors) Source ²³	155
Figure 29. Home screen to of smart meter with display options to inform home users.....	169
Figure 30. Screenshot of water saving measures in EDGE for Homes	183
Figure 31. Screenshot of Materials saving measures in EDGE for Hospitality	217
Figure 32. The admissible range of areas that can be represented by a single residential unit type	283
Figure 33. SANS alerts for South Africa when project does not meet SANS requirements.. ..	286

LIST OF TABLES

Table 1: The meaning of a "required" (*) measure in EDGE demonstrated with an example	27
Table 2. EDGE Building types.....	30
Table 3: Definitions of select space types under Area Details	39
Table 4: Base Case System Type Selection.....	46
Table 5: Base Case System Descriptions	47
Table 6: Solar reflectance Index (SRI) values for typical roofing materials.....	61
Table 7: Solar reflectivity of typical wall finishes	67
Table 8: Shading factors for horizontal shading devices at different latitudes for each orientation.....	70

TABLE OF CONTENTS

Table 9: Shading factors for vertical shading devices at different latitudes for each orientation	71
Table 10: Shading factors for combined shading devices at different latitudes for each orientation	71
Table 11: Typical shading devices.....	72
Table 12: Shading strategies for different orientations at the design stage.	72
Table 13: Thickness of insulation required to achieve a U-value of 0.45 W/m ² K	76
Table 14. Insulation types and typical conductivity range	77
Table 15. Insulation types and typical conductivity range	81
Table 16: Thickness of insulation required to achieve a U-value of 0.45 W/m ² K	86
Table 17. Insulation types and typical conductivity range	88
Table 18: Approximate SHGC and U-values for different glazing types	93
Table 19: Areas to be Naturally Ventilated, by Building Type.....	97
Table 20: Types of natural ventilation	100
Table 21: Depth of floor to ceiling height ratios for different room configurations	101
Table 22: Minimum area of opening as a proportion of floor area for different heat gain ranges.	102
Table 23: Minimum Required Spaces to be Provided with Ceiling Fans, by Building Type	104
Table 24: Minimum fan size (in meters)/Number of ceiling fans required for different room sizes.	105
Table 25: Types of Ground Source Heat Pumps.	111
Table 26. Examples of current minimum COPs for different types of air conditioning systems.....	112
Table 27: Benefits and limitations of VSD motors for pumps	115
Table 28: Types of Condensing Boiler.....	121
Table 29: Recovery technology options	122
Table 30: Types of High Efficiency Hot Water Boilers.....	128
Table 31: Types of solar water collectors	129
Table 32: Gray Water Heat Recovery Solutions	132
Table 33: Indoor spaces required to have efficient lighting, by Building Type	140

TABLE OF CONTENTS

Table 34: Description of technologies (lamp types).....	142
Table 35: Typical range of efficacies for different lamp types	142
Table 36: Outdoor spaces required to have efficient lighting, by Building Type	144
Table 37: Lighting Control Requirements by Building Type	145
Table 38: Types of controls for lighting and other equipment	147
Table 39: Types of refrigerated cases	160
Table 40: Efficiency measures for Refrigerated cases	161
Table 41: Types of Models for Energy Performance.....	274

CHANGE LOG

CHANGE LOG

V3.0

This is the first version of the User Guide for EDGE 3.0.

This User Guide contains the complete list of efficiency measures available in EDGE for all building types. A separate document called the 'EDGE Materials Reference Guide' provides more detailed information on all construction materials available in EDGE.

The last Appendix will be updated periodically to reflect any new policy changes in EDGE version 3.

To share updates with the EDGE Team, such as local rates for energy and water, please send suggestions along with relevant documentation to edge@ifc.org.

ACRONYMS

AHU	Air Handling Unit
ARI	Air-conditioning and Refrigeration Institute
ASHRAE	American Society of Heating Refrigerating and Air-conditioning Engineers
Btu	British thermal unit
cfm	Cubic feet per minute (ft ³ /min)
COP	Coefficient of Performance
EDGE	Excellence in Design for Greater Efficiencies
EPI	Energy Performance Index (kWh/m ² /year)
GIA	Gross Internal Area
GJ	Giga Joules
HVAC	Heating, Ventilation and Air-conditioning
kW	Kilowatt
kWh	Kilowatt-hour
MJ	Megajoules
ppm	Parts per million
SC	Shading Coefficient
SHGC	Solar Heat Gain Coefficient
sqm	Square Meter
STP	Sewage Treatment Plant
TR	Tonnage of Refrigeration
VLT	Visible Light Transmission
VAV	Variable Air Volume
VFD	Variable Frequency Drive
VSD	Variable Speed Drive
W	Watt

CHANGE LOG

Wh	Watt-hour
WFR	Window-to-Floor Ratio
WWR	Window-to-Wall Ratio

INTRODUCTION

INTRODUCTION

About EDGE (“Excellence in Design for Greater Efficiencies”)

EDGE is a green buildings platform that includes a global green building standard, a software application, and a certification program. The platform is intended for anyone who is interested in the design of a green building, whether an architect, engineer, developer or building owner.

EDGE empowers the discovery of technical solutions at the early design stage to reduce operational expenses and environmental impact. Based on the user’s information inputs and selection of green measures, EDGE reveals projected operational savings and reduced carbon emissions. This overall picture of performance helps to articulate a compelling business case for building green.

The suite of EDGE building types includes Homes, Apartments, Hospitality, Retail, Industrial, Offices, Healthcare, Education buildings, and Mixed-Use Buildings. EDGE can be used to certify buildings at any stage of their life cycle; this includes buildings in concept or design stage, new construction, existing buildings, and renovations.

EDGE is an innovation of IFC, a sister organization of the World Bank and member of the World Bank Group.

A Global Green Standard

To achieve the EDGE standard, a building must demonstrate a 20% reduction in projected operational energy consumption, water use, and embodied energy¹ in materials as compared to typical local practices. EDGE defines a global standard while contextualizing the base case to the building functions and its location.

Only a handful of measures are required for better building performance that result in lower utility costs, extended equipment service life, and less pressure on natural resources.

The EDGE Perspective

Rather than relying on complex simulation software and processes to predict resource use, EDGE has an easy-to-use interface that runs on a powerful building physics engine with region-specific data. Through user inputs, the data can be further refined to create a nuanced set of calculations that have greater accuracy when predicting future building performance. EDGE focuses intently on resource efficiency and climate change mitigation, recognizing that too wide a focus leads to disparate results.

The intent of EDGE is to democratize the green buildings market, which was previously reserved for higher-end buildings standing in relative isolation in primarily industrialized nations. Government regulations in emerging economies rarely require resource-efficient building practices. EDGE is creating a new path for green growth by proving the financial case in a practical, action-oriented way that emphasizes a quantitative approach. This

¹ Embodied energy is the energy required to extract and manufacture the materials required to construct and maintain the building.

INTRODUCTION

approach closes the gap between non-existent or weakly-enforced green building regulations and expensive international standards. It realizes the potential to lower utility costs while reducing GHG emissions.

EDGE Software Version 3 is optimized for the following:

- Browser (the following versions or higher): Firefox 81, Chrome 86, or Safari 13
- Operating System: Windows 7 or higher
- Screen Resolution: Viewed best at 1680 X 1050 pixels
- Fully functional and responsive across devices including mobile phones and tablet PCs

An Innovation of IFC

EDGE is an innovation of IFC, a member of the World Bank Group.

IFC

2121 Pennsylvania Avenue, NW

Washington, DC 20433

edge@ifc.org

www.edgebuildings.com

EDGE CERTIFICATION GUIDANCE

EDGE certification is awarded if the required minimum efficiencies of 20% are achieved in the three EDGE categories -- Energy, Water, and Materials. A simple pass/fail system indicates whether the building project has demonstrated the minimum 20% savings in operational energy, water and embodied energy in materials compared to the base case model. Actual percentage savings for each project can be seen on the EDGE certificate as well as in project case studies on the EDGE website. Beyond EDGE certification, EDGE also offers EDGE Advanced and EDGE Zero Carbon certification. The entire certification process is conducted online through the EDGE software.

EDGE Assessment and Certification Definitions

- A **building** is defined as a conditioned (heated or cooled) or naturally ventilated structure with at least one full time equivalent occupant, and a minimum building area of 200m². For questions about specific projects that do not fall within these limits, reach out to the EDGE team at edge@ifc.org.
- A **single home** is a detached single-family home. There is no minimum area requirement.
- A **single building** is a physically separate structure. If two buildings are connected by a conditioned space, then they can be considered as a single building.
- Area limits for **mixed-use buildings**: If a building has more than one use and the secondary use occupies less than 10% of the floor area up to a maximum of 1,000m², the entire building can be certified under the primary use of the building. If the area of secondary use is more than 10% of the floor area or more than 1,000m², then that portion must be certified separately. For example, if a 10,000m² residential building has a retail portion of 1,200m² located within the ground floor, the building areas must be certified separately under the Homes and Retail typologies.
- **Multiple buildings**: When one project (such as a housing development) with a single owner consists of several buildings, buildings of less than 10% of the floor area of the project up to a maximum of 1,000m² with the same use may be clustered together as a single building. Buildings larger than 10% of the project floor area or more than 1,000m² must be considered as separate buildings. In **residential projects**, however, each individual unit would receive an EDGE certificate, not the overall building. When multiple types of units are present, each unit type in the project is assessed separately.
- **Project**: A Project is defined as the whole building or development submitted for EDGE certification with the same certifier and owner. For example, a Project may be a residential building with two towers, a mixed-use building with offices and retail space, or multiple buildings with the same specifications in a city or country. The information in the Project section in EDGE is the top-level information that applies to the whole project.
- **Subproject**: A Subproject is each portion of the Project modeled individually in EDGE. The information contained in the Subproject section applies only to the portion being modeled in that

EDGE CERTIFICATION GUIDANCE

file. For example, a Subproject may be Unit Type 1 in a residential building, the retail space in a mixed-use tower, or an individual location for a chain of stores.

Project Roles

Project Team/EDGE Experts

In the EDGE certification system, a project owner is the designated owner or owner's representative responsible for the entire project including providing project documentation, access to the site, and the payment of audit and certification fees. An EDGE Expert is an individual *certified* in the use of EDGE software and certification process; they may be part of the owner's organization or an independent service provider.

The project owner designates a project team (which may include an EDGE Expert) whose role is to demonstrate that the project complies with the EDGE standard. The project team achieves this by documenting that the overall project and the selected individual measures meet the specifications and minimum performance required by EDGE.

Four distinct user roles for an EDGE project team are available in the EDGE software to represent the typical certification software responsibilities.

1. A Project Owner can assign or remove any user role and create/edit/delete projects in the EDGE software.
2. A Project Admin is the EDGE Expert or a trained EDGE user who manages the certification flow of the project on behalf of the owner.
3. A Project Editor is typically someone from the design team who can edit the project details and documentation.
4. A Project Viewer can track the project progress without the ability to edit.

EDGE Certifiers

EDGE Certifiers are licensed by IFC to operate in designated countries. Their role is to oversee EDGE Auditors and issue the EDGE certificates. Information on contacting local certifiers is available on the 'Certify' page at www.edgebuildings.com. The project owner is responsible for paying the certification fees to the EDGE Certifier.

EDGE Auditors

EDGE Auditors are EDGE Experts who have been further *accredited* to conduct project audits for EDGE certification. The role of the EDGE Auditor is to verify that the design/construction team has interpreted the EDGE requirements correctly and that all compliance requirements have been fulfilled. Depending on the country and the certification provider, an EDGE Auditor may be part of the EDGE Certifier's team or hired independently. In either case, the project owner is responsible for the EDGE Auditor fees.

The EDGE Auditor reviews the supporting evidence provided by the project team to ensure that it matches the data used in the assessment and performs on-site audits. Auditors must verify 100% of the floor area for a unique design for any building type. In the case of repetition in design, an auditor must verify the following at a minimum:

- Homes, Apartments (square root of the number of units) +1, for each type

EDGE CERTIFICATION GUIDANCE

- Hotels, Resorts, Serviced Apartments (square root of the number of rooms) +1, for each type
- Healthcare (square root of the number of rooms) +1, for each type
- Retail, Industry, Office, Education 40% of similar areas for a project
- Mixed Use Each use type to follow respective rules from above
- Multiple buildings of same type: (square root of the number of buildings) +1, for each type

EDGE CERTIFICATION GUIDANCE

EDGE Certification Process

The certification process involves auditing of the project documentation submitted by the project team and a site audit, followed by the award of the certificate. Requirements for EDGE compliance, at both the design and post-construction phases, are specified for each measure in this guide, and include such deliverables as design drawings, manufacturers' data sheets, calculations, proof of delivery and photographs. A design review is required for preliminary certification, and a site audit is required for the final EDGE certification, with both conducted by an accredited EDGE Auditor. Certification is awarded by a licensed EDGE certification provider. EDGE certification makes a statement of corporate excellence and environmental responsibility.

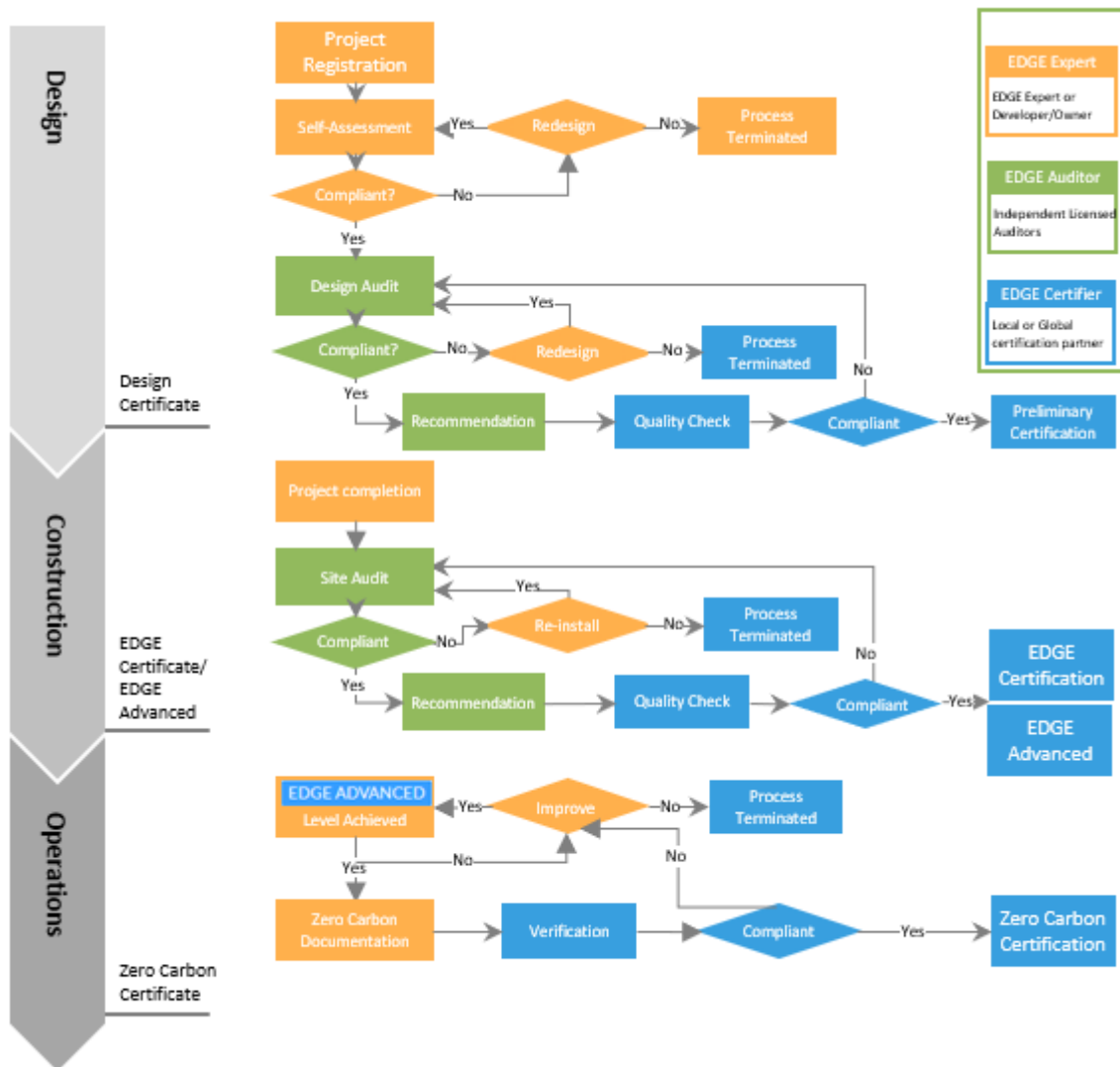

Figure 1. EDGE Certification Process

To begin the certification process, the project owner/EDGE Expert may request a quote from the local certification provider via the Certify page on the EDGE buildings website; they may also 'Express Interest' via the EDGE software to request a quote from the certifier or local auditor(s). Or a project may choose to directly 'Register' in the EDGE App.

EDGE CERTIFICATION GUIDANCE

Documentation Requirements

Project-level documentation is uploaded to the EDGE App. The documentation required for individual measures is included in the Compliance Guidance of each measure. In general terms the following documents are required to demonstrate compliance:

- A brief explanation of the relevant system or product specified/installed.
- Calculations that have been used to assess and demonstrate compliance.
- Manufacturer's data sheets, with the information required to demonstrate compliance highlighted.
- Proof that the specified system or product has been installed.

EDGE Advanced Certification

'EDGE Advanced' status indicates that an EDGE project has achieved 40% or greater savings in Energy, beyond the minimum EDGE certification requirements.

EDGE Advanced certification is a one-time award that does not need to be renewed. Recognition is issued automatically at the time of the awarding of a preliminary EDGE certificate and/or final EDGE certification and indicated on the EDGE certificate for such a project; it does not require additional documentation or fees.

EDGE Zero Carbon Certification

EDGE Zero Carbon certification is awarded to projects that demonstrate zero carbon emissions in operations; it offers project teams the opportunity to certify their projects as carbon neutral. A minimum of 20 percent savings in water and embodied energy are required, with 40 percent energy savings on-site (EDGE Advanced status), and 100 percent energy emissions neutralized either through renewables or carbon offsets.

Eligibility Requirements

There are three requirements for projects to be eligible for EDGE Zero Carbon certification:

1. The building type must be among those that are included in the EDGE App.
2. A building must have been in operation for at least one year at 75 percent of normal occupancy.
3. A building must be certified as EDGE Advanced:
 - For projects previously certified with EDGE, this can be shown with the achievement of EDGE Advanced certification.
 - For projects not previously certified with EDGE, EDGE Advanced certification must first be achieved before EDGE Zero Carbon certification can be pursued.

Documentation Requirements

In obtaining EDGE Zero Carbon certification for a project for the first time, the following information is required:

- A. Proof of 40 percent energy savings from the EDGE baseline: Download, save and provide a PDF of the EDGE certificate for the project from your dashboard in the EDGE App that demonstrates EDGE Advanced status. This is a one-time assessment of the asset that will not need to be provided at the time of recertification unless the building undergoes substantial changes such as a significant addition (more than 10 percent of the Gross Internal Area, or GIA) or a major renovation.
- B. Intended year of certification: The start and end dates for the year for which the project is applying as an EDGE Zero Carbon project.

EDGE CERTIFICATION GUIDANCE

- C. Declaration of occupancy: A signed declaration by the project owner or their authorized representative that the project has been occupied at 75 percent of expected occupancy for the intended year of certification.
- D. Project area: Building plans showing the GIA including airconditioned and unconditioned spaces of the building, and the total GIA for input into the calculator. (Note the description of Total Project Area under the Design Guidance section.) If the project has achieved EDGE-certified status, then the project's PDF report showing the GIA and the project file number will be sufficient for verification.
- E. Energy bills and meter readings: bills for the intended year of certification for every source of energy used in the building.

The categories that must be tracked are:

- Fossil fuels used on site, e.g., diesel, natural gas, liquified petroleum gas (LPG)
- On-site electricity produced, e.g., solar, wind, small hydro
- Off-site electricity purchased, e.g., from conventional grid, off-site solar, wind

The bills must show:

- Quantity of energy purchased
- Type of energy source

Energy bills must cover a period of one year starting from the intended start date. For electricity produced on site, documentation may include readings from the renewable system meter, for example, the inverter in a solar system. If the system does not include a meter, specifications of the system with estimated energy production may be used.

- F. Purchased carbon offsets: If applying carbon offsets, they must be purchased from a source that abides by one of the following standards:
 - Climate SEED
 - Community Climate Biodiversity Standard (CCBA)
 - Gold Standard
 - ISO 14064-2
 - UNFCCC Clean Development Mechanism (CDM)
 - Verified Carbon Standard (VCS)

For compliance purposes, the client must obtain a certificate from the carbon offset provider that the offset has been "retired."

Documentation Submission

All energy use information must be input into the EDGE Carbon Calculator, which will be incorporated into the EDGE App. In the interim, it is available as an Excel-based calculator that can be obtained by emailing edge@ifc.org.

EDGE CERTIFICATION GUIDANCE

Once the EDGE Carbon Calculator has been launched online, supporting documentation must be uploaded into the EDGE App. In the interim, the completed calculator and supporting documentation must be submitted via email to the respective certifier.

Certification Expiration

The EDGE Zero Carbon certificate will prominently display the year of awarding and expiration according to the following:

- For a project that meets the EDGE Zero Carbon criteria fully on-site, including generation of on-site renewable electricity, the certificate will expire after four years.
- For a project that meets the EDGE Zero Carbon criteria by purchasing off-site renewable electricity or carbon offsets, the certificate will expire after two years.

Recertification

A project that has been previously certified as EDGE Zero Carbon can recertify to maintain its EDGE Zero Carbon status.

- A. Required energy performance:
 - If the building has not changed substantially since the last EDGE Zero Carbon certification – more than 10 percent change in area, or a major renovation – the project owner or their designated representative must provide a signed statement to that effect.
 - If the building has changed substantially as defined above, the project team must show that the energy savings of the building are 40 percent in the EDGE App. Note that the EDGE standard baseline is revised every few years as construction standards change.
 - If the GIA has changed, it must be indicated.
- B. Annual records of performance: The project must submit annual records of information like that submitted for the original EDGE Zero Carbon certification (see A to F under 'Documentation Requirements'). For prior years, provide:
 - Start date (these must be contiguous with the original years of EDGE Zero Carbon certification)
 - Energy bills and meter readings for energy purchased and produced
 - Carbon offset certificates

EDGE CERTIFICATION GUIDANCE

Existing Building Projects

Existing buildings may apply for EDGE certification. The same standards apply to existing buildings as for new construction. Materials in existing buildings that are being retained in the building or re-used and are older than five years may be claimed as “re-used.” (This applies to re-use of materials older than five years in new construction as well). To claim a building as existing and/or to claim re-use of materials, the project team must provide documentation from the formal local source that shows the date when the building was constructed or last modified. For example, the formal source in a location may be a building department and the documents may be drawings stamped by the building department. Pictures of the existing building and materials should also be provided as evidence. Guidance on inputs for Existing Buildings in specific fields in the EDGE App is provided in the description of the respective fields. This guidance may be viewed by conducting a text search for the word ‘existing’ in this User Guide.

Core and Shell Projects

Core and Shell projects are projects where the owner is responsible for the building exterior (“shell”) and the core facilities (“core”), but the interior areas are constructed by the tenants (“fit out”). For Core and Shell projects, a measure for which the tenants are responsible can also be claimed in EDGE. Measures for which this is allowed are lighting, ceiling fans, faucets, and flooring finish. This is allowed only if a “tenant fit-out guide” is included in the lease agreement and signed between the tenants and owners. This tenant fit-out guide must define the requirements to be fulfilled by the tenants for the measure and be included in the EDGE submission. If all tenants have not signed a lease at the time of EDGE certification, the building owner must show EDGE compliance by providing the template of the lease agreement accompanied by a signed letter stating that the tenant fit-out guide in the template lease agreement will be included in all tenant lease agreements signed for the building. Measures not listed here cannot be claimed unless installed at the time of final site audit.

This type of agreement is typically applied to spaces for rent. However, the same principle can be applied to projects for sale in certain conditions. For example, when there is a local requirement for the developer to provide a warranty to the new owners along with a User Manual, the developer can specify the efficiency requirements of electric fixtures and appliances in the User Manual as a condition for maintaining the warranty.

Partial Building Projects

A part of a building may apply for EDGE certification. For example, a store in a mall or an office in an office building can apply for EDGE certification. If that space is served by a central HVAC system, the EDGE application can document the specifications of the whole building HVAC systems. If the space is served by a stand-alone system, only that system must be documented. For the envelope, the wall lengths, materials, and WWR ratio should represent the actual space applying for certification. Only those exterior facades must be included that are directly in contact with/enclosing the part of the building applying for the EDGE certification. For example, if there is no exterior façade on the east side because the applicant part of the building is attached to the rest of the building on that side, then, the east façade length must be marked as 0.01 m. The same logic applies all the way around. It is possible to have a portion of a building with no exterior walls apply for EDGE, in which case all exterior facades will be marked as 0.01. This will ensure that the heat transfer and therefore, energy performance of the applicant building portion is calculated correctly.

EDGE CERTIFICATION GUIDANCE

Social Housing Projects

Social housing projects are at times provided without finished floors or bathrooms fittings in second bathrooms. For such projects, EDGE makes the following exceptions: (1) Unfinished floor areas can use the EDGE default flooring (ceramic tile), and (2) Bathrooms without fixtures can be ignored for Water measures. However, the bathrooms that do have fittings must have low-flow fixtures to claim the corresponding EDGE measures, as is normally the case. In addition, EDGE encourages developers to provide literature (such as product brochures) on low-flow fittings to prospective apartment buyers through the sales office.

Data Centers

EDGE now offers project teams the opportunity to certify data centers as green. This certification is in the pilot phase. Any data center globally, new or existing, is eligible to apply. There are two requirements for data centers to be eligible for EDGE certification:

1. The datacenter must achieve a minimum of 20 percent savings in Water and Embodied Energy in Materials as per the EDGE standard.
2. The Power Usage Effectiveness (PUE) of the data center must be at least 20% better than the baseline PUE, where

$$PUE = \frac{\text{Total Energy entering the data center measured at its boundary}}{\text{Energy used by the IT equipment inside the datacenter}}$$

EDGE utilizes the PUE (power usage effectiveness) as the energy baseline for data centers. PUE is a metric defined by the Green Grid Association that describes how efficiently a data center uses energy. It is a ratio of the total amount of energy used by a facility to the energy delivered to IT devices.

The baseline PUE is subject to change in the future after the pilot phase of 2020-2021 ends.

Climate Type	Baseline PUE	Target PUE for EDGE Certified (20% improvement)	Target PUE for EDGE Advanced (40% improvement)
Hot & Humid Climate (ASHRAE Climate Zones 1A, 2A, 3A)	1.95	1.56	1.17
Other Climates	1.81	1.45	1.09

Data centers with 20% improvement in PUE will achieve EDGE Certified status and data centers with 40% improvement in PUE will achieve EDGE Advanced status. For more information on how to model data centers in EDGE, project teams can reach out to their respective certifier or email edge@ifc.org.

EDGE CERTIFICATION GUIDANCE

Special Ruling Request (SRR)

A Special Ruling Request (SRR) is a mechanism for project teams to request a special ruling on the eligibility of a method or measure that has not been included in the EDGE App, to determine compliance with EDGE. This is applicable for situations where project teams may want to (1) use an alternative method to comply with the intent of an EDGE Measure, or (2) use innovative strategies not included in the available EDGE Measures to reduce resource consumption in Energy, Water or Materials. For example, an SRR would be required for using an alternate tool outside EDGE to calculate the Average Annual Shading Factor (AASF) or to calculate the savings from a cooling system type that is not available in EDGE.

The SRR form formally documents for audit purposes that a project team has received special permission from IFC's EDGE team to use an out-of-the-norm procedure for claiming measure savings in the EDGE App. Actual compliance with the intent of the measure will still be subject to an audit.

Note that the SRR is a means of formal documentation for audit purposes only. In general, the EDGE User Guides and the Frequently Asked Questions available on the EDGE website serve as a starting point for questions related to the EDGE certification of projects. Further questions about EDGE project measures and certification can be directed to the respective EDGE Certification Provider selected for the project. In addition, the IFC EDGE team is available to help at edge@ifc.org.

If a project team has gone through the steps above and still needs documentation of approval for an atypical approach to its project, it can request a Special Ruling Request form from the certifier.

An SRR is project specific. When the content is universally applicable, it will be added to the User Guide and not require an SRR for compliance anymore.

NAVIGATING THE EDGE APP

NAVIGATING THE EDGE APP

The EDGE App is designed with a simple, user-friendly interface. This section highlights a few key features.

The EDGE App loads in the Homes typology by default. A user can select a different typology from the side bar on the left as shown in Figure 2, or from the drop down menu in the first panel. From the top right options, a user can view their user dashboard, change the version and language, and sign in.

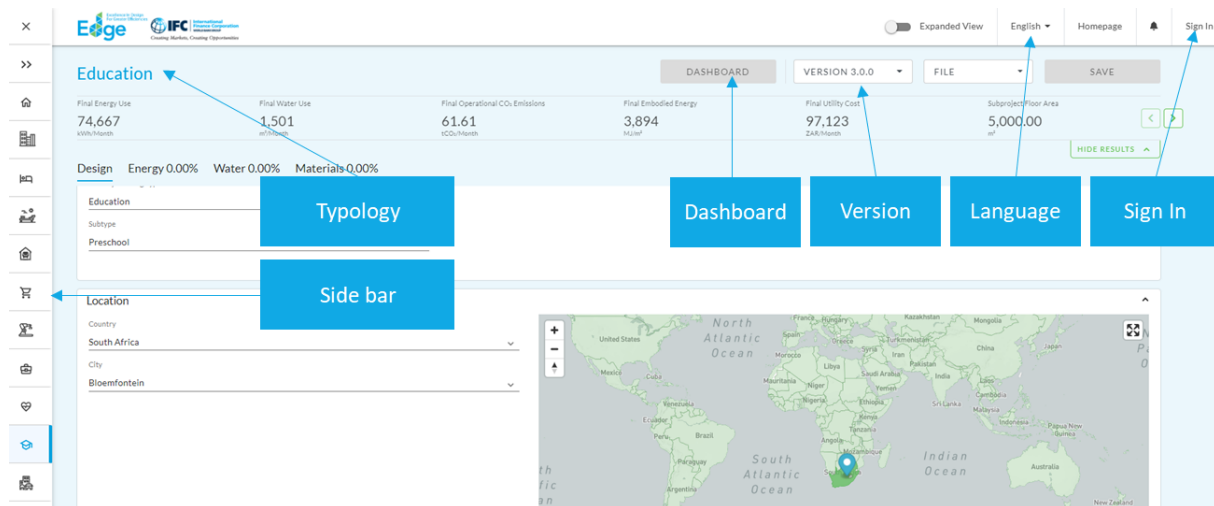

Figure 2. Screenshot showing the primary layout of the EDGE App

Figure 3 shows the main tabs — Design, Energy, Water and Materials. Above the tabs is the Results bar. Some panels on the Design tab, and all Measures, have an Options menu. The Options menu can provide several functions depending on the panel, such as Detailed Inputs, Calculators, or Document Upload.

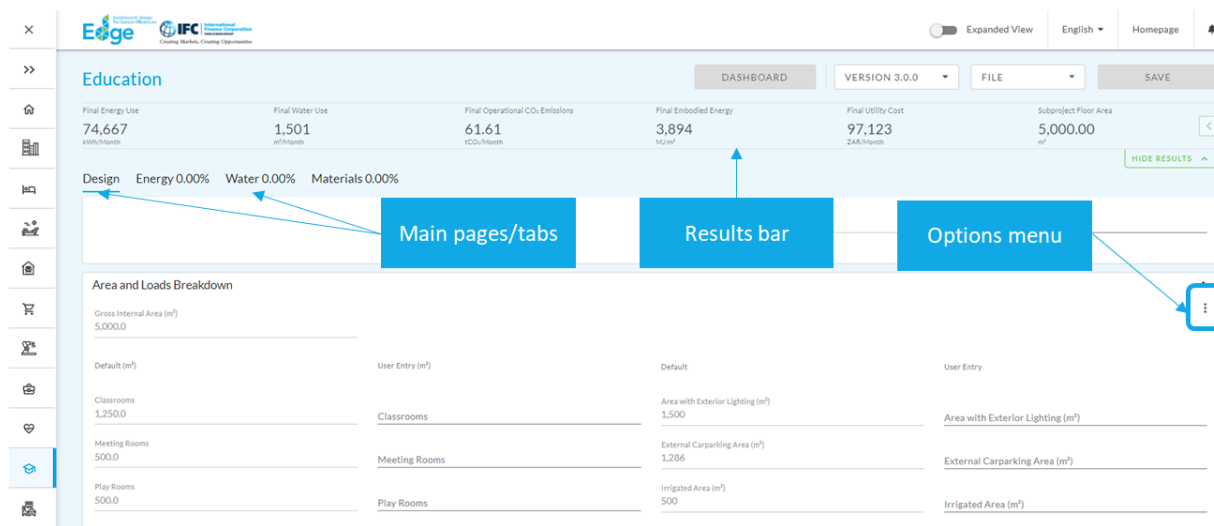

Figure 3. Screenshot of the EDGE App showing key features – the Main Pages or Tabs, Results Bar, and the Options Menu

NAVIGATING THE EDGE APP

Default values and user entries

The EDGE App is designed with default input values for all fields, so that users can model the buildings with minimal inputs.

However, users must note that the EDGE App *will* use the default values unless a user overwrites them. Therefore, attention must be paid to the default values, especially during the certification process, to confirm that the assumptions reflect the actual building.

Fuel Usage

The image shows two side-by-side screenshots of the 'Fuel Usage' section in the EDGE App. The left screenshot shows default values, and the right screenshot shows user entries. Blue boxes and arrows highlight the differences.

Field	Default Value	User Entry
Hot Water Electricity	Electricity	None
Space Heating Electricity	Electricity	Natural Gas
Generator	Diesel	Diesel
% of Electricity Generation Using Diesel	1.00%	0

Annotations:

- Default values:** A blue box labeled 'Default values' with an arrow pointing to the 'Default' column. A text box next to it says 'The default values get crossed out when a user input is provided'.
- User Entries:** A blue box labeled 'User Entries' with an arrow pointing to the 'User Entry' column. A text box next to it says 'User inputs are required when the default does not match the actual building'.

Figure 4. An example of default values and user entries in the EDGE App

Tip: Underlined field names in EDGE are editable.

Project Name*

Clicking on the field name displays the input field.

Project Name*
|

Figure 5. Most fields in the EDGE App are editable

NAVIGATING THE EDGE APP

Similarly, most efficiency measures are editable.

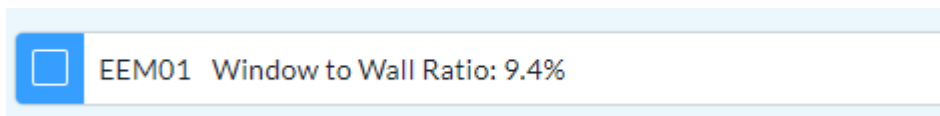

Selecting a measure displays the possible inputs. The value associated with a measure gets overwritten by the user input. For example, in the measure EEM01 in Figure 6, a user can overwrite the value 9.4% with the actual value in the project.

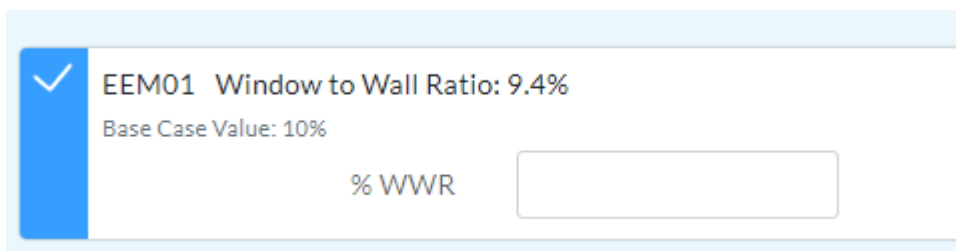

Figure 6. Most measures in the EDGE App are editable

NAVIGATING THE EDGE APP

Required Measures

In EDGE, an asterisk (*) next to a measure indicates that the project team is “required” to enter the actual specifications of the measure in EDGE, if that measure is present in the project.

The indication of a “required” measure in EDGE does not mean that EDGE requires that the measure must be implemented in the project, or that the improved case must meet or exceed the baseline case to comply with EDGE requirements.

For example, if a residential project has air-conditioners, the measure must be selected, and the actual efficiency specifications of the air-conditioners must be entered into the user input fields for the measure.

- If the measure is not present in the project, then the requirement does not apply. For example, if a project does not have air-conditioning, the respective measure can be left blank.
- If the performance of the installed components varies across the project for any reason, then a weighted average of the performance metric must be used. For example, if the COP varies from one space to another, a weighted-average COP must be used for the user input.

The examples in Table 1 explain how to address the measures in EDGE that are required and marked with an asterisk (*), versus those that are not.

Table 1: The meaning of a “required” (*) measure in EDGE demonstrated with an example

Required Measure	How to address in software	How to address at audit
Case 1: Air-conditioning is present in the building		
EEM13* *(asterisk) indicates that the input is Required	<ul style="list-style-type: none"> ✓ Select the matching air-conditioning measure ✓ Enter the actual system efficiency (e.g., COP) in the user input fields for the measure. <p><u>Note:</u> This applies regardless of whether inputting the actual efficiency value generates positive or negative savings.</p>	Auditor must ensure that the measure has been selected and the actual efficiency value as per design or construction has been entered in the EDGE App.
Case 2: Air-conditioning is not present; the building will be naturally ventilated		
EEM13*	<ul style="list-style-type: none"> ✓ In the Design tab, indicate that no air-conditioning is present ✗ In the Energy tab, the air-conditioning measure can be left blank; the asterisk (*) does not apply 	Confirm that air-conditioning, or the fittings to install air-conditioning later, are not present in the project.

Results Bar

The Results Bar in the EDGE App is a summary of the Key Performance Indicators (KPIs) calculated by EDGE. To calculate performance against these indicators, EDGE makes assumptions on how the building will be used by the occupants. Since the actual usage patterns may differ depending on occupant consumption, the water and energy usage and subsequent costs may vary from EDGE predictions. The KPIs include:

- Final Energy Use – the energy consumption (in kWh/month) for the project is calculated automatically by EDGE, based on the data entered in the Design section and any reduction achieved through the selection of efficiency measures.
- Final Water Use – the water consumption (in m³/month) for the project is calculated automatically by EDGE, based on the data entered in the Design section and any reduction achieved through the selection of water efficiency measures.
- Final Operational CO₂ Emissions – EDGE automatically calculates the CO₂ emissions (in tCO₂/month) based on the final energy use multiplied by the CO₂ emission factor for the generation of grid electricity and other fuels in the project. The default value for the selected country's CO₂ emissions is shown in the Design section but can be overwritten if evidence can be provided to support it. The evidence must be from a reliable source such as a peer-reviewed publication from an international organization or a specialized government-approved study.
- Final Embodied Energy – EDGE automatically calculates the embodied energy (in MJ/m²) from the building dimensions and the materials selected in the Materials section.
- Final Utility Cost – EDGE projects the monthly cost (in USD/month or local currency per month) for energy and water use.
- Subproject Floor Area – EDGE displays the calculated GIA for the Subproject multiplied by the Subproject Multiplier.
- Energy Savings
- Water Savings
- Operational CO₂ Savings
- Embodied Energy Savings
- Utility Cost Savings – EDGE projects the annual savings (in USD and local currency in specific countries) in utility bills.
- Base Case EPI (Energy Performance Index) – energy use per unit area
- Improved Case EPI (Energy Performance Index) – energy use per unit area
- Total Building Construction

NAVIGATING THE EDGE APP

- Incremental Cost – Additional cost of implementing the selected efficiency measures (in USD or local currency in specific countries). Certain building measures may contribute to a lower overall cost compared to the baseline. Therefore, negative incremental costs are possible. EDGE cost data is based on average global data and is continuously being refined. It is only meant as a guidance tool for comparison between measures. If specific local data is available, the use of it in a more specific financial model is encouraged for making financial decisions.
- Increase in Cost (%)
- Payback in Years – Number of years to repay the incremental cost compared to the cost savings of utilities. The method used is simple payback based on the capital cost of the measure.
- Number of People Impacted
- Base Case – Refrigerant Global Warming Potential
- Improved Case – Refrigerant Global Warming Potential
- Detailed Results for Typologies – Only applicable to Residential typology. This gets activated when multiple typologies are present.

Saving a Project

Users can save their projects within the online EDGE software platform.

- A user account is required to save a project file, and a user must be logged in to save the project.
- Fields marked with an asterisk* on the Design tab are also required to save the project file.

EDGE can be accessed via handheld devices such as iPhones, Androids and tablets. Project teams should exercise caution when accessing saved projects via handheld devices as EDGE automatically saves changes to projects every three minutes; this time limit does not apply to Certifiers.

If a user is not active on EDGE for two hours, the system will log the user out. This duration of time for which their session stays active while they are away from their computer can be changed by the user in their profile settings.

To create multiple versions of a project with different combinations of measures, it is best to retain your inputs by downloading the data into separate PDFs and saving the documents on your computer (File > Download PDF). In this way, you maintain one project file for your building within EDGE.

DESIGN PAGE GUIDANCE

DESIGN PAGE GUIDANCE

This is the starting point to build an EDGE model. The EDGE software opens in the Homes building type by default. Select the appropriate building type for your model from the dropdown menu.

Building Type

EDGE includes the Primary Building Types, and associated Subtypes shown in Table 2. For a building type that is not on the list, select the closest match from the available types or reach out to edge@ifc.org for guidance.

Table 2. EDGE Building types

Primary Building Type	Subtype(s)
Homes – Single houses and townhomes	Low ² , Middle, and High Income
Apartments – Residential units with shared walls	Low, Middle, and High Income
Hotel	1-Star to 5-star Hotels
Resort	1-Star to 5-Star Resorts
Serviced Apartments	Serviced Apartments
Retail	Department Store, Shopping Mall, Supermarket, Small Food Retail, Non-food Big Box Retail
Industrial	Light Industry, and Warehouse
Office	Office
Healthcare	Nursing Homes, Private Hospital, Public Hospital, Multi-specialty Hospital, Clinics, Diagnostic Center, Teaching Hospital, Eye Hospital, Dental Hospital
Education	Preschool, School, University, Sports Facilities, Other Educational Facilities
Mixed Use	Self-defined Building

² Subsidized/Gap in South Africa

DESIGN PAGE GUIDANCE

Location

- Country – The country in which the project is located. EDGE uses the list of countries from [the World Bank](#)³. If the country of the project location is not in the EDGE drop-down list, select a country and city that is most similar in climate from the available options.
- City – The city in which the project is located. If the project city is not included in the EDGE drop-down list, select the city that is closest in terms of climate. If necessary, overwrite the defaults under Design Page > Climate Data.

Project and Subproject

The Project and Subproject structure on the EDGE App allows users to link related project files and avoid repetitious processes. The purpose of the PROJECT and SUBPROJECT structure in EDGE is to:

- Improve management of files within a single project
- Improve estimation of certification costs
- Streamline registration of files (subprojects) related to a project
- Streamline input of information to each subproject file
- Improve calculation of total project area
- Improve reporting of total project savings

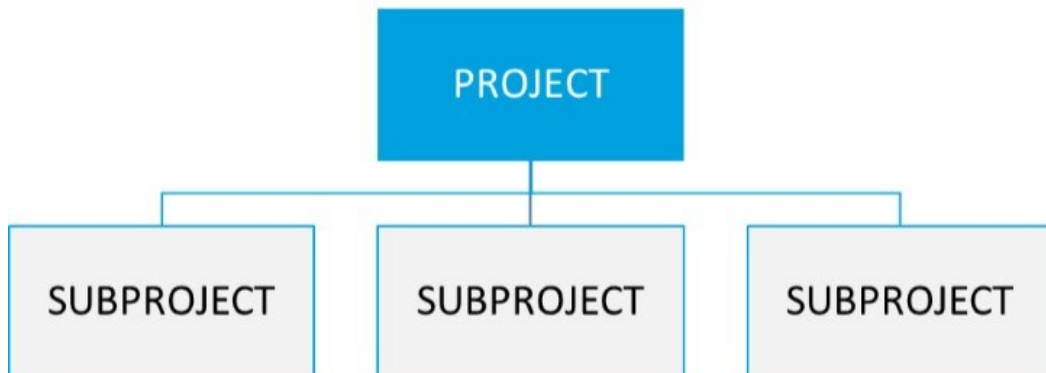

▪ *Figure 7. Users can link projects together with the EDGE project structure.*

Project

A Project is defined as the whole building or development submitted for EDGE certification with the same certifier and owner. For example, a Project may be a residential building with two towers, a mixed-use building with offices and retail space, or multiple buildings with the same specifications in a city or country. The information in the Project section in EDGE is the top-level information that applies to the whole project.

³ <https://data.worldbank.org/country>

DESIGN PAGE GUIDANCE

Subproject

A Subproject is each portion of the Project modeled individually in EDGE. The information contained in the Subproject section applies only to the portion being modeled in that file. For example, a Subproject may be Unit Type 1 in a residential building, the retail space in a mixed-use tower, or an individual location for a chain of stores.

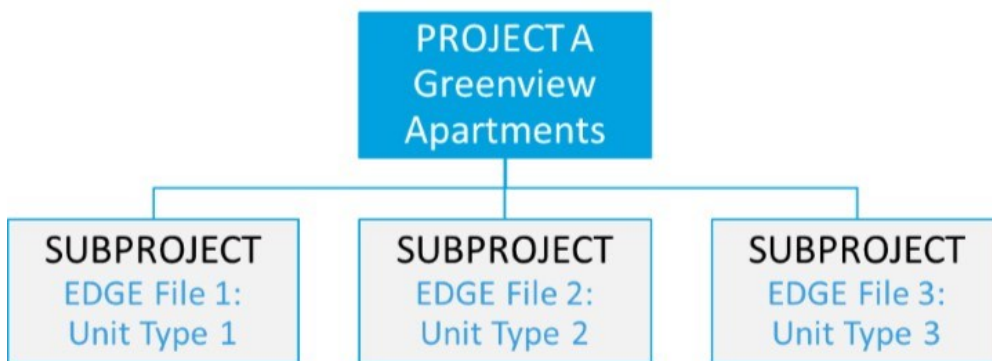

Figure 8. A Residential Project will typically have more than one Subproject.

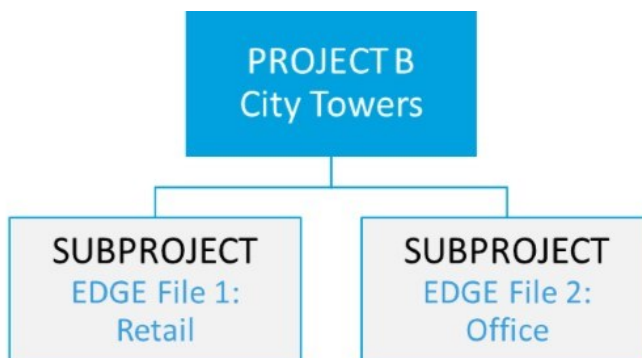

Figure 9. A Commercial project may also have one or more Subprojects.

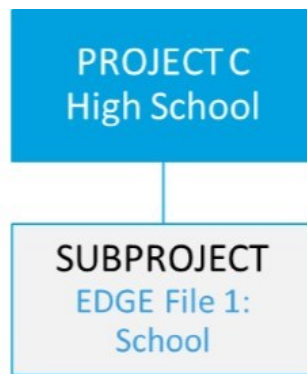

Figure 10. A Project can have a single Subproject if the whole building is modeled in the same EDGE file.

Project Details

This section contains the top-level information about the Project, such as owner name and contact information, and is shared across a Project's Subprojects. Changes to the Project Details section are automatically reflected in Subproject files. This section must be completed to submit the project for audit and certification.

- **Project Name*** – The name of the development. Note that this is a required field that serves as the project identifier. To edit the project name after saving, go to File > Rename on the Design tab. This option is no longer available to the Project Team after a project has been sent for audit. To change the name after a project has been sent for audit, please contact edge@ifc.org.
- **Number of Distinct Buildings** – The number of physical buildings that make up the whole project. This field is part of the project description that helps an auditor or reviewer understand the physical make-up of a project. This field helps account for the "number of buildings" certified by EDGE in a client's or auditor's portfolio. This value will be 1 for a single building, or for towers with a shared podium level. The value in this field is for information purposes only and is intended to help visualize the building during the quotation and certification process. The value does not get multiplied by the GIA, unlike the "Subproject Multiplier for the Project" (see the description of that field below under Subproject Details).
- **Project Owner Name** – The name of the key contact from the company/organization that commissioned the EDGE assessment.
- **Project Owner Email** – The email address of the key contact from the company/organization that commissioned the EDGE assessment.
- **Address Line 1** – Primary street address of the project.
- **Address Line 2** – Any additional details for the street address, such as the building number.
- **City** – The city where the project is located.
- **State/Province** – The state or province where the project is located.
- **Postal Code** – The postal code where the project is located (if applicable).

DESIGN PAGE GUIDANCE

- Country – The country where the project is located.
- Project Owner Phone* – The phone number of the key contact from the company/organization that commissioned the EDGE assessment.
- Do you intend to certify?* – Select Yes, No, or Not Sure, to indicate the intent regarding certification of the Subproject.
- Share with Investor(s) or Bank(s)?* - Select Yes, or No, to indicate preference. If a bank is interested in financing projects in the country, IFC will share a summary of the project and developer contact information with the bank. The bank may contact the developer directly.
- Number of EDGE Subproject(s) Associated – The total number of files associated with the Project. EDGE calculates this automatically based on the associations established by the user; therefore, this field is not editable by the user.
- Total Project Floor Area – The total square meters of internal area of the Project, including any indoor parking. This is the sum of the GIA of all the associated Subprojects within the Project. EDGE calculates the GIA automatically based on the areas and the *multipliers* (explained under “Subproject Multiplier for the Project”) assigned to each Subproject by the user; therefore, this field is not editable by the user. See GIA description under the “Area and Loads Breakdown” section.
- Project Number – This information field displays the system-assigned number for the project. It is not editable.
- Upload project-level documents – This button links to the location to upload whole project-level documents, for example, a site plan of the project.
- Download project audit documents – Clicking on this button downloads the entire set of project documents that have been uploaded thus far. Documents for individual measures are placed in their respective folders in the downloaded set. This allows project team members to access all project documents from one central location. This link is also used by the EDGE Auditor for project documentation review.
- “Register” button – The Register button appears once a project has been saved. EDGE now enables a whole project to be registered as one entity and triggers a quotation to be sent.
- “Associated Subprojects” – This link appears once a project has been saved. The link expands to show all the Subprojects associated with that Project in addition to the Subproject currently open in the EDGE App.

Subproject Details

This section contains fields associated only with the portion of the Project being described in the current file.

- Subproject Name* – The name of the project, or portion of the project, being modeled. This name will appear on the EDGE certificate, for example, “ABC Residential Towers”. This is a required field. The

DESIGN PAGE GUIDANCE

field remains editable until a Subproject has been sent for audit. To change the name after a Subproject has been sent for audit, please contact edge@ifc.org.

- **Building Name*** – The name of the building being modeled. For example, it may be the house or apartment block name in Homes or the property name in a Hotel building. This is a required field. The field remains editable before the final EDGE certificate is issued.
- **Subproject Multiplier for the Project*** – The Multiplier represents the number of times an entire Subproject is repeated in the Project. For example, if a Project has 5 identical warehouse buildings on a project site, the project team can model only one warehouse, and use 5 as the Multiplier. The default value is 1.
 - **Apartments:** To indicate the number of similar units in a residential apartment building, use the field “No. of Apartments” under Building Data. Do not use the Multiplier option.
 - **Homes:** To indicate the number of similar homes in a residential development, use the field “No. of Homes” under Building Data. Do not use the Multiplier option.
- **Certification Stage*** – The stage of certification of the project. Enter “Preliminary” for projects in the design stage of new construction or renovation. Enter “Post-Construction” for projects that have completed construction and are ready for the final verification phase of certification for new construction or renovation. For existing buildings applying for certification, “Post-Construction” is the default from the very beginning of the certification process, regardless of the length of time elapsed since construction. For example, an existing project built one month ago, or ten years ago, would both indicate “Post-Construction”. This is a required field.
- **Subproject Type** – The stage in the lifecycle of the building. “New Building” is the default and indicates new construction. “Existing Building” must be selected for existing buildings and renovations.
- **Year of Construction** – This field only applies to Existing Buildings. Enter the year the project was completed, that is, the year the project received the occupancy permit. If the project was completed before the earliest year available in EDGE, select the earliest year available and add a note in the Project Narrative section.

Subproject Address: This is the address that will appear on the EDGE certificate. The Subproject Address may or may not be the same as the Project Address. For example, if a Project has Subprojects in several locations around a city, each Subproject may have its own address.

- **Address Line 1*** – Primary street address of the subproject. This is a required field.
- **Address Line 2** – Any additional details for the street address, such as the building number
- **City*** – The city where the subproject is located. This is a required field.
- **State/Province** – The state or province where the subproject is located
- **Postal Code** – The postal code where the subproject is located if applicable

DESIGN PAGE GUIDANCE

- Country* – The country where the subproject is located. This is a required field.
- Status – The status of the project lifecycle. For example, self-review, registered etc.
- Auditor – The name of the Auditor assigned to the project
- Certifier – The Certification Provider for the project
- File Number – The system-assigned number for the unique Subproject file in EDGE (not editable)

Building Utility Data

This section only applies to Existing building projects; this section is optional. If these values are not available, a project can still apply for EDGE certification.

The intent of this section is to track the energy performance and water usage of the existing building that is applying for EDGE certification. The values can be taken from the most recent past year with typically expected levels of occupancy (e.g. 100% for an office, less than 100% for a hotel).

- Annual Measured Electricity Consumption – The recorded annual electricity usage of the subproject being modeled, expressed in kWh/year
- Annual Measured Water Consumption – The recorded annual water usage of the subproject being modeled, expressed in m³/year
- Annual Measured Natural Gas Consumption – The recorded annual natural gas usage of the subproject being modeled, expressed in m³/year
- Annual Measured Diesel Consumption – The recorded annual diesel usage of the subproject being modeled, expressed in kL/year
- Annual Measured LPG Consumption – The recorded annual usage of liquefied petroleum gas (LPG) of the subproject being modeled, expressed in kg/year

The following metrics for building performance are automatically calculated by the App.

- Existing Building Energy Performance Index (kWh/m²/Year)
- Existing Building Water Usage Index(m³/Person/Day)
- Existing Building GHG Emissions (tCO₂/Year)

Building Data, Area and Loads Breakdown

Building Data fields capture the physical make-up of the buildings in terms of total area, number of floors and floor height. The list of fields depends on the building type. The following fields are common to all building types.

DESIGN PAGE GUIDANCE

TIP: EDGE now allows users to model several typologies for apartments within the same file. To enter multiple unit types in a file, click on the Options menu for 'Multiple Typologies'.

- Built Up Area –The GIA of the Subproject being modeled, before it has been multiplied by the Subproject Multiplier.
- No. of Floors Above Grade - Total number of floors at and above the ground level. For buildings with a different number of floors in different areas, use the weighted average number of floors. For projects being modeled in sections with multiple EDGE models, the Floors field must only show the number of Floors that section represents.
 - For a mixed-use building, show the total number of floors including all uses.
 - For a mixed-use building using separate models, only show the number of floors being modeled in each type.
- No. of Floors Below Grade– Total number of floors below the ground level. The same logic applies as for Floors Above Ground (see immediately above) for a different number of floors in different areas.
- Floor-to-floor Height — Total floor-to-floor height, including the height of the slab. In the case of floors with false ceilings, this height is floor-to-ceiling. Use a weighted average for buildings with varying floor heights.
- Roof Area – This is the roof area of the Subproject. In a residential building, the input for this value is the total roof area for all the units being modeled.

Other fields are unique to certain building types:

- Total No. of Homes – Number of units within the building that are covered by the assessment. This will be the total number of units per typology being represented by that model. In the case of identical buildings that can use the same model, use the multiplier to represent the total units in the Project.
- Average House Area (m²) – Average internal area of a residential unit including occupied spaces, utility, balcony, and service shaft attached to a unit. This does not include common areas or external walls, and partition walls between individual units.
- No. of Bedrooms – Number of bedrooms in a home or apartment.

Operational Details

EDGE provides default values, when applicable. A user can update the values to match the model more closely to the building conditions. The Homes model does not include this field.

- Occupancy (People/Unit) – Average number of people that would typically reside in each dwelling. If this is unknown, use number of bedrooms + 1. For example, for a 3-bedroom unit, use 3+1 = 4.

Building Costs

EDGE provides default values, when applicable. A user can update the values to estimate payback.

DESIGN PAGE GUIDANCE

- Cost of Construction (per m²)
- Estimated Sale Value (per m²)

Gross Internal Area

The GIA field applies to every building type. This value represents the gross internal area of the subproject being modeled before it has been multiplied by the Subproject Multiplier. This value impacts savings calculations.

GIA is defined in EDGE as per the International Property Measurement Standards, Type 2 (IPMS2) definition of the Royal Institution of Chartered Surveyors (RICS) in the UK⁴.

- The total area (m²) must be measured from the inside of the external walls.
- Distances to interior walls are measured on center.
- Interior elements such as columns and interior walls are not excluded from the area.
- Balconies are included in the GIA, but their area must also be stated separately. For example, if a studio apartment has 40 m² interior conditioned space, with a 20 m² open balcony, the GIA is 60 m², with 20m² balcony.
 - Also included are external horizontal structures at any floor level of a building that are protected with a railing or parapet at the open sides — including generally accessible balconies, colonnades (with balustrade), rooftop terraces, external galleries, and loggias. These should all be indicated as Balcony areas and will count towards the GIA.
- Internal parking (on the building floor plates) is included in the GIA, but its area must also be stated separately.
- Areas outside the building(s) envelope, such as landscaped areas (gardens, patios, etc.) or outdoor parking areas are not included. For example, if a penthouse has a green roof which is not accessible to the occupants, it counts as a roof and does not get counted in the GIA. Also excluded are structures such as patios and Level 0 terraces when not integral to the structural construction of the building.

TIP: The GIA must match the value entered under Building Data, or the file will show an error. This serves to doublecheck the values entered. The GIA (m²) field is the sum of the space areas and must equal the Built-Up Area (m²) that the user entered in the Building Data section.

Individual Space Types

EDGE assigns to each space type in a model a default value (in m²) as a percentage of the gross internal area based on the type and subtype of building selected. If the actual area differs from the default, then it can be overwritten by providing a value in the "User Entry" field.

⁴ International Property Measurement Standards <https://www.rics.org/uk/upholding-professional-standards/sector-standards/real-estate/international-property-measurement-standards/>

DESIGN PAGE GUIDANCE

TIP: If a space type does not exist, enter a '0' to overwrite its default area value; otherwise, the default area value will be modeled.

Some space types are described below in **Table 3**.

Table 3: Definitions of select space types under Area Details

Space Type	Description
Guest Rooms/Apartment Area	A default value (m ²) is provided based on the property type. If the actual area differs from the default, then it can be entered here.
Recreational Area	Area of the guest amenities such as retail area, gymnasium, and indoor pool in Serviced Apartments.
Front of House	Area of lobby, restaurants, gymnasium and indoor pool etc. in Hotels and Resorts
Back of House	Includes all back of house functions such as kitchen, storage, and mechanical and electrical room.
Balcony	Open-to-air spaces with lighting but no air-conditioning
Staircase	This space type includes any circulation spaces such as staircases, corridor, and lift area
Enclosed Garage	Interior parking areas
Area with Exterior Lighting	Exterior area that is artificially lit with electric lights
External Carparking Area	Exterior parking area that is open to outside air (unenclosed)
Irrigated Area	Landscaped area on the project site that needs irrigation to be maintained
Exterior Swimming Pool	Swimming pool located outside the building interior
Anchor Store Area (Supermarket)	Area of the supermarket. For any other type of anchor store, use the next field.
Anchor Store Area (Other)	Area of the anchor store for any anchor store type except a supermarket.
Atrium	An entrance hall or central court with a high ceiling. Many shopping mall layouts have an atrium to ventilate and provide natural light to the common areas and corridors of the mall.
Bakery	Sales and preparation area including ovens for baked goods.
Supermarket	This option appears in the "department store" model, the "small food retail" model, and the "non-food big box retail" model, and refers to a supermarket within a retail complex. When the entire retail building is a supermarket, the "supermarket" model should be selected instead. In shopping malls, the supermarket is an option as the anchor store.
Changing Rooms	Rooms adjacent to the gymnasium or swimming pool for changing clothes, often equipped with showers
Workshops	Area of the rooms used as workshops such as for carpentry or theater

DESIGN PAGE GUIDANCE

Detailed Loads Input

To enter detailed space conditions and loads for each space in a building, click on the Options menu and access 'Detailed Loads Input'. This option, newly available in EDGE version 3, allows users to input unique internal conditions for each space type in a building. These inputs are not required; but they are available in case a project team wants to model unique conditions in a space.

TIP: As with all EDGE values, if these details are not edited by a user, the system will assume the default values. So, it is best practice to review and verify them.

Some of the options available are described below.

- Space Conditioning Type: No Conditioning Provided — This indicates that a space is not artificially heated or cooled. The EDGE App calculates the space conditioning requirements for the space as usual, but any associated energy required is shown as Virtual Energy in the Energy Chart.
- Space Conditioning Type: No Conditioning Required — This indicates a space that is not required to be maintained at comfort temperatures. This is rare, and only applies to certain types of spaces such as certain types of Dry Storage in Warehouses. The EDGE App does not calculate any associated energy use for space conditioning for these spaces.
- Default Heating and Cooling Set Point temperature — These values are visible for information only; the values are not editable in the EDGE App.
- Plug Loads (W/m²) — This value captures the electrical equipment present within a space. It is assumed that 100% of the heat from laptops and computers is added to the space. Schedules are assumed to be a product of occupied hours and usage factor.
- Process Loads (W/m²) — This value only applies to continuous processes such as may be seen in an Industrial building type for example. It is assumed that 5-10% of the heat from medical equipment and 20-30% of the heat from industrial machinery is added to the space. Schedules are assumed to be a product of occupied hours and usage factor.
- People Sensible Heat (W/person) — The sensible heat emitted by the people per hour in a space.
- People Latent Heat (W/person) — The latent heat emitted by the people per hour in a space.

Building Dimensions

The building dimensions inform the EDGE App about the shape and volume of the building being modeled. This impacts the heat transfer between the building and the outside air, and the energy used for space conditioning.

- Building Length (meters) — EDGE assigns an octagonal shape to a new building by default, with equal wall lengths in each of the eight main orientations. Using the closest orientations, a user must input the building lengths that reflect the actual building.

Tip: Users must input zero for any orientations that do not represent the building, otherwise EDGE will model the building with the default inputs.

- Façade Area Exposed to Outside Air (%) — This percentage represents the portion of the enclosing wall that is exposed to outside air. By default, this value assumes 100% exposure. However, if a façade is not exposed because it is shared with an adjacent property or a similar reason, it can be updated with the appropriate percentage. If a facade is fully shared, this value should be 0%, for a shared wall in a townhome for example.

DESIGN PAGE GUIDANCE

Building HVAC System

The information in this section is used to calculate the improved case performance for the project building.

- Select Input Type – Simplified Inputs or Detailed Inputs

When 'Simplified Inputs' is selected, assumptions on the heating and cooling periods are automatically calculated by EDGE based on the climate of the location. With the 'Detailed Inputs' selection, users can specify the cooling and heating period by month.

Simplified Inputs

- Does the building design include an AC system? – Select "Yes" if the building will be delivered with an air conditioning (AC) system, or "No" if air conditioning system will NOT be installed at the time of final EDGE certification. Air conditioning systems include roof-top units, through-the-wall unitary air conditioners, packaged air conditioning units and chillers. They do not include ceiling fans or natural ventilation.

If "No" is selected but EDGE predicts that the building is likely to require cooling, then the cooling load will be reflected as virtual energy. Virtual energy is described in the Building Systems section of the Design Page Guidance.

- Does the building design include a space heating system? – Select "Yes" if the building will be delivered with a space heating system at the time of final EDGE certification, or "No" if a heating system will NOT be installed. Space heating in EDGE refers to building-wide heating systems such as underfloor, radiant, heat-exchangers, permanent gas heaters, etc. and includes appliance heaters using gas or electricity. Space heating does not include wood or fossil fuel burning fireplaces.

If "No" is selected but EDGE predicts that the building is likely to require heating, then the heating load will be reflected as virtual energy. As mentioned previously, virtual energy is described in the Building Systems section of the Design Page Guidance.

- Does the building design include purchased chilled water and heating supply? — This input is used for District Heating and Cooling systems.
- Baseline — This indicates whether the EDGE model is using the EDGE baseline or an ASHRAE standard baseline (which applies to advanced economies).

Detailed Inputs

In this section, a user can specify the months of the year when cooling and heating is being provided. The options described in the Simplified Inputs section above still apply.

Fuel Usage

- Hot Water – The actual fuel used in the project must be selected from the dropdown menu. If a hot water system is not part of the project, "None" must be selected.

DESIGN PAGE GUIDANCE

- Space Heating – The actual fuel used in the project must be selected from the dropdown menu. If no space heating is being provided, this selection must be “None.”
- Generator – The actual fuel used in the project must be selected from the dropdown menu.
- % of Electricity Generation Using Diesel – This is the percentage of the annual average electricity consumption for the building that uses a diesel generator as the source for electricity. Update the value if the actual electricity generation from diesel is different than the default, otherwise the default value will be modeled in the EDGE App.
- Fuel Used for Cooking – The actual fuel used in the project must be selected from the dropdown menu.
- Cost Input (in local currency)
 - Electricity – Annual average cost of electricity per kilowatt-hour. The default cost for electricity appears for the selected country. Update the value if more accurate data is available.
 - Diesel – Annual average cost of diesel per liter.
 - Natural Gas – Annual average cost of natural gas per liter.
 - LPG – Annual average cost of natural gas per liter.
 - Water – Annual average cost of water per kilo-liter.
 - Conversion from USD [local currency/USD]

Climate Data

The monthly atmospheric values have been included for the cities available in EDGE for each country. Default climate data is based on meteorological data from the city location. It is understood that the monthly values for the project site may vary from the average temperatures for the city due to variation in microclimates. Therefore, users can update these values in EDGE to reflect their project location. If the project site is not within a listed city, then users may select a city close to it in geography and climate, and manually enter the monthly climate values for the project location.

If any values are updated, the project team must submit evidence with a source for the values for EDGE certification compliance. The following weather data sources are acceptable:

- A Test Reference Year (TRY) if the building location is within 50km of a TRY location; or,
- In the absence of local TRY weather data, an actual year of recorded weather data from a location within 50km of the building location; or,
- In the absence of TRY or actual weather data within 50km, interpolated data based upon three points within 250km of the building location.
- Weather data can be obtained using sources such as Meteonorm or Weather Analytics.

DESIGN PAGE GUIDANCE

All the data below have default values that can be overwritten by the user.

- Elevation
- Rainfall
- CO2 Emissions – EDGE provides a default emissions value in grams per kilowatt-hour (g/kWh) based on World Bank Group-approved emissions factors. Update the value if better data is available for the electricity grid serving the project location.
- Latitude
- ASHRAE Climate Zone
- Country Specific Climate Zone
- Temperature
 - Maximum and minimum for all months of the year
- Relative Humidity
 - Average for all months of the year
- Wind Speed
 - Average for all months of the year

GREEN MEASURES OVERVIEW

This section provides an overview of the policies related to efficiency measures in EDGE.

Base Case

The Base Case is the standard benchmark against which the proposed design is compared for EDGE certification. The base case values shown in the App are used to calculate the base case performance of a building.

EDGE defines the Base Case or “EDGE Baseline” as the ‘standard construction practice currently prevalent in a region (e.g., city, district, state) over the previous 3 years for the specific building type being evaluated’.

- In a region which has mandatory building energy, water, or materials codes, and where these codes are implemented in most of the new buildings being built in last 3 years, the relevant code serves as the Baseline. If the code is sufficiently implemented in a few cities or states, and not the rest, their baselines can be different.
- In a region where no such codes exist, or where they do exist but are not sufficiently enforced, EDGE uses the standard practices followed by the local construction industry as the Baseline. For example, if most low-income homes in a region have walls constructed using concrete blocks, that serves as the EDGE low-income homes baseline. Or, if most hospitals use double-pane windows, that serves as the EDGE baseline for hospitals in that region. These assumptions may be different for different income category homes, and across different building types, such as offices, hotels, and shopping malls.

To maintain the simplicity of EDGE, the Baseline incorporates broad trends and practices, and does not delve into the details of a specific building or technology unless that represents the normal/typical practice.

Baseline Types

The base case varies by building type and by location. Each location in EDGE is assigned one of the following four (4) baselines:

1. Country-customized baseline: Countries with distinct building materials or a strong national building energy or water code are reflected in the EDGE baseline
2. City-Customized baseline: Countries with uneven implementation of building energy code in cities, with some cities more stringent than others; or where cities have distinct building patterns because of weather variation have a baseline customized at the city level.
3. Global EDGE baseline: A global set of baseline parameters is used as the baseline for countries with emerging economies following typical global practices.
4. ASHRAE 90.1-2016: Advanced economies that typically follow a higher standard of construction have been assigned the ASHRAE 90.1-2016 baseline. Distinctions in aspects such as insulation are based on climate zones as per the ASHRAE standards.

EDGE uses the best available information for default values. Since energy and water prices can change with time or location, EDGE provides users with the ability to update the default values for a project. If any of the default base case values are overwritten, justification must be provided in the form of supporting documentation, including a link to any relevant local standards.

GREEN MEASURES OVERVIEW

It should be noted that certain baseline definition values are locked for general users and only accessible to admin users. For example, the baseline value for the heating system efficiency is visible but locked. These values can be updated if a different minimum efficiency is required by the building and energy codes or local mandates applicable to the project are in place. Please contact the EDGE Team to adjust these values, with relevant documentation to support the request. Examples include:

- Window-to-Wall Ratio – The proportion of total glazed area including frames to the gross area of the exterior wall. Glazed area may include windows, doors and curtain walls. The window-to-wall ratio in the Base Case reflects local building regulations or typical practice in the selected city.
- Solar Reflectivity for Walls and Roof– Also known as albedo, this is the percentage of the full solar spectrum that is reflected by the exterior finish on average over the year.
- U-value of Roof, Walls, and Glass– The conductance of the baseline building elements.
- Glass SHGC – The solar heat gain coefficient of the glazing (not including the frame).
- Cooling System – This is the default cooling system assigned by EDGE based on the selected building type and size and heating fuel as per ASHRAE guidelines (see Table 4).
- AC System Efficiency – This is the baseline COP value of the air conditioning system. It is based on the default efficiency of the assigned system as per Normative Appendix G (performance Rating Method) of the ASHRAE standard 90.1-2016.

GREEN MEASURES OVERVIEW

Table 4: Base Case System Type Selection⁵

Building type, Number of Floors and Gross Conditioned Floor Area	Climate zones 3B, 3C, AND 4 TO 8	Climate zones 0 to 3A
Residential	System 1 - PTAC	System 2 - PTHP
Public Assembly <11,000 m2	System 3 -PSZ-AC	System 4-PSZ-HP
Public assembly ≥11,000 m2	System 12—SZ-CV-HW	System 13—SZ-CV-ER
Heated-only storage	System 9—Heating and ventilation	System 10-Heating and Ventilation
Retail and 2 floors or fewer	System 3—PSZ-AC	System 4—PSZ-HP
Other residential and 3 floors or fewer and <2300 m2	System 3—PSZ-AC	System 4—PSZ-HP
Other residential and 4 or 5 floors and <2300 m2 or 5 floors or fewer and 2300 m2 to 14,000 m2	System 5—Packaged VAV with reheat	System 6—Packaged VAV with PFP boxes
Other residential and more than 5 floors or >14,000 m2	System 7—VAV with reheat	System 8—VAV with PFP boxes
Public Assembly <11,000 m2	System 3 -PSZ-AC	System 4-PSZ-HP

Notes:

1. Residential building types include dormitory, hotel, motel, and multifamily. Residential space types include guest rooms, living quarters, private living space, and sleeping quarters. Other building and space types are considered nonresidential.
2. Where attributes make a building eligible for more than one baseline system type, use the predominant condition to determine the system type for the entire building, except as noted in Section G3.1.1 of ASHRAE 90.1.-2016.
3. For laboratory spaces in a building having a total laboratory exhaust rate greater than 7100 L/s, use a single system of type 5 or 7 serving only those spaces.
4. For hospitals, depending on building type, use System 5 or 7 in all climate zones.
5. Public assembly building types include houses of worship, auditoriums, movie theaters, performance theaters, concert halls, arenas, enclosed stadiums, ice rinks, gymnasiums, convention centers, exhibition centers, and natatoriums.

⁵ Source: ASHRAE 90.1-2016. Table G3.1.1A

GREEN MEASURES OVERVIEW

Table 5: **Base Case System Descriptions**⁶

System No.	System Type	Fan Control	Cooling Type	Heating Type
1. PTAC	Packaged Terminal Air Conditioner	Constant Volume	Direct expansion	Hot water fossil fuel boiler
2. PTHP	Packaged Terminal Heat Pump	Constant Volume	Direct expansion	Electric heat pump
3. PSZ-AC	Packaged Rooftop Air Conditioner	Constant Volume	Direct expansion	Fossil fuel furnace
4. PSZ-HP	Packaged Rooftop Heat Pump	Constant Volume	Direct expansion	Electric heat pump
5. Packaged VAV with Reheat	Packaged Rooftop VAV with Reheat	VAV	Direct expansion	Hot water fossil fuel boiler
6. Packaged VAV with PFP Boxes	Packaged Rooftop VAV with Reheat	VAV	Direct expansion	Electric resistance
7. VAV with Reheat	VAV with Reheat	VAV	Chilled water	Hot water fossil fuel boiler
8. VAV with PFP Boxes	VAV with parallel fan-powered boxes and reheat	VAV	Chilled water	Electric resistance
9. Heating and ventilation	Warm air furnace, gas fired	Constant volume	None	Fossil fuel furnace
10. Heating and ventilation	Warm air furnace, electric	Constant volume	None	Electric resistance
11. SZ-VAV	Single-zone VAV	VAV	Chilled water	See note (b).
12. SZ-CV-HW	Single-zone system	Constant volume	Chilled water	Hot-water fossil fuel boiler
13. SZ-CV-ER	Single-zone system	Constant volume	Chilled water	Electric resistance

a. For purchased chilled water and purchased heat, see Table 4

b. For Climate Zones 0 through 3A, the heating type shall be *electric resistance*. For all other climate zones, the heating type shall be *hot-water fossil-fuel boiler*.

Notes:

1. Residential building types include dormitory, hotel, motel, and multifamily. Residential space types include guest rooms, living quarters, private living space, and sleeping quarters. Other building and space types are considered nonresidential.
2. Where attributes make a building eligible for more than one baseline system type, use the predominant condition to determine the system type for the entire building, except as noted in Section G3.1.1 of ASHRAE 90.1-2016.
3. For laboratory spaces in a building having a total laboratory exhaust rate greater than 7100 L/s, use a single system of type 5 or 7 serving only those spaces.
4. For hospitals, depending on building type, use System 5 or 7 in all climate zones.
5. Public assembly building types include houses of worship, auditoriums, movie theaters, performance theaters, concert halls, arenas, enclosed stadiums, ice rinks, gymnasiums, convention centers, exhibition centers, and natatoriums.

⁶ Source: ASHRAE 90.1-2016. Table G3.1.1B

GREEN MEASURES OVERVIEW

- Heating System – This is the default heating system assigned (see Table 5 above) based on the selected building type and size and heating fuel as per ASHRAE guidelines
- Heating System Efficiency – This is the baseline COP value of the heating system assigned in the field directly above. It is based on the default efficiency of the assigned system as per Appendix G Table 3.1.1-4 of the ASHRAE standard 90.1-2016. Contact the EDGE Team to update this value if a different level of performance is required by code.

Efficiency Measures

The selection of energy efficiency measures can have a significant impact on the resource demand of a building. When measures are selected, EDGE makes default assumptions on the typical improved performance over the base case. The results are shown in charts that compare the base case building with the improved case.

TIP: the default must be overwritten with actual values where applicable by editing the user input fields.

While onsite renewable energy and the collection of rainwater are not technically efficiency measures, they reduce the use of grid electricity and treated potable water respectively, contributing to the 20% efficiency savings target required to reach the EDGE standard. Other innovative measures impacting energy or water savings can be reported using a proxy measure and will be evaluated on a case-by-case basis.

The guidance for EDGE measures is divided into the subsections described below:

Energy

The energy chart shows a breakdown of the end uses that consume energy. The units are kWh/m²/year. This includes the energy from all fuels – including electricity, natural gas and diesel – converted to kilowatt-hours. Hovering on the bar graph sections displays more information about each section. Note that Figure 11 shows 'Virtual Energy' for cooling and fans because the building does not include a cooling system.

EDGE currently uses delivered energy (i.e., that paid for by the consumer) as the measure of efficiency, as it is a more consistent global indicator. The carbon dioxide emissions (global warming potential) related to delivered energy use is a more accurate measure of the impact of a building on the environment, so future versions of EDGE may consider using this alternative indicator.

Virtual Energy

The use of Virtual Energy is a key concept in EDGE. When there are no plans for HVAC to be installed in a building at the time of certification, EDGE calculates the energy that will be required to ensure human comfort on the premise that if the building design does not provide proper internal conditions and the space is uncomfortably hot or cold, eventually mechanical systems will be added to the building (in the form of individual air conditioning units, for example) to compensate for the lack of a space-conditioning system. This future required energy for comfort is demonstrated in EDGE as "virtual energy," articulated separately for ease of understanding.

While this virtual energy is not reflected in the utility costs, it is used by EDGE to determine the 20% improvement in energy efficiency required by EDGE. Therefore, virtual energy must be reduced in the same way that actual energy is reduced.

GREEN MEASURES OVERVIEW

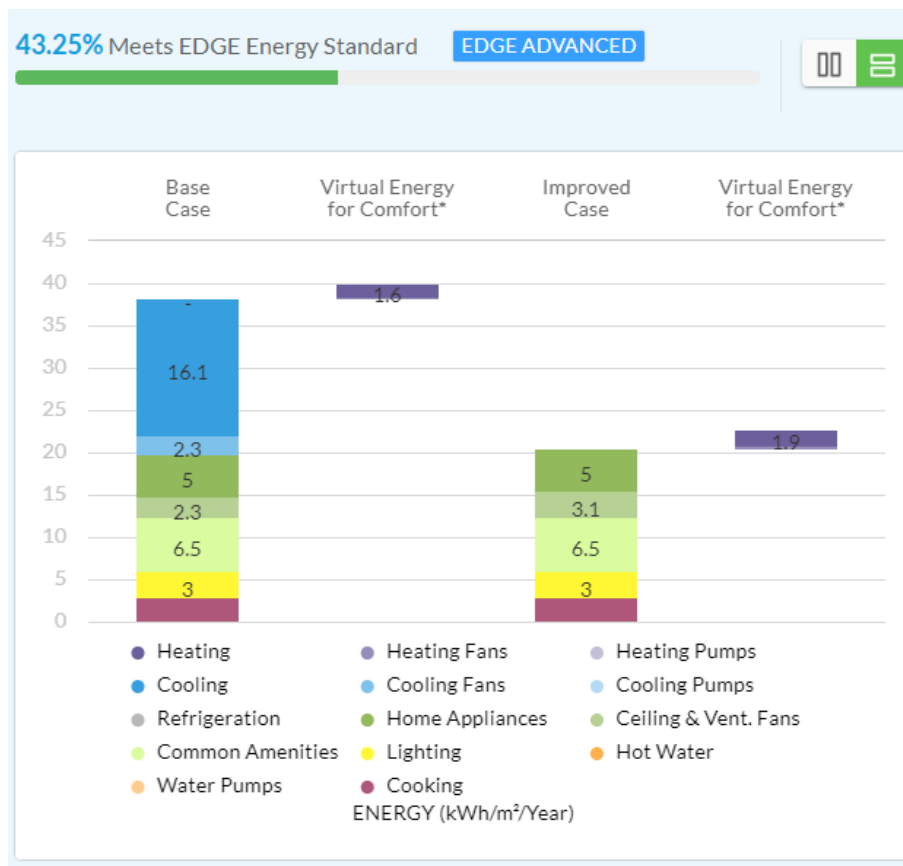

Figure 11. Sample Energy chart from the Apartments typology

The categories in the Energy Chart vary depending on the building type. A description of the categories follows.

- **Heating Energy, Cooling Energy and Fan Energy:** These reflect the energy used in the space conditioning systems. When a cooling or heating system is not specified, but the building requires it to maintain comfort, the estimated heating or cooling energy and its related fan energy show up as “virtual energy” on the Energy Chart. An example of virtual cooling and related fan energy is shown in Figure 11.
- **Catering: (Hospitality, Hospitals)** Includes cooking equipment, refrigerator, kitchen equipment and extractor hoods
- **Equipment, Lift, STP, Water Pumps: (Hospitals)** Includes plug loads, miscellaneous equipment, elevators, and sewage treatment plant (STP), and water pumps.
- **Food Court:** Includes cooking equipment, refrigerator, kitchen equipment and extractor hoods, as well energy required for the hot water for cooking.

It is only displayed if the ‘food court’ space type is selected as a facility in the design section. This space type only applies to professional kitchens and should not be made for small pantries such as those on office floors.

- **Home Appliances: (Homes)** Plug loads from common appliances

GREEN MEASURES OVERVIEW

- Hot Water: Energy consumed by the hot water system. Heating with any fuel type is converted to kWh.
- Laundry: This is the energy involved in washing and drying clothes.
- Lighting: This is the energy used for the lights.
- Pump Energy: Only includes pumps dedicated to the HVAC system.
- Refrigeration: (Retail) This is the energy involved in keeping the food refrigerated.
- Other: This includes plug loads, miscellaneous equipment, elevators, sewage treatment plant (STP) and water pumps.
- Common Amenities: (Homes) These include the sewage treatment plant (STP), water treatment plant (WTP), gray water treatment plant, water pumps for recreational facilities (such as a swimming pool), and the lift.

GREEN MEASURES OVERVIEW

Water

The water chart shows a breakdown of the end uses that consume water. The units are cubic meters per day. Hovering on the bar graph sections displays more information about each section.

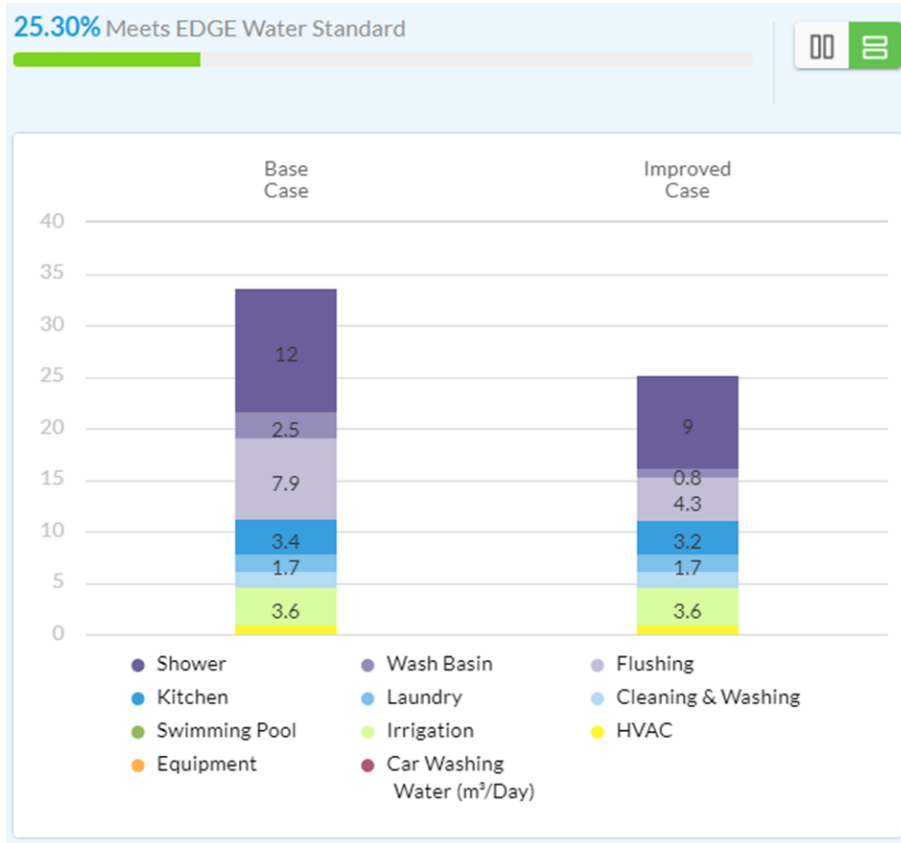

Figure 12. Sample Water Chart from the Apartments typology

The categories in the Water Chart vary depending on the building type. A description of the categories follows.

- Cafeteria: (Hospitality) This includes dishwashers, pre-rinse spray valves, kitchen sink, and water used for cooking and drinking in professional kitchens.
- Car Washing
- Cleaning and Washing
- Equipment
- Flushing
- Food Court / Kitchenette: (Offices) This includes dishwasher, pre-rinse valve, kitchen sink, water for drinking and cooking in professional kitchens.

GREEN MEASURES OVERVIEW

It is only displayed if the 'food court' space type is selected as a facility in the design section. This space type only applies to professional kitchens and should not be made for small pantries such as those on office floors.

- HVAC: (Retail, Offices, Hospitals, Education) This includes the water used for cooling and/or heating equipment.
- Irrigation
- Kitchen: (Retail, Hospitals) This includes dishwashers, pre-rinse spray valves, kitchen sink, water used for cooking and drinking.
- Laundry: (Hospitality, Hospitals) This includes cleaning the building, washing clothes, and car washing.
- Other: (Offices) This includes water for cleaning the building.
- Public Area: (Hospitality) This includes the water closets, urinals and faucets of the banquet hall, and employees and public areas of the hotel.
- Wash Basin
- Water Closets and Urinals
- Water Faucets
- Shower
- Swimming Pool

GREEN MEASURES OVERVIEW

Materials

A list of relevant specifications for each building element (roof, exterior walls, interior walls, floor finishes, etc.) appears in the Materials section. For each building element, a specification must be selected from the drop-down list that is most like the specification used in the design. Where there are multiple specifications for each building element, the predominant specification should be selected. Thicknesses must be indicated for floor slabs, roof construction, external walls and internal walls.

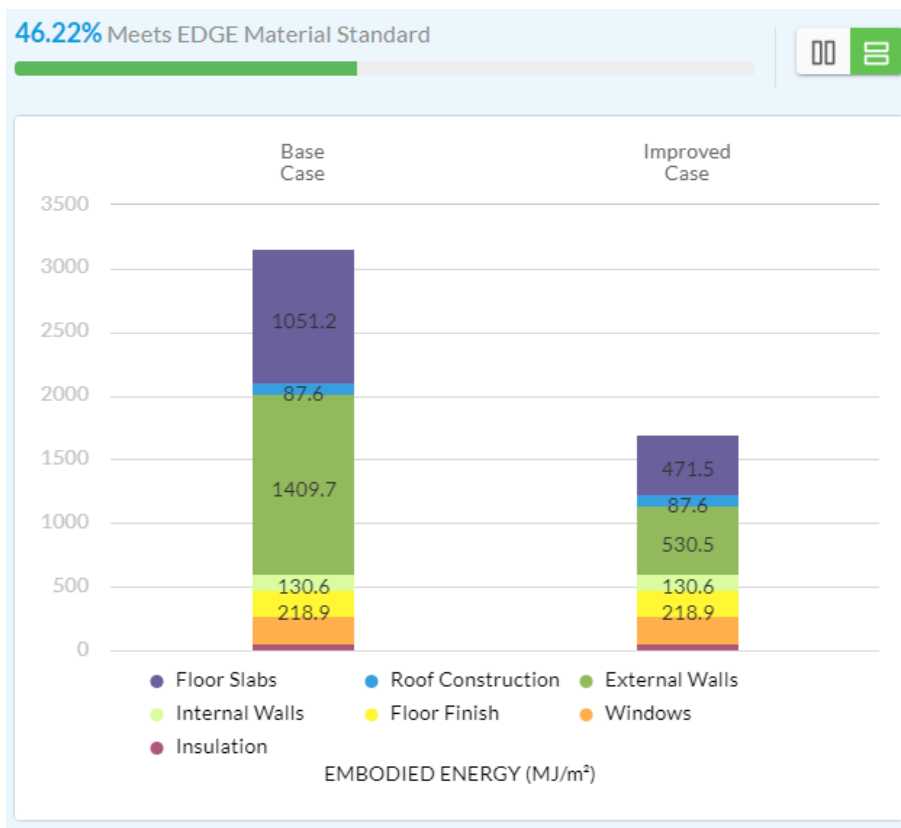

Figure 13. Sample Materials Chart from the Offices typology

As seen in Figure 13, the indicator used to measure materials efficiency is the embodied energy of the materials, which is the primary energy demand for its production. As with energy efficiency measures, future versions of EDGE may consider using carbon dioxide (global warming potential) as an indicator of materials efficiency as this more closely reflects the impact of the building on the environment.

INDIVIDUAL MEASURES IN EDGE

The Individual Measures Section in the user guide describes each measure included in EDGE, indicating the intent of the measure, how it is assessed, potential technologies and strategies to incorporate the measure, and what assumptions have been made to calculate the base case and improved case.

Requirement Summary

A summary of the system or level of performance required to claim that a measure has been incorporated into the project.

Intention

What the measure aims to achieve and why it is measured a certain way in EDGE.

Approach/Methodologies

The approach used to assess the design is provided with an explanation of the calculations and terminology used.

Note that EDGE makes default assumptions for a base case building. The key baseline values are displayed in the EDGE App. The base case is taken from either typical practice or performance levels required by applicable local codes and standards. An assumption is also made for the improved case, so that when a measure is selected the predicted performance of the building is improved.

TIP: It is typically possible to override the improved case assumptions in EDGE with more accurate levels of predicted performance for the actual building design. This allows actual improvements to be recognized.

Potential Technologies/Strategies

The possible solutions and technologies that might be considered by the design team to meet the requirements of the measure.

Relationship to Other Measures

EDGE calculates the impact of user-selected measures by taking a holistic view of the building project and assessing the impact on inter-related aspects of energy, water and materials (also known as integrated analysis). For example, a higher window-to-wall ratio may increase energy use and also increase embodied energy of the building envelope if the windows have higher embodied energy compared to the wall material. Another example is hot water; a reduction in hot water use would decrease the consumption of both water and the energy used to heat the water. Such inter-relationships between measures are listed in this section to clarify EDGE calculations and support the overall design process.

INDIVIDUAL MEASURES IN EDGE

Compliance Guidance

The compliance guidance provided for each measure indicates the documentation that will be required to demonstrate compliance for EDGE certification. Documentation requirements vary according to the technology being assessed.

Because available evidence depends on the current stage in the building design process, EDGE provides compliance guidance for each measure at both the design and post-construction stages. If the required evidence is not available during the design stage, a signed declaration of intent can be provided by the project administrator. Note that at the post-construction stage, this declaration must be signed by the client or a designated client representative as defined in the certification agreement. During the post-construction stage, more rigorous documentation is required. However, a common-sense approach is recommended to verify that the measure has indeed been installed as per the specifications claimed. For example, some measures require purchase receipts to demonstrate compliance. If these are not available, similar locally used documents such as drawings or invoices may be used instead to verify the construction details.

In the case of EDGE projects that are going directly into Post-Construction phase, the compliance requirements of both design and post-construction stages are expected to be met, except where a post-construction requirement replaces the design stage requirement.

In most cases, a minimum of 90% of a particular specification must comply for certification, unless specifically stated. If the auditor has reason to believe that a measure should be recognized, then proper justification should be provided for the certifier's review. Approval of such justification is at the discretion of the certifier.

ENERGY EFFICIENCY MEASURES

Energy efficiency is one of the three main resource categories that comprise the EDGE standard. To comply for certification purposes, the design and construction team must review the requirements for selected measures as indicated and provide the information.

Note: Efficiency values used in this User Guide to describe a measure are global baseline assumptions and may differ from values used in EDGE for countries in which it has been calibrated.

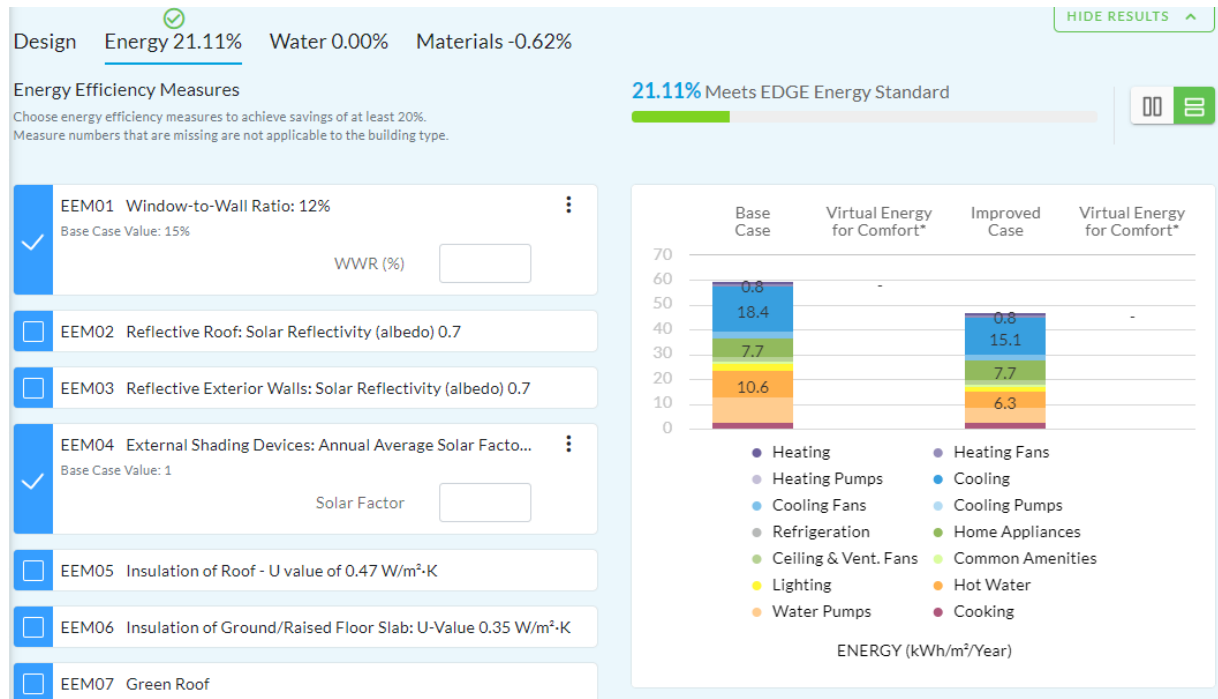

Figure 14. Screenshot of energy saving measures of one building type (Homes) in the EDGE App

The following pages explain each energy efficiency measure by relaying the intention, approach, assumptions, and compliance guidance requirements.

ENERGY EFFICIENCY MEASURES IN EDGE

EEM01* - WINDOW-TO-WALL RATIO

Requirement Summary

Window-to-Wall Ratio (WWR) should be selected and the WWR value entered in the EDGE App in all cases, irrespective of the value. Savings can be achieved if the Window to Wall Ratio is lower than the local Base Case.

Intention

The sun is a powerful light source but is also a source of significant heat gain. Therefore, it is important to balance lighting and ventilation benefits of glazing with the impacts of heat gain on cooling needs and/or passive heating. Finding the correct balance between the transparent (glass) and the opaque surfaces in the external façades helps to maximize daylight while minimizing unwanted heat transfer, resulting in reduced energy consumption. The design goal should be to meet minimum illumination levels without significantly exceeding the solar heat gains in temperate and warm climates, as well as to make the most of passive heating in cold climates in winter time.

Windows generally transmit heat into the building at a higher rate than walls do. In fact, windows are usually the weakest link in the building envelope as glass has much lower resistance to heat flow than other building materials. Heat flows out through a glazed window more than 10 times faster than it does through a well-insulated wall. While glazed areas are desirable to admit solar radiation in cold climates during the day, windows in warmer climates can significantly increase the building's cooling loads.

Approach/Methodologies

This measure uses the Window to Wall Ratio (WWR), which is defined as the ratio of the total area of the window or other glazing area (including mullions and frames) divided by the gross exterior wall area.

The WWR is calculated with the following equation:

$$WWR (\%) = \frac{\sum \text{Glazing area (m}^2\text{)}}{\sum \text{Gross exterior wall area (m}^2\text{)}}$$

Glazing area is the area of glass on all façades regardless of orientation. Gross exterior wall area is the sum of the area of the exterior façades in all orientations, which includes walls, windows and doors. To calculate the exterior wall area, the interior surface of the exterior wall must be used to determine the lengths.

The actual WWR for the design case must be entered in the system. While a higher WWR may have a negative impact on energy savings, it can be compensated for by other energy saving measures.

The improved case WWR must be calculated and entered for each façade separately, i.e. for the North Façade the % WWR of the North façade only should be entered. This will impact the solar gain in each façade and impact the cooling and heating load.

For projects with multiple subprojects with multiple EDGE files, the recommended method is to calculate an average WWR for the whole building and use that in every subproject. Modeling each subproject with its own WWR is also acceptable, but unless a significant difference exists between the subprojects with some containing double height spaces or very different glass areas, this approach is not recommended. For example, if the average WWR of a residential building is 35%, that will be used for all unit types regardless of their individual WWR. (However, individual window opening sizes will be considered for the natural ventilation measure).

ENERGY EFFICIENCY MEASURES IN EDGE

Windows and walls facing internal courtyards or gaps between buildings (open to outside air) should be included in the WWR calculations.

Spandrel panels (opaque insulated glass panels) should be included as external walls in the WWR calculations.

The following examples should be excluded from the calculations of WWR:

- a) Walls with windows/ventilation openings into interior shafts only (for example, as seen for bathrooms in residential projects in India)
- b) Any external wall that is not directly exposed to the environment. For example, underground walls, earth-bermed walls or walls in direct contact with another building
- c) Walls that do not enclose interior spaces. This includes walls that have more than 30% of the area as a permanent opening for ventilation. The next enclosing wall should be used instead.
- d) Openings that are only ventilation openings (without glazing)

Potential Technologies/Strategies

A building with a higher WWR will transfer more heat than a building with a lesser WWR. If the WWR is higher than the default value, then other measures such as shading or a lower solar heat gain coefficient (SHGC) of the glass should be considered to offset the energy loss. In cold climates, when the WWR is higher than the default, the insulation of glass using double or triple glazing should be considered.

With regards to daylight, two basic strategies are available for using the sun for lighting while minimizing heat gain. The first is to use a small window opening (15% WWR) to illuminate a surface inside the space that then spreads the light out over a large area. The second is to use a moderately sized window (30% WWR) that "sees" an exterior reflective surface but is shaded from the direct sun. To increase the daylight availability, the selection of higher visible light transmittance (VLT>50) for the glass is also important.

Relationship to Other Measures

Envelope heat transfer is a function of the thermal resistance of the external materials, the area of the building façade, and the temperature difference between the exterior and interior of the building. The primary causes of heat transfer are infiltration and windows. The size, number and orientation of windows have a significant effect on the building's energy use for thermal comfort purposes (heating or cooling).

In cold climates, direct solar radiation passes through the glass during the day, passively heating the interior. If sufficient thermal mass is used, this heat is then released, helping to keep the room comfortable later in the day. In this climate type, the glass placement that is most desirable is at the elevation with the greatest exposure to sunlight. However, in warm and temperate climates, the WWR should be lower as the reduction of glass leads to a reduction in the overall cooling load and reduced need for air conditioning.

It is important to consider that lighting and cooling energy use can be reduced using daylighting. This should be balanced with the corresponding solar and convective heat gains.

ENERGY EFFICIENCY MEASURES IN EDGE

Compliance Guidance

At the post-construction stage, it is important to ensure that the WWR has been maintained to achieve the energy savings indicated in the EDGE results. Compliance is achieved when the design team can demonstrate that the WWR in all elevations is equal or lower than the claimed specification, using the formula explained in “Potential Technologies/Strategies” above.

Design Stage	Post-Construction Stage
<p>At the design stage, the following must be used to demonstrate compliance:</p> <ul style="list-style-type: none">• Calculation of “Glazing Area” and “Gross Exterior Wall Area” for each façade of the building, and the average area-weighted WWR; and• All façade elevation drawings showing glazing dimensions and general building dimensions.	<p>At the post-construction stage, the following must be used to demonstrate compliance:</p> <ul style="list-style-type: none">• Documents from the design stage if not already submitted. Include any updates made to the documents to clearly reflect As-Built conditions; and• As-built façade drawings; or• Date-stamped photographs of the building interior and exterior showing all the elevations. <p>Existing building projects</p> <ul style="list-style-type: none">• If the documents required above are not available, other evidence of construction details, such as existing building drawings or photos taken during renovation can be submitted.

ENERGY EFFICIENCY MEASURES IN EDGE

EEM02 - REFLECTIVE ROOF

Requirement Summary

This measure can be claimed if the solar reflectance index (SRI) of the roof is greater than the local base case. EDGE will calculate the impact of any improvement beyond the base case. This measure is an advantage in warm climates.

Intention

Specifying a higher reflectance finish for the roof can reduce the cooling load in air-conditioned spaces and improve thermal comfort in non-air-conditioned spaces. Due to the reduction in surface temperature, the service life of the finish also improves, and the impact on the urban heat island effect⁷ can be reduced.

Approach/Methodologies

EDGE uses the solar reflectance index (SRI) of the roof finish as the indicator of performance. SRI represents a combination of the reflective properties of the surface when subject to incident solar radiation (total solar reflectivity), and the emittance properties of the surface (thermal emittance). Unlike Visible Solar Reflectance, SRI includes the full solar spectrum.

Solar Reflectivity (SR or albedo) is the fraction of sunlight (0 to 1, or 0 percent to 100 percent) that is reflected from a surface. SR typically ranges from about 0.04 (or 4 percent) for charcoal to 0.9 (or 90 percent) for fresh snow. Conversely, Solar Absorptance (SA) is the fraction of sunlight (0 to 1, or 0 percent to 100 percent) that is absorbed by a surface. Surfaces with high solar absorptance tend to get hot in the sun. If the surface is opaque, solar absorptance equals 1 minus solar reflectance.

Cool roofs come in many colors.

Many roof materials in any color can be treated with a reflective coating, giving them a higher solar reflectance than the standard version of that material.

Standard Concrete Tiles (SR)	0.04	0.18	0.24	0.33	0.17	0.12
With Cool Coating Applied (SR)	0.41	0.44	0.44	0.48	0.46	0.41

Figure 15. Source: Coolroof toolkit⁸

⁷ A city's core temperature is often significantly higher than its surrounding area due to the retention of heat from the built environment.

⁸ https://www.coolrooftoolkit.org/wp-content/pdfs/CoolRoofToolkit_Full.pdf

ENERGY EFFICIENCY MEASURES IN EDGE

Thermal Emittance (TE) is the efficiency (0 to 1) with which a surface emits thermal radiation. High thermal emittance helps a surface cool by radiating heat to its surroundings. Nearly all nonmetallic surfaces have high thermal emittance, usually between 0.80 and 0.95. Uncoated metal has low thermal emittance, which means it will stay warm. An uncoated metal surface that reflects as much sunlight as a white surface will stay warmer in the sun because it emits less thermal radiation⁹.

Solar Reflectance Index is a composite value accounting for a surface's solar reflectance and thermal emittance. SRI is defined so that a standard black surface (solar reflectance 0.05, thermal emittance 0.90) is 0 and a standard white surface (solar reflectance 0.80, thermal emittance 0.90) is 100. SRI values for highly reflective roofs have been engineered to go above 100. The SRI for a specific roofing material and finish can be acquired from the product manufacturer. It is often indicated in the product data sheet or laboratory test results published on manufacturers' websites. SRI is typically expressed as a fractional value between 0 and 1. It can also be expressed as a percentage.

- To model more than one roof finish, weighted average values must be used.
- If a portion of the roof is a Green Roof, the SRI value in EDGE will only apply to the portion that is not the green roof.
- If the SR and emittance of a roof surface ARE known, but the SRI is not known, it can be calculated using [this calculator](#) by the Lawrence Berkeley National Laboratory, Berkeley, CA, USA.

Potential Technologies/Strategies

High solar reflectance is the most important property of a cool surface. Color is the key factor in the solar reflectivity of the material or finish. In warm climates, a white finish is ideal to maximize reflectivity. A very light color would be the next best choice. Cool roof coatings can significantly increase the reflectance of a roof, even for dark colors, and therefore increase the SRI. Thermal Emittance (TE) is the second most important property of a cool surface. SRI captures both solar reflectance and thermal emittance. High SRI values can be achieved by virtue of the material, color, coating, or a combination of those. Table 6 provides an indication of the SRI values for different roof finishes but is meant only as a guide. Manufacturers' published values must be used in the EDGE assessment. If manufacturer data is not available, EDGE reference values may be used.

Table 6: Solar reflectance Index (SRI) values for typical roofing materials¹⁰

Roofing Materials	SRI
Bitumen	
Firestone SBS Bitumen on White	28
Smooth Bitumen	1 (use 0)

⁹ Cool roof toolkit: https://www.coolrooftoolkit.org/wp-content/pdfs/CoolRoofToolkit_Full.pdf

¹⁰ Source: Adapted from the LBNL Cool Roofing Materials Database. These values are for reference only and are not for use as substitutes for actual manufacturer data.

ENERGY EFFICIENCY MEASURES IN EDGE

Roofing Materials	SRI
White Granular Surface Bitumen	28
Asphalt Shingles¹¹	
White Asphalt	26
Light Gray	22
Light Gray – with cool coating	44
Gray	4
Beachwood Sand	19
Light Brown	18
Saddle Tan	14
Black or Dark Brown	1
Black – with cool coating	41
Blue	16
Blue – with cool coating	50
Coral	14
Terracotta-colored	36
Terracotta-colored – with cool coating	56
Green	18
Green – with cool coating	53
Chocolate	9
Chocolate – with cool coating	46

¹¹ <https://heatisland.lbl.gov/resources/asphalt-shingles>

ENERGY EFFICIENCY MEASURES IN EDGE

Roofing Materials	SRI
Metal Roof	
Metal roof – Uncoated	68
Bare Aluminum	56
New, Bare Galvanized Steel	46 ¹²
Metal roof – with Cool Coating	92
White Metal Roof	82
Built-up Roof	
Dark Gravel on Built-Up Roof	9
Light Gravel on Built-Up Roof	37
White-Coated Gravel on Built-Up Roof	79
Roof Tiles	
Red Clay Tile	36
Red Concrete Tile	17
Unpainted cement Tile	25
White Concrete Tile	90
Light Beige-coated Concrete Tile	76
Light Brown-coated Concrete Tile	48
Earth Brown Fiber Cement Tile	27
Pewter Gray Fiber Cement Tile	25

¹² <https://heatisland.lbl.gov/resources/metal-roofing>

ENERGY EFFICIENCY MEASURES IN EDGE

Roofing Materials	SRI
EPDM	
EPDM ¹³ - Gray	21
EPDM – White	84
EPDM - Black	-1 (use 0)
T-EPDM	102
Roof Coatings¹⁴	
White Coating (2 coats, 20 mils*)	107
White Coating (1 coat, 8 mils*)	100
No Pigment Coating (1 coats, 18 mils*)	40
No Pigment Coating (2 coats, 36 mils*)	64

* mil is equal to .001 inches or .0254 millimeter

Relationship to Other Measures

The impact that the solar reflectivity of the roof has on the energy consumption of a building is dependent upon the insulation levels and the approach used to cool the building, as well as the efficiency of any cooling systems.

The solar reflectivity of the roof finish has a decreased effect on the internal heat gains as the insulation levels are increased. Super-insulated buildings may not benefit significantly from roof finishes with a high solar reflectivity. Higher solar reflectivity values will have no effect on the energy consumption in passively cooled buildings, but may have an impact on virtual energy and, therefore, EDGE results due to occupant comfort.

As the efficiency of the cooling system increases, the solar reflectivity will have a decreasing impact on energy consumption.

If the roof area is a useable area (i.e. for roof activities), then the use of bright white colors is not recommended as they can cause glare and discomfort.

¹³ <https://heatisland.lbl.gov/resources/roofing-membranes>

¹⁴ <https://heatisland.lbl.gov/resources/roof-coatings>

ENERGY EFFICIENCY MEASURES IN EDGE

Compliance Guidance

At both the design and post-construction stage, it is important to ensure that the value obtained for the roof material/finish is the solar reflectivity of the finish rather than an alternative indicator of performance. Solar reflectivity is also referred to as solar reflectance (R). Other values that may be provided by a manufacturer include the solar reflectance index (SRI), visible solar reflectance, the emittance, or gloss units, which are not the same as solar reflectivity.

Design Stage	Post-Construction Stage
<p>At the design stage, the following must be used to demonstrate compliance:</p> <ul style="list-style-type: none">• Building plans marking the area of major roof types if more than one type of roof is present; and• Building design drawings showing the roof finish(es). Where the finish is white, this measure can be awarded without further evidence;• If finish is not white, provide one of the following with the solar reflectivity of the roof surface clearly indicated,<ul style="list-style-type: none">○ Roof specifications; or○ Manufacturer’s data sheets, or○ Bill of quantities.	<p>At the post-construction stage, the following must be used to demonstrate compliance:</p> <ul style="list-style-type: none">• Documents from the design stage if not already submitted. Include any updates made to the documents to clearly reflect As-Built conditions; and• Date-stamped photographs of the roof(s) showing the claimed products on site; or• Purchase receipts showing the installed products. <p>Existing building projects</p> <ul style="list-style-type: none">• If the documents required above are not available, other evidence, such as existing building drawings or photos taken during renovation can be submitted.

EEM03 – REFLECTIVE EXTERIOR WALLS

Requirement Summary

This measure can be claimed if the solar reflectance index (SRI) of the external wall finish is greater than the local base case. EDGE will calculate the impact of any improvement beyond the base case. This measure is recommended in warm climates.

Intention

Specifying a higher SRI finish for the walls can reduce the cooling load in air-conditioned spaces and improve thermal comfort in non-air-conditioned spaces. Due to the reduction in surface temperature, the service life of the finish also improves, and the impact on the urban heat island effect¹⁵ can be reduced.

Approach/Methodologies

EDGE uses the solar reflectance index (SRI) of the exterior finish as the indicator of performance. SRI represents a combination of the reflective properties of the surface when subject to incident solar radiation (total solar reflectivity), and the emittance properties of the surface (thermal emittance). Unlike Visible Solar Reflectance, SRI includes the full solar spectrum.

Solar Reflectance Index is a composite value accounting for a surface's solar reflectance and thermal emittance. SRI is defined so that a standard black surface (solar reflectance 0.05, thermal emittance 0.90) is 0 and a standard white surface (solar reflectance 0.80, thermal emittance 0.90) is 100. SRI values for highly reflective surfaces have been engineered to go above 100. The SRI for a specific material and finish can be acquired from the product manufacturer. It is often indicated in the product data sheet or laboratory test results published on manufacturers' websites. SRI is typically expressed as a fractional value between 0 and 1. It can also be expressed as a percentage.

Solar Reflectivity (SR or albedo) is the fraction of sunlight (0 to 1, or 0 percent to 100 percent) that is reflected from a surface. SR typically ranges from about 0.04 (or 4 percent) for charcoal to 0.9 (or 90 percent) for fresh snow. Conversely, Solar Absorptance (SA) is the fraction of sunlight (0 to 1, or 0 percent to 100 percent) that is absorbed by a surface. Surfaces with high solar absorptance tend to get hot in the sun. If the surface is opaque, solar absorptance equals 1 minus solar reflectance.

Thermal Emittance (TE) is the efficiency (0 to 1) with which a surface emits thermal radiation. High thermal emittance helps a surface cool by radiating heat to its surroundings. Nearly all nonmetallic surfaces have high thermal emittance, usually between 0.80 and 0.95. Uncoated metal has low thermal emittance, which means it will stay warm. An uncoated metal surface that reflects as much sunlight as a white surface will stay warmer in the sun because it emits less thermal radiation¹⁶.

¹⁵ A city's core temperature is often significantly higher than its surrounding area due to the retention of heat from the built environment.

¹⁶ Cool roof toolkit: https://www.coolrooftoolkit.org/wp-content/pdfs/CoolRoofToolkit_Full.pdf

ENERGY EFFICIENCY MEASURES IN EDGE

Potential Technologies/Strategies

The key consideration of the material used on the façade is its color and potential solar reflectivity.

Table 7 provides an indication of the ranges for different materials but is meant only as a guide. Manufacturers' published values must be used in the EDGE assessment. If manufacturer data is not available, the EDGE reference values may be used as an exception.

Table 7: **Solar reflectivity of typical wall finishes**¹⁷

Wall Materials	SRI
Metal – with Cool Coating	92
White Metal	82
Red Clay Brick	36
Red Concrete	17
Unpainted cement	25
White-painted Concrete	90

Relationship to Other Measures

The impact that the solar reflectivity of the walls has upon the energy consumption in a building is dependent on the insulation levels, as well as the approach used to cool the building and the efficiency of any cooling systems.

The solar reflectivity of the wall finish has a decreased effect on the internal heat gains as the insulation levels are increased. Super-insulated buildings may not benefit significantly from wall finishes with a high solar reflectivity. Higher solar reflectivity values will have no effect on the energy consumption in passively cooled buildings but may have an impact on the EDGE rating due to occupant comfort.

As the efficiency of the cooling systems increases, the solar reflectivity will have a decreasing impact on reducing the energy consumption.

A highly reflective surface might cause glare and should be taken into consideration by the design team.

¹⁷ Ranges are taken from various manufacturers' websites.

ENERGY EFFICIENCY MEASURES IN EDGE

Compliance Guidance

At both the design and post-construction stage it is important to ensure that the value obtained for the wall material/finish is the solar reflectivity of the finish rather than an alternative indicator of performance. Other values that may be provided by a manufacturer include the solar reflectance index (SRI), visible solar reflectance, the emittance or gloss units, which are not the same as solar reflectivity.

Design Stage	Post-Construction Stage
<p>At the design stage, the following must be used to demonstrate compliance:</p> <ul style="list-style-type: none">• Building plans or elevations highlighting the area of major external wall types if more than one type of external wall is present; and• Building design drawings showing the wall finish(es). Where the finish is white, this measure can be awarded without further evidence;• If finish is not white, provide one of the following with the solar reflectivity of the wall surface clearly indicated,<ul style="list-style-type: none">○ Wall specifications; or○ Manufacturer’s data sheets, or○ Bill of quantities.	<p>At the post-construction stage, the following must be used to demonstrate compliance:</p> <ul style="list-style-type: none">• Documents from the design stage if not already submitted. Include any updates made to the documents to clearly reflect As-Built conditions; and• Date-stamped photographs of the wall(s) showing the claimed products on site; or• Purchase receipts showing the installed products. <p>Existing building projects</p> <ul style="list-style-type: none">• If the documents required above are not available, other evidence of construction details, such as existing building drawings or photos taken during renovation can be submitted.

EEM04 – EXTERNAL SHADING DEVICES

Requirement Summary

This measure can be claimed if external shading devices are provided on the building's exterior.

Intention

External shading devices are provided on the building façade to protect the glazed elements (glass windows and doors) from direct solar radiation to reduce glare and to reduce radiant solar heat gain in cooling dominated climates. This method is more effective than internal shading devices such as blinds. This is because radiant solar gain occurs in the form of short wavelengths that can pass through glass; however, radiation absorbed by surfaces in the room is emitted as long-wavelength radiation, which cannot escape back out through the glass because almost all window glass is opaque to long-wavelength radiation. This traps the radiant solar gain inside the room. This phenomenon is known as the greenhouse effect.

Approach/Methodologies

If this measure is selected, EDGE uses a default shading factor equivalent to that of a shading device that is 1/3 of the height of the window and 1/3 of the width of the window on all windows of the building. However, if shading devices are provided that are different from EDGE assumptions, then a different shading factor should be used. The shading factor varies according to the latitude and the orientation of the windows, as well as the size of the shading device, and can be calculated using the built-in calculator. Figure 16 illustrates the dimensions used to calculate the shading factor.

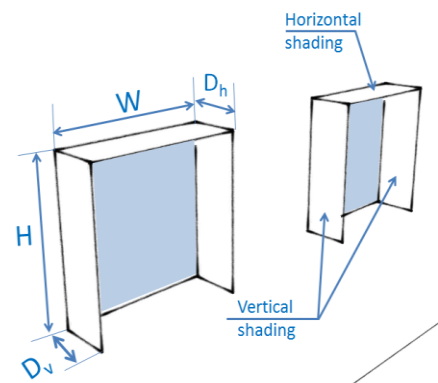

Figure 16. Illustration of the dimensions used to calculate the shading factor

Table 8, Table 9, and Table 10 show the relationship between the Dh and Dv (depth of horizontal and vertical shading) H (window height) and W (window width) to determine the shading factor.

This measure is assessed using an Annual Average Shading Factor, which is represented by one minus the ratio of solar radiation transmitted by a protected window (with external shading devices), compared to that transmitted by an unprotected window.

Annual Average Shading Factor (AASF) is defined by following equation:

$$\text{AASF} = 1 - \frac{\text{Total annual solar heat gain from a window with shading (kWh)}}{\text{Total annual solar heat gain from a window without shading (kWh)}}$$

The shading factor is expressed as a decimal value between 0 and 1. The higher the shading factor, the greater is the shading capability of the shading device.



ENERGY EFFICIENCY MEASURES IN EDGE

Table 8, Table 9, and Table 10 indicate the shading factors for different orientations, latitudes, and shading device proportions. The last column of Table 10 lists the average shading factor for the combined type, which is used as the default improved case by EDGE.

The project AASF is the area-weighted average of the shading factors of all the external windows. When conducting calculations, all windows should be accounted for. If a window has a vertical and a horizontal overhang with different depths, select the more conservative (smaller factor) overhang depth for the calculation. If any windows do not have an overhang, they must still be included in the calculation and use the appropriate values for 'No Overhang.' The total Window Area must match the total External Window Area used in WWR calculations.

Table 8: Shading factors for horizontal shading devices at different latitudes for each orientation

*The shading factors have been derived using a solar modelling tool

HORIZONTAL - SHADING FACTOR* (Shading Coefficient)										
N (North), NE (North East), E (East), SE (South East), S (South), SW (South West), W (West), NW (North West)										
Latitude	Shading Proportion	Shading Factor								
Northern Hemisphere		N	NE	E	SE	S	SW	W	NW	Average
Southern Hemisphere		S	SE	E	NE	N	NW	W	SW	
0° - 9°	$D_h = H/1$	0.49	0.46	0.49	0.50	0.50	0.52	0.52	0.48	0.50
	$D_h = H/2$	0.44	0.39	0.39	0.40	0.46	0.43	0.41	0.41	0.42
	$D_h = H/3$	0.39	0.34	0.32	0.33	0.39	0.36	0.34	0.35	0.35
	$D_h = H/4$	0.35	0.29	0.27	0.28	0.33	0.31	0.28	0.30	0.30
10° - 19°	$D_h = H/1$	0.47	0.44	0.47	0.51	0.51	0.52	0.49	0.47	0.48
	$D_h = H/2$	0.42	0.38	0.38	0.40	0.43	0.42	0.41	0.41	0.40
	$D_h = H/3$	0.36	0.33	0.31	0.32	0.35	0.35	0.34	0.35	0.34
	$D_h = H/4$	0.32	0.29	0.26	0.27	0.30	0.30	0.30	0.32	0.29
20° - 29°	$D_h = H/1$	0.47	0.44	0.47	0.50	0.51	0.52	0.50	0.46	0.48
	$D_h = H/2$	0.41	0.38	0.37	0.39	0.41	0.41	0.40	0.41	0.40
	$D_h = H/3$	0.36	0.33	0.31	0.32	0.34	0.34	0.34	0.35	0.33
	$D_h = H/4$	0.31	0.28	0.26	0.26	0.29	0.29	0.28	0.31	0.29
30° - 39°	$D_h = H/1$	0.47	0.43	0.46	0.49	0.51	0.51	0.49	0.46	0.48
	$D_h = H/2$	0.41	0.37	0.36	0.38	0.40	0.40	0.39	0.40	0.39
	$D_h = H/3$	0.36	0.32	0.29	0.30	0.33	0.32	0.33	0.35	0.32
	$D_h = H/4$	0.31	0.28	0.25	0.25	0.28	0.27	0.28	0.31	0.28
40° - 49°	$D_h = H/1$	0.46	0.39	0.40	0.43	0.46	0.46	0.45	0.44	0.44
	$D_h = H/2$	0.40	0.34	0.31	0.33	0.36	0.36	0.37	0.39	0.36
	$D_h = H/3$	0.35	0.29	0.25	0.26	0.29	0.29	0.30	0.33	0.30
	$D_h = H/4$	0.31	0.25	0.21	0.21	0.23	0.24	0.26	0.29	0.25
50° - 60°	$D_h = H/1$	0.33	0.30	0.34	0.38	0.40	0.39	0.36	0.32	0.35
	$D_h = H/2$	0.24	0.23	0.24	0.26	0.28	0.26	0.25	0.24	0.25
	$D_h = H/3$	0.18	0.18	0.18	0.19	0.20	0.19	0.19	0.19	0.19
	$D_h = H/4$	0.15	0.14	0.14	0.15	0.16	0.15	0.15	0.15	0.15

For the base case, EDGE assumes that no solar shading is present. For the improved case, EDGE assumes a shading factor equivalent to shading devices with a proportion of 1/3 of the height and the width of the window, fitted to all windows.

ENERGY EFFICIENCY MEASURES IN EDGE

Table 9: Shading factors for vertical shading devices at different latitudes for each orientation





VERTICAL - SHADING FACTOR* (Shading Coefficient)										
N (North), NE (North East), E (East), SE (South East), S (South), SW (South West), W (West), NW (North West)										
Latitude	Shading Proportion	Shading Factor								
Northern Hemisphere		N	NE	E	SE	S	SW	W	NW	Average
Southern Hemisphere		S	SE	E	NE	N	NW	W	SW	
0° - 9°	$D_v=W/1$	0.23	0.23	0.18	0.22	0.23	0.20	0.18	0.21	0.21
	$D_v=W/2$	0.21	0.19	0.15	0.18	0.22	0.17	0.15	0.18	0.18
	$D_v=W/3$	0.19	0.16	0.12	0.15	0.19	0.14	0.12	0.15	0.15
	$D_v=W/4$	0.16	0.14	0.11	0.12	0.16	0.12	0.11	0.13	0.13
10° - 19°	$D_v=W/1$	0.21	0.24	0.20	0.20	0.23	0.18	0.20	0.21	0.21
	$D_v=W/2$	0.19	0.21	0.16	0.16	0.21	0.15	0.17	0.19	0.18
	$D_v=W/3$	0.17	0.18	0.14	0.13	0.17	0.14	0.15	0.16	0.15
	$D_v=W/4$	0.15	0.16	0.12	0.11	0.15	0.12	0.13	0.15	0.13
20° - 29°	$D_v=W/1$	0.22	0.25	0.20	0.21	0.24	0.19	0.20	0.22	0.21
	$D_v=W/2$	0.19	0.21	0.16	0.17	0.20	0.16	0.17	0.19	0.18
	$D_v=W/3$	0.17	0.18	0.13	0.14	0.17	0.14	0.14	0.17	0.15
	$D_v=W/4$	0.15	0.15	0.12	0.11	0.14	0.12	0.12	0.15	0.13
30° - 39°	$D_v=W/1$	0.21	0.26	0.22	0.21	0.24	0.19	0.21	0.23	0.22
	$D_v=W/2$	0.19	0.22	0.17	0.16	0.19	0.16	0.18	0.20	0.19
	$D_v=W/3$	0.17	0.19	0.14	0.13	0.16	0.14	0.15	0.17	0.16
	$D_v=W/4$	0.15	0.16	0.12	0.11	0.14	0.11	0.13	0.15	0.13
40° - 49°	$D_v=W/1$	0.23	0.28	0.24	0.24	0.25	0.23	0.22	0.24	0.24
	$D_v=W/2$	0.20	0.23	0.19	0.17	0.20	0.18	0.19	0.21	0.20
	$D_v=W/3$	0.18	0.19	0.15	0.14	0.16	0.15	0.16	0.17	0.16
	$D_v=W/4$	0.16	0.16	0.13	0.11	0.14	0.13	0.14	0.15	0.14
50° - 60°	$D_v=W/1$	0.26	0.30	0.27	0.27	0.27	0.26	0.27	0.28	0.27
	$D_v=W/2$	0.20	0.22	0.20	0.18	0.20	0.19	0.21	0.21	0.20
	$D_v=W/3$	0.16	0.17	0.16	0.14	0.15	0.15	0.16	0.16	0.16
	$D_v=W/4$	0.13	0.14	0.13	0.11	0.12	0.12	0.13	0.13	0.13

Table 10: Shading factors for combined shading devices (both horizontal and vertical) at different latitudes for each orientation



COMBINED - SHADING FACTOR (Shading Coefficient)										
N (North), NE (North East), E (East), SE (South East), S (South), SW (South West), W (West), NW (North West)										
Latitude	Shading proportion	Shading Factor								
Northern Hemisphere		N	NE	E	SE	S	SW	W	NW	Average
Southern Hemisphere		S	SE	E	NE	N	NW	W	SW	
0° - 9°	$D_h=H/1$ & $D_v=W/1$	0.72	0.69	0.67	0.72	0.74	0.73	0.70	0.70	0.71
	$D_h=H/2$ & $D_v=W/2$	0.65	0.59	0.54	0.58	0.68	0.60	0.56	0.60	0.60
	$D_h=H/3$ & $D_v=W/3$	0.58	0.50	0.45	0.48	0.58	0.51	0.47	0.51	0.51
	$D_h=H/4$ & $D_v=W/4$	0.51	0.43	0.38	0.41	0.50	0.43	0.39	0.44	0.44
10° - 19°	$D_h=H/1$ & $D_v=W/1$	0.69	0.69	0.67	0.71	0.74	0.70	0.70	0.68	0.70
	$D_h=H/2$ & $D_v=W/2$	0.60	0.59	0.54	0.56	0.64	0.57	0.59	0.60	0.59
	$D_h=H/3$ & $D_v=W/3$	0.53	0.51	0.45	0.45	0.53	0.49	0.50	0.52	0.50
	$D_h=H/4$ & $D_v=W/4$	0.47	0.45	0.39	0.38	0.45	0.42	0.43	0.46	0.43
20° - 29°	$D_h=H/1$ & $D_v=W/1$	0.69	0.69	0.68	0.71	0.75	0.71	0.70	0.69	0.70
	$D_h=H/2$ & $D_v=W/2$	0.61	0.59	0.54	0.56	0.62	0.57	0.57	0.60	0.58
	$D_h=H/3$ & $D_v=W/3$	0.53	0.51	0.44	0.46	0.51	0.48	0.48	0.52	0.49
	$D_h=H/4$ & $D_v=W/4$	0.47	0.44	0.38	0.38	0.43	0.41	0.41	0.46	0.42
30° - 39°	$D_h=H/1$ & $D_v=W/1$	0.69	0.69	0.68	0.71	0.75	0.70	0.70	0.69	0.70
	$D_h=H/2$ & $D_v=W/2$	0.60	0.59	0.53	0.55	0.60	0.56	0.57	0.61	0.58
	$D_h=H/3$ & $D_v=W/3$	0.53	0.51	0.44	0.44	0.49	0.47	0.48	0.52	0.48
	$D_h=H/4$ & $D_v=W/4$	0.47	0.44	0.37	0.36	0.41	0.39	0.41	0.46	0.41
40° - 49°	$D_h=H/1$ & $D_v=W/1$	0.69	0.68	0.64	0.68	0.71	0.69	0.68	0.68	0.68
	$D_h=H/2$ & $D_v=W/2$	0.61	0.57	0.50	0.50	0.56	0.54	0.56	0.59	0.55
	$D_h=H/3$ & $D_v=W/3$	0.53	0.49	0.41	0.40	0.45	0.44	0.47	0.51	0.46
	$D_h=H/4$ & $D_v=W/4$	0.47	0.42	0.35	0.32	0.37	0.37	0.40	0.45	0.39
50° - 60°	$D_h=H/1$ & $D_v=W/1$	0.62	0.63	0.63	0.66	0.68	0.66	0.65	0.62	0.64
	$D_h=H/2$ & $D_v=W/2$	0.53	0.51	0.48	0.48	0.51	0.49	0.51	0.53	0.50
	$D_h=H/3$ & $D_v=W/3$	0.43	0.42	0.38	0.37	0.39	0.38	0.41	0.43	0.40
	$D_h=H/4$ & $D_v=W/4$	0.36	0.34	0.31	0.29	0.31	0.30	0.34	0.36	0.33

ENERGY EFFICIENCY MEASURES IN EDGE

Potential Technologies/Strategies

Three basic types of solar shading are used most commonly: horizontal, vertical, and combined (egg crate).

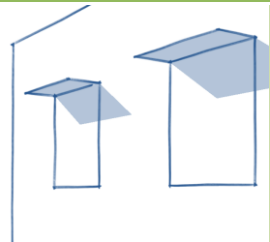
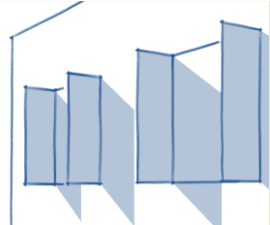
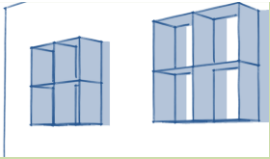
Table 11: Typical shading devices

Shading Type	Image	Description
Horizontal shading devices (overhangs):		<p>These are useful for building façades where the sun’s rays are at a high angle of incidence, in short, where the sun appears high in the sky.</p> <p>Examples include summer mid-day sun on either the northern or southern façades of a building for higher latitudes, or east and west façades for equatorial latitudes.</p>
Vertical shading devices (fins):		<p>These applications are useful where the sun’s rays are at a low angle of incidence (where the sun appears low in the sky).</p> <p>Examples include eastern sun on eastern façades, western sun on western façades, and winter sun on southern or northern façades in high latitudes.</p>
Combined shading devices (egg crate):		<p>“Egg crate” devices are used for conditions where different times of the year warrant different shading needs.</p>
Moveable shading devices – louvres or shutters		<p>These devices are used to control sunlight during the day as well as reduce heat losses at night. They are moveable and can be mechanical or manual. They often provide maximum shading as they fully cover the window.</p> <p>These shading devices also protect from inclement weather (hail, wind, or rain) as well as provide privacy and security.</p>

The effectiveness of a shading device varies depending on the location towards the equator (latitude) and the orientation of the window.

Table 12 gives a preliminary indication of the appropriate type of shading device for each orientation.

Table 12: Shading strategies for different orientations at the design stage.

ORIENTATION	EFFECTIVE SHADING
Equator-facing	Fixed Horizontal Device
East	Vertical Device/Louvres (moveable)
Pole-facing	Not required
West	Vertical Device/Louvres (moveable)

ENERGY EFFICIENCY MEASURES IN EDGE

Example:

An office building in Istanbul (Turkey) has 1-meter-deep horizontal shading on 3 meters high windows in all directions. What is the shading factor for these windows?

The shading factor can be calculated with the built-in calculator in the EDGE software online. If calculating the factor manually, use the following steps:

Step one is to determine the latitude of Istanbul (41 N) from the EDGE online tool design tab.

Step two is to use the table provided for Horizontal shading (Table 8) and look for the matching latitude category which is "40° to 49°". As the shading is 1/3rd of the window height, " $D_v=H/3$ " should be selected. The average shading factor is 0.30.

Step three is to select external shading measure in the EDGE App and input 0.30 into the average annual shading factor (AASF) field.

Relationship to Other Measures

External shading reduces the heat gain through solar radiation, therefore a glazing type with a higher solar heat gain coefficient can be selected without a significant negative impact. As external shading cuts the solar heat before it hits the glazed element, it reduces radiative heat gain compared to a treated glass without shading, thus offering better thermal comfort conditions.

Shading reduces heat gain and, therefore, cooling loads. The extent of the savings achieved in cooling energy from shading will be impacted by the efficiency of the cooling system. With a more efficient cooling system, the magnitude of savings from shading alone will be less, even though the combined savings will be greater.

In heating mode, the heating consumption may be increased when external shading is incorporated, due to the reduction of solar heat gains in winter, if shading is not well designed. Well-designed shading cuts out the summer sun but allows in the winter sun which is at a lower altitude.

ENERGY EFFICIENCY MEASURES IN EDGE

Compliance Guidance

The information required to demonstrate compliance will depend on the design solution adopted. The simplest design approach is the installation of egg crate shading devices (depth of 1/3 the height and the width) on all windows on all façades. Design teams may prefer to specify the shading device according to the orientation. Table 8, Table 9, Table 10, and Table 11 can be used as guidelines for different sizes and types of shading devices and orientation. Compliance is achieved when the design team has correctly entered the average of the shading factor of all orientations. In the case of external movable shades, the design team can select a Combined Overhang with the greatest projection (W/1 and H/1). In the instance that the building has a more complex shading design, the design team can use specialized software that uses the AASF equation given in the approach section above, to demonstrate that average shading factors have been achieved.

Design Stage	Post-Construction Stage
<p>At the design stage, the following must be used to demonstrate compliance:</p> <ul style="list-style-type: none"> • All façade elevation drawings highlighting the provision of horizontal and vertical shading devices; and • Window details clearly showing the depth of the shading device and the calculation of the proportion. 	<p>At the post-construction stage, the following must be used to demonstrate compliance:</p> <ul style="list-style-type: none"> • Documents from the design stage if not already submitted. Include any updates made to the documents to clearly reflect As-Built conditions; and • Date-stamped photographs of all facades showing the shading devices on site; or • Purchase receipts showing the installed products. <p>Existing building projects</p> <ul style="list-style-type: none"> • If the documents required above are not available, other evidence of construction details, such as existing building drawings or photos taken during renovation can be submitted.

ENERGY EFFICIENCY MEASURES IN EDGE

EEM05* – INSULATION OF ROOF

Requirement Summary

This measure refers to the U-value or thermal conductivity of materials as the indicator of performance, in which the use of insulation improves the U-value. The user must select the measure for 'Insulation of the Roof' in the Energy tab when the measure is marked with an asterisk. The U-value must be entered following the guidelines in the Approach/Methodologies section. Note that the measure for 'Roof insulation' must also be selected in the Materials tab, and the actual insulation type and thickness entered.

Savings from the measure can be claimed if the U-value of the roof is lower than the base case U-value.

Intention

Insulation is used to prevent heat transmission from the external environment to the internal space (for warm climates) and from the internal space to the external environment (for cold climates). Insulation aids in the reduction of heat transmission by conduction¹⁸, so more insulation implies a lower U-value and better performance. A well-insulated building has lower cooling and/or heating energy requirements.

Please note that many modern insulating materials, such as certain foam-based insulations, as well as air cavities that improve the sustainability and energy efficiency of buildings also spread fire more easily compared to traditional materials such as concrete and wood. The project team is encouraged to take proper fire safety precautions in the selection of these materials and the associated design details such as fire stops.

Approach/Methodologies

This measure uses U-value, which is defined as the quantity of heat that flows through a unit area in unit time, per unit difference in temperature; it is expressed in Watts per square meter Kelvin (W/m^2K). U-value is an indication of how much thermal energy (heat) is transmitted through a material (thermal transmittance). The U-value, which is the performance indicator of this measure, is the reciprocal of the total thermal resistance¹⁹ ($1/\sum R$) of the roof, which is calculated from the individual thermal resistance of each component/layer of the roof.

If the default improved case is used, the design team must demonstrate that the U-value of the roof does not exceed the U-value assumed by EDGE (see assumptions below). This can be obtained by the manufacturer or by the "simple method" calculation, explained as follows. If a different U-value for the roof is used, then it must be calculated with the following formula or in accordance with the "combined method"²⁰ given in ISO 6946. For multiple roof types with different U-values, use an area-weighted average.

¹⁸ Conduction is the process by which thermal energy moves within an object or between connected objects.

¹⁹ Thermal resistance is a measure of how much heat loss is reduced through the given thickness of a material. Thermal resistance is expressed as the R, which is measured in square meters Kelvin per Watt (m^2K/W).

²⁰ Several websites give worked examples for the calculation of the U-value according to the "combined method:"

ENERGY EFFICIENCY MEASURES IN EDGE

Simple method of calculating the U-value:

$$U - Value = \frac{1}{R_{si} + R_{so} + R_1 + R_2 + R_3 \text{ etc}}$$

Where: R_{si} = Resistance of the air layer on the inner side of the roof (add constant of air)

R_{so} = Resistance of the air layer on the external side of the roof

$R_1, 2 \text{ etc.}$ = Resistance of each material layer within the roof

The resistance of a roof material is derived by the following formula: $R = \frac{d}{\lambda}$

Where: d = Thickness of the layer of material (m)

λ = Thermal conductivity²¹ in W/m K

As seen in the formula above, the insulating capacity is a direct function of the thickness of the material. Table 13 demonstrates how to achieve a U-value of 0.45W/m² K with certain insulation materials. The actual thickness required will depend on many other factors, including the fixing method, roof construction and position of the insulation within the material layers. The U-value calculation must include the green roof portion.

Table 13: Thickness of insulation required to achieve a U-value of 0.45 W/m² K²²

Insulation Type	Thickness (mm)	Thermal Conductivity
	Approximate values to achieve a U-value of 0.45W/m ² K	(W/m K)
Vacuum Insulated Panels	10 - 20mm	0.008
Polyurethane (PU)	40 - 80mm	0.020 - 0.038
Polyisocyanurate (PIR)	40 - 60mm	0.022 - 0.028
Phenolic Foam (PF)	40 - 55mm	0.020 - 0.025
Expanded Polystyrene (EPS)	60 - 95mm	0.030 - 0.045
Extruded Polystyrene (XPS)	50 - 80mm	0.025 - 0.037
Wool and Fiberglass	60 - 130mm	0.030 - 0.061

1. Conventions for U-value calculations, Brian Anderson, BRE, 2006. [http://www.bre.co.uk/filelibrary/pdf/rpts/BR_443_\(2006_Edition\).pdf](http://www.bre.co.uk/filelibrary/pdf/rpts/BR_443_(2006_Edition).pdf)
2. Worked examples of U-value calculations using the combined method, The Scottish Government, 2009 - <http://www.scotland.gov.uk/Resource/Doc/217736/0088293.pdf>
3. Determining U-values for real building elements, CIBSE - <http://www.cibsejournal.com/cpd/2011-06/>

²¹ Thermal conductivity is a standardized measure of how easily heat flows through any specific material, independent of material thickness. It is measured in Watts per meter Kelvin (W/m K), and is often expressed as the "K Value" or "λ".

²² Source: Insulation Materials Chart, Energy Savings Trust, 2004.

ENERGY EFFICIENCY MEASURES IN EDGE

EDGE provides a built-in calculator for calculating the U-value of a roof with multiple layers of materials layered on top of each other. For more complex assemblies, for example, if the materials are not in continuous layers or metal penetrations punctuate the roof, dedicated U-value calculation software or energy modelling software can also be used.

Potential Technologies/Strategies

Insulating the roof is potentially the most cost-effective way to reduce the energy used for heating a building. Therefore, in cold or temperate climates there is a strong case for maximizing the insulation before designing the heating ventilation and air conditioning equipment. In hot climates insulating the roof can reduce heat gain, but the effect is relatively minor.

Different types of insulation are available, and the appropriate type will depend on the application as well as cost and availability. Insulation types can be grouped into four main categories, as shown in Table 14.

Table 14. Insulation types and typical conductivity range

Insulation Type	Description	Typical Conductivity Range (λ - K Value)
Matting, Blanket, or Quilt Insulation	This type of insulation is sold in rolls of different thicknesses and is typically made from mineral wool (fiber made from glass or rock). Some common uses include insulating empty lofts, stud walls, and under suspended timber floors. Other materials such as sheep's wool are also available.	0.034 – 0.044
Loose-fill Material	Loose-fill material, made of cork granules, vermiculite, mineral wool, or cellulose fiber is usually poured between the joists to insulate lofts. It is ideal for loft spaces with awkward corners or obstructions, or if the joists are irregularly spaced.	0.035 – 0.055
Blown Insulation	Blown insulation is made from cellulose fibers or mineral wool. Spray foam insulation is made from Polyurethane (PUR). Blown insulation should only be installed by professionals, who use special equipment to blow the material into a specific, sectioned-off area, to the required depth. The material may remain loose if used for loft insulation but can also bond to a surface (and itself) for insulating stud walls and other spaces.	0.023 – 0.046
Rigid Insulation Boards	Rigid insulation boards are mostly made from foamed plastic such as polystyrene, polyurethane (PUR), or polyisocyanurate (PIR), which can be used to insulate walls, floors, and ceilings. PUR and PIR board are among the best insulation materials commonly used, and so are useful where space is limited. Rigid board must be cut to size, so fitting is often a skilled job.	0.02 – 0.081

The range of thermal conductivity can be used by auditors and reviewers to check for reasonableness of the project team's claims about insulation properties. It can also be used as a substitute in the rare case when manufacturer data is not available.

ENERGY EFFICIENCY MEASURES IN EDGE

Relationship to Other Measures

Selecting this measure will show an increase in the environmental impact in the materials section due to the addition of insulation material (reflected as a negative percent improvement).

However, by increasing the level of insulation the heating and/or cooling loads will be reduced. Increasing the levels of insulation could therefore reduce the cost and environmental impact of the heating and cooling plant, leading to energy savings that compensate for the negative impacts in the materials section while providing thermal comfort.

Compliance Guidance

To claim savings from this measure, it is necessary to demonstrate that the U-value of the complete roof specification is better (lower) than the Base Case. If the EDGE default for the improved case U-value is used, then it is only necessary to demonstrate that insulation has been or will be installed, and that its U-value does not exceed the default improved case value. The U-value is the reciprocal of the sum of the R-values for each component of the roof structure.

If a U-value has been entered that exceeds the improved case, then it is necessary to confirm that the U-value was calculated in accordance with the "combined method" given in ISO 6946 as shown in the Approach/Methodologies above.

Design Stage	Post-Construction Stage
<p>At the design stage, the following must be used to demonstrate compliance:</p> <ul style="list-style-type: none">• Building plans highlighting the area of major roof types if more than one type of roof is present; and• Detailed drawing(s) showing the layers of roof materials and any U-value specifications; and• Calculation of overall roof U-value using either the calculator provided in the EDGE measure or external calculations; and• Manufacturer's data sheets for the specified building materials; or• Bill of quantities with the specifications for any roof insulation materials clearly highlighted.	<p>At the post-construction stage, the following must be used to demonstrate compliance:</p> <ul style="list-style-type: none">• Documents from the design stage if not already submitted. Include any updates made to the documents to clearly reflect As-Built conditions; and• Date-stamped photographs of the roof(s) taken during construction at a point when any insulation materials claimed were visible on site; or• Purchase receipts showing the installed products. <p>Existing building projects</p> <ul style="list-style-type: none">• If the documents required above are not available, other evidence of construction details, such as existing building drawings or photographs can be submitted.

EEM06* – INSULATION OF GROUND/RAISED FLOOR SLAB

Requirement Summary

This measure refers to the U-value or thermal conductivity of materials as the indicator of performance, in which the use of insulation improves the U-value. The U-value must be entered following the guidelines in the Approach/Methodologies section. Note that the corresponding insulation measure must also be selected in the Materials tab, and the actual insulation type and thickness entered.

Intention

Insulation is used to prevent heat transmission from the external environment to the internal space (for warm climates) and from the internal space to the external environment (for cold climates). Insulation aids in the reduction of heat transmission by conduction²³, so more insulation implies a lower U-value and better performance. A well-insulated building has lower cooling and/or heating energy requirements.

Please note that many modern insulating materials, such as certain foam-based insulations, as well as air cavities that improve the sustainability and energy efficiency of buildings also spread fire more easily compared to traditional materials such as concrete and wood. The project team is encouraged to take proper fire safety precautions in the selection of these materials and the associated design details such as fire stops.

Approach/Methodologies

This measure uses U-value, which is defined as the quantity of heat that flows through a unit area in unit time, per unit difference in temperature; it is expressed in Watts per square meter Kelvin (W/m^2K). U-value is an indication of how much thermal energy (heat) is transmitted through a material (thermal transmittance). The U-value, which is the performance indicator of this measure, is the reciprocal of the total thermal resistance²⁴ ($1/\Sigma R$) of the roof, which is calculated from the individual thermal resistance of each component/layer of the roof.

If the default improved case is used, the design team must demonstrate that the U-value of the roof does not exceed the U-value assumed by EDGE (see assumptions below). This can be obtained by the manufacturer or by the "simple method" calculation, explained as follows. If a different U-value for the roof is used, then it must be calculated with the following formula or in accordance with the "combined method"²⁵ given in ISO 6946. For multiple roof types with different U-values, use an area-weighted average.

²³ Conduction is the process by which thermal energy moves within an object or between connected objects.

²⁴ Thermal resistance is a measure of how much heat loss is reduced through the given thickness of a material. Thermal resistance is expressed as the R, which is measured in square meters Kelvin per Watt (m^2K/W).

²⁵ Several websites give worked examples for the calculation of the U-value according to the "combined method:"

4. Conventions for U-value calculations, Brian Anderson, BRE, 2006. [http://www.bre.co.uk/filelibrary/pdf/rpts/BR_443_\(2006_Edition\).pdf](http://www.bre.co.uk/filelibrary/pdf/rpts/BR_443_(2006_Edition).pdf)
5. Worked examples of U-value calculations using the combined method, The Scottish Government, 2009 - <http://www.scotland.gov.uk/Resource/Doc/217736/0088293.pdf>
6. Determining U-values for real building elements, CIBSE - <http://www.cibsejournal.com/cpd/2011-06/>

ENERGY EFFICIENCY MEASURES IN EDGE

Simple method of calculating the U-value:

$$U - Value = \frac{1}{R_{si} + R_{so} + R_1 + R_2 + R_3 \text{ etc}}$$

Where: R_{si} = Resistance of the air layer on the inner side of the roof (add constant of air)

R_{so} = Resistance of the air layer on the external side of the roof

$R_{1,2 \text{ etc.}}$ = Resistance of each material layer within the roof

The resistance of a roof material is derived by the following formula: $R = \frac{d}{\lambda}$

Where: d = Thickness of the layer of material (m)

λ = Thermal conductivity²⁶ in W/m K

As seen in the formula above, the insulating capacity is a direct function of the thickness of the material. Table 13 demonstrates how to achieve a U-value of 0.45W/m² K, with the thickness of certain insulation materials indicated. The actual thickness required will depend on many other factors, including the fixing method, roof construction and position of the insulation within the material layers.

Potential Technologies/Strategies

Insulating the floor reduces the energy used for heating a building in a cold or temperate climate. There is a strong case for maximizing the insulation before designing the heating, ventilation, and air conditioning equipment.

²⁶ Thermal conductivity is a standardized measure of how easily heat flows through any specific material, independent of material thickness. It is measured in Watts per meter Kelvin (W/m K), and is often expressed as the "K Value" or " λ ".

ENERGY EFFICIENCY MEASURES IN EDGE

Different types of insulation are available. Insulation types can be grouped into four main categories, as shown in Table 15. The appropriate type of insulation for a floor will depend on whether it is on grade or underground (for which waterproof insulation boards are best), or raised above the ground (for which batt or blown insulation would also work).

Table 15. Insulation types and typical conductivity range

Insulation Type	Description	Typical Conductivity Range (λ - K Value)
Matting, Blanket, or Quilt Insulation	This type of insulation is sold in rolls of different thicknesses and is typically made from mineral wool (fiber made from glass or rock). Some common uses include insulating empty lofts, stud walls, and under suspended timber floors. Other materials such as sheep's wool are also available.	0.034 – 0.044
Loose-fill Material	Loose-fill material, made of cork granules, vermiculite, mineral wool, or cellulose fiber is usually poured between the joists to insulate lofts. It is ideal for loft spaces with awkward corners or obstructions, or if the joists are irregularly spaced.	0.035 – 0.055
Blown Insulation	Blown insulation is made from cellulose fibers or mineral wool. Spray foam insulation is made from Polyurethane (PUR). Blown insulation should only be installed by professionals, who use special equipment to blow the material into a specific, sectioned-off area, to the required depth. The material may remain loose if used for loft insulation, but can also bond to a surface (and itself) for insulating stud walls and other spaces.	0.023 – 0.046
Rigid Insulation Boards	Rigid insulation boards are mostly made from foamed plastic such as polystyrene, polyurethane (PUR), or polyisocyanurate (PIR), which can be used to insulate walls, floors, and ceilings. PUR and PIR board are among the best insulation materials commonly used, and so are useful where space is limited. Rigid board must be cut to size, so fitting is often a skilled job.	0.02 – 0.081

The range of thermal conductivity can be used by auditors and reviewers to check for reasonableness of the project team's claims about insulation properties. It can also be used as a substitute in the rare case when manufacturer data is not available.

Relationship to Other Measures

Selecting this measure will show an increase in the environmental impact in the materials section due to the addition of insulation material (reflected as a negative percent improvement).

However, by increasing the level of insulation the heating and/or cooling loads will be reduced. Increasing the levels of insulation could therefore reduce the cost and environmental impact of the heating and cooling plant, leading to energy savings that compensate for the negative impacts in the materials section while providing thermal comfort.

ENERGY EFFICIENCY MEASURES IN EDGE

Compliance Guidance

Design Stage	Post-Construction Stage
<p>At the design stage, the following must be used to demonstrate compliance:</p> <ul style="list-style-type: none">• Building plans highlighting the area of major floor slab types if more than one type is present; and• Detailed drawing(s) showing the layers of floor slab materials and any U-value specifications; and• Calculation of overall floor U-value using either the calculator provided in the EDGE measure or external calculations; and• Manufacturer’s data sheets for the specified building materials; or• Bill of quantities with the specifications for any floor insulation materials clearly highlighted.	<p>At the post-construction stage, the following must be used to demonstrate compliance:</p> <ul style="list-style-type: none">• Documents from the design stage if not already submitted. Include any updates made to the documents to clearly reflect As-Built conditions; and• Date-stamped photographs of the floor(s) taken during construction at a point when any insulation materials claimed were visible on site; or• Purchase receipts showing the installed products. <p>Existing building projects</p> <ul style="list-style-type: none">• If the documents required above are not available, other evidence of construction details, such as existing building drawings or photographs can be submitted.

ENERGY EFFICIENCY MEASURES IN EDGE

EEM07 – GREEN ROOF

Requirement Summary

To claim this measure, the project must have a roof covered on top with a layer of growing media and vegetation. Artificial turf does not qualify.

Intention

The soil and vegetation insulate and shade a roof, thus reducing heat transfer through the roof. Transpiration from the vegetation also provides a cooling effect. Green roofs also improve stormwater retention, reducing surface water runoff.

Approach/Methodologies

The following factors are evaluated for a green roof:

- Growing Media Depth – This is the thickness of the soil or other growing media.
- Leaf Area Index – The Leaf Area Index (LAI) is a dimensionless character of vegetation canopies and is defined as the total one-sided area of leaf tissue per unit ground surface area. It is thus a measure of the relative surface area of the leaves in a green roof and determines the amount of carbon gain transpiration²⁷. In EDGE, it informs shading and evaporation.

Leaf area can be calculated by laying the leaves to be measured on a 1-cm grid and tracing their outlines. Count the number of square centimeters. Estimate the area of the partial squares. Count a partial square if it is at least half covered by the leaf; do not count partial squares that are less than half covered. Do not include the area of the stem (petiole) in your calculations.

The value of LAI can range from 0 (no plants) to 5 or higher. Typical LAI values for extensive green roofs (substrate/soil thickness less than 15 cm) are around 1-3²⁸. A value of 5 would indicate a healthy intensive green roof. (See next section for definitions of extensive and intensive roofs.)

- % Green Roof Area – Percentage of the roof covered by the green roof.

The EDGE Base Case assumes no green roof. The Improved Case default is 100% coverage by green roof.

²⁷ <https://www.sciencedirect.com/topics/engineering/leaf-area-index>

²⁸ <https://energy-models.com/forum/leaf-area-index-values-roof-vegetation>

ENERGY EFFICIENCY MEASURES IN EDGE

Potential Technologies/Strategies

There are three main types of green roofs²⁹:

1. Extensive Green roofs – Green roofs with 8-15 cm of light-weight growing medium and low-maintenance ground-cover plants. These are ideal for large flat commercial rooftops and apartments.
2. Intensive Green Roofs – Also known as rooftop gardens, these are fully landscaped with 20-30 cm or more of growing medium and require regular maintenance. Plants with invasive root systems should be avoided.
3. Semi-intensive Green Roofs – These are a combination of extensive and intensive green roofs and typically adopted to reap the environmental benefits of a green roof within a reasonable budget.

Relationship to Other Measures

Green roofs improve the U-value and reduce the energy use for space heating and cooling. They can increase the weight of the roof and may require a thicker slab. They may also impact water use if they require irrigation; however, several options are available for 'xeriscape' plantings that do not require to be irrigated.

Compliance Guidance

Design Stage	Post-Construction Stage
<p>At the design stage, the following must be used to demonstrate compliance:</p> <ul style="list-style-type: none">• Building plans highlighting the area of green roof; and• Section drawing(s) showing the layers of roof materials; and• Leaf Area Index of the planned vegetation	<p>At the post-construction stage, the following must be used to demonstrate compliance:</p> <ul style="list-style-type: none">• Documents from the design stage if not already submitted. Include any updates made to the documents to clearly reflect As-Built conditions; and• Date-stamped photographs of the green roof after installation; and• Contractor invoice for As Built details of the installed roof. <p>Existing building projects</p> <ul style="list-style-type: none">• If the documents required above are not available, other evidence of construction details, such as existing building drawings or photographs can be submitted.

²⁹ <https://commons.bcit.ca/greenroof/faq/what-are-the-different-types-of-green-roofs/>

EEM08* – INSULATION OF EXTERIOR WALLS

Requirement Summary

This measure refers to U-value as the indicator of thermal performance. The use of insulation improves the U-value. The measure can be claimed if the U-value of the external walls is lower than the base case U-value. The user must select the measure for 'Insulation of the External Walls' in the Energy tab in all cases except when the measure is not marked with an asterisk, or when the project U-value is better than the baseline and a project chooses not to take credit for it (an auditor must verify this).

The actual U-value of the wall should be entered in the software by selecting the measure for 'Insulation of External Walls' in the Energy tab. For multiple exterior wall types with different U-values, use an area-weighted average. Note that the measure for 'Wall Insulation' should also be selected in the Materials tab, and the actual insulation type and thickness entered.

Intention

Insulation is used to prevent heat transmission from the external environment to the internal space (for warm climates) and from the internal space to the external environment (for cold climates). Insulation aids in the reduction of heat transmission by conduction³⁰, so more insulation implies a lower U-value and better performance. A well-insulated building has lower cooling and/or heating energy requirements.

Please note that many modern insulating materials, such as certain foam-based insulations, as well as air cavities that improve the sustainability and energy efficiency of buildings also spread fire more easily than traditional materials such as concrete and wood. The project team is encouraged to take proper fire safety precautions in the selection of these materials and the associated design details such as fire stops.

Approach/Methodologies

This measure uses U-value, which is defined as the quantity of heat that flows through unit area in unit time, per unit difference in temperature; it is expressed in Watts per square meter Kelvin (W/m^2K). U-value is an indication of how much thermal energy (heat) is transmitted through a material (thermal transmittance). The U-value, which is the performance indicator of this measure, is the reciprocal of the total thermal resistance³¹ ($1/\Sigma R$) of the external walls, which is calculated from the individual thermal resistance of each component/layer of each external wall.

If the default improved case is used (as shown in EDGE as the top insulation material in the dropdown), the design team must demonstrate that the U-value of the external walls does not exceed the U-value assumed by EDGE. This can be obtained by the manufacturer or by the "simple method" calculation, which is explained as

³⁰ Conduction is the process by which thermal energy moves within an object or between connected objects.

³¹ Thermal resistance is a measure of how much heat loss is reduced through a given thickness of a material. Thermal resistance is expressed as the R, which is measured in square meters Kelvin per Watt (m^2K/W).

ENERGY EFFICIENCY MEASURES IN EDGE

follows. If a different U-value for the external walls is used, then it must be calculated with the following formula or in accordance with the “combined method”³² given in ISO 6946.

Simple method of calculating the U-value:

$$U - Value = \frac{1}{R_{si} + R_{so} + R_1 + R_2 + R_3 \text{ etc}}$$

Where: R_{si} = Resistance of air layer on the inner side of the external wall (add constant of air)

R_{so} = Resistance of air layer on the external side of the external wall

$R_1, 2 \text{ etc.}$ = Resistance of each layer material within the external wall

The resistance of a wall material is derived by the following formula: $R = \frac{d}{\lambda}$

Where: d = Thickness of the layer of material (m)

λ = Thermal conductivity³³ in W/m K

As seen in the formula above, the insulating capacity is a direct function of the thickness of the material. Table 16 demonstrates how to achieve a U-value of 0.45W/m² K for a certain thickness. The actual thickness required will depend on many other factors, including the fixing method, wall construction, and the position of the insulation within the material layers.

Table 16: Thickness of insulation required to achieve a U-value of 0.45 W/m² K³⁴

Insulation Type	Thickness (mm)	Thermal Conductivity
	Approximate values to achieve a U-value of 0.45W/m ² K	(W/m K)
Vacuum Insulated Panels	10 - 20mm	0.008
Polyurethane (PU)	40 - 80mm	0.020 - 0.038
Polyisocyanurate (PIR)	40 - 60mm	0.022 - 0.028
Phenolic Foam (PF)	40 - 55mm	0.020 - 0.025

³² Several websites give worked examples for the calculation of the U-value according to the “combined method:”

- Conventions for U-value calculations, Brian Anderson, BRE, 2006. [http://www.bre.co.uk/filelibrary/pdf/rpts/BR_443_\(2006_Edition\).pdf](http://www.bre.co.uk/filelibrary/pdf/rpts/BR_443_(2006_Edition).pdf)
- Worked examples of U-value calculations using the combined method, The Scottish Government, 2009 - <http://www.scotland.gov.uk/Resource/Doc/217736/0088293.pdf>
- Determining U-values for real building elements, CIBSE - <http://www.cibsejournal.com/cpd/2011-06/>

³³ Thermal conductivity is a standardized measure of how easily heat flows through any specific material, independent of material thickness. It is measured in Watts per meter Kelvin (W/m K), and is often expressed as the “K Value” or “λ”.

³⁴ Source: Insulation Materials Chart, Energy Savings Trust, 2004

ENERGY EFFICIENCY MEASURES IN EDGE

Expanded Polystyrene (EPS)	60 - 95mm	0.030 - 0.045
Extruded Polystyrene (XPS)	50 - 80mm	0.025 - 0.037
Wool and Fiber	60 - 130mm	0.030 - 0.061

EDGE provides a built-in calculator for calculating the U-value of a wall with multiple layers of materials next to each other. For more complex assemblies, for example, if the materials are not in continuous layers or metal penetrations punctuate the wall, dedicated U-value calculation software or energy modelling software can also be used.

ENERGY EFFICIENCY MEASURES IN EDGE

Potential Technologies/Strategies

Insulating the external walls is potentially the most cost-effective way to reduce the energy used for heating a building. Therefore, in cold or temperate climates a strong case can be made for maximizing the insulation before designing the heating ventilation and air conditioning equipment. In hot climates insulating the wall can reduce heat gain, but the effect is relatively minor.

Different types of insulation are available, and the appropriate type will depend on the application as well as cost and availability. Insulation types can be grouped into four main categories, as shown in Table 17:

Table 17. Insulation types and typical conductivity range

Insulation Type	Description	Typical Conductivity Range (λ - K Value)
Matting, Blanket, or Quilt Insulation	This type of insulation is sold in rolls of different thicknesses and is typically made from mineral wool (fiber made from glass or rock). Some common uses include insulating empty lofts, stud walls, and under suspended timber floors. Other materials such as sheep's wool are also available.	0.034 – 0.044
Loose-fill Material	Loose-fill material, made of cork granules, vermiculite, mineral wool, or cellulose fiber is usually poured between the joists to insulate lofts. It is ideal for loft spaces with awkward corners or obstructions, or if the joists are irregularly spaced.	0.035 – 0.055
Blown Insulation	Blown insulation is made from cellulose fibers or mineral wool. Spray foam insulation is made from Polyurethane (PUR), and should only be installed by professionals, who use special equipment to blow the material into a specific, sectioned-off area, to the required depth. The material may remain loose if used for loft insulation, but can also bond to a surface (and itself) for insulating stud walls and other spaces.	0.023 – 0.046
Rigid Insulation Boards	Rigid insulation boards are mostly made from foamed plastic such as polystyrene, polyurethane (PUR), or polyisocyanurate (PIR), which can be used to insulate walls, floors, and ceilings. PUR and PIR board are among the best insulation materials commonly used, and so are useful where space is limited. Rigid board must be cut to size, so fitting is often a skilled job.	0.02 – 0.081

Auditors and reviewers can use the range of thermal conductivity to check for reasonableness of the project team's claims about insulation properties. The range can also be applied as a substitute in the rare case when manufacturer data is not available.

ENERGY EFFICIENCY MEASURES IN EDGE

Relationship to Other Measures

Selecting this measure will show an increase in the environmental impact in the materials section due to the addition of insulation material (reflected as a negative percentage impact).

By increasing the level of insulation, the heating and/or cooling loads will be reduced. Increasing the levels of insulation could therefore reduce the cost and environmental impact of the heating and cooling plant.

If this measure is not selected, which assigns the Wall a U-value, a U-value will be assigned to the wall via the selection of the Exterior Wall Material. Changing the wall material will change the heat transfer through the wall which will impact the building's energy use.

Compliance Guidance

To claim this measure, it is necessary to demonstrate that the U-value of the complete external walls specification is better (lower) than the base case.

Design Stage	Post-Construction Stage
<p>At the design stage, the following must be used to demonstrate compliance:</p> <ul style="list-style-type: none">• Building plans highlighting the area of major exterior wall types if more than one type of wall is present; and• Detailed drawing(s) showing the layers of exterior wall materials and any U-value specifications; and• Calculation of overall exterior wall U-value using either the calculator provided in the EDGE measure or external calculations; and• Manufacturer's data sheets for the specified building materials showing the brand and product name and insulating properties of any insulation; or• Bill of quantities with the specifications for any exterior wall insulation materials clearly highlighted.	<p>At the post-construction stage, the following must be used to demonstrate compliance:</p> <ul style="list-style-type: none">• Documents from the design stage if not already submitted. Include any updates made to the documents to clearly reflect As-Built conditions; and• Date-stamped photographs of the exterior wall(s) taken during construction at a point when any insulation materials claimed were visible on site; or• Purchase receipts showing the installed products. <p>Existing building projects</p> <ul style="list-style-type: none">• If the documents required above are not available, other evidence of construction details, such as existing building drawings or photographs can be submitted.

ENERGY EFFICIENCY MEASURES IN EDGE

EEM09* – EFFICIENCY OF GLASS

Requirement Summary

This measure can be claimed if the glass is multi-paned (double or triple), or if Low Emissivity (Low-E) coated glass is used and has a superior thermal performance.

Even if the U-value of the actual glass in the building is worse (higher) than the base case value, the measure must be selected, and the U-value entered when the measure is required (marked with an asterisk). For example, this could happen in countries where double glazing is the norm for office buildings, making the base case values quite good. The same principle is applicable to the Solar Heat Gain Coefficient (SHGC), i.e., if the SHGC is different from the base case assumption, whether better or worse, the measure must be selected and the actual SHGC must be entered.

Intention

The addition of a Low-E coating to glazing reduces the transference of heat from one side to the other by reflecting thermal energy. Low-E coatings are microscopically thin metal or metallic oxide layers that are deposited on a glass surface to help keep heat on the same side of the glass from which it originated. In warm climates the intention is to reduce heat gain, and in cold climates the intention is to reflect interior warmth back indoors.

By selecting double or triple glazing, which has an improved thermal performance as well as a coating (tinted glass or Low-E) the heat transfer is reduced further than with low-E coating alone, and an even lower SHGC can be achieved.

Approach/Methodologies

Double or triple glazing or Low-E coating reduces the Solar Heat Gain Coefficient (SHGC) and thermal conductivity (U-Value) of the glazing. A third value is the Visible Transmittance (VT) which can be impacted by the coatings.

These concepts are explained as follows:

SHGC is expressed as a number between 0 and 1 and indicates the fraction of incident solar radiation admitted through a window, both directly transmitted and absorbed and subsequently released inward³⁵. A lower solar heat gain coefficient indicates lesser solar heat transmitted.

All multi-pane and Low-E glass will have a reduced U-Value compared to a plain sheet of glass; however, the product's solar heat gain performance determines its appropriateness for a particular climate. For warm

³⁵ <http://www.efficientwindows.org/shgc.php> (accessed 3/28/18)

ENERGY EFFICIENCY MEASURES IN EDGE

climates, glass with a low SHGC helps reduce unwanted solar gains. But in cold climates, glazing that has minimal impact on SHGC is more desirable.

In both warm and cold climates, the lower **U-Value** of glazing is an advantage. Manufacturers often provide separate U-Values for summer and winter (or the heating and cooling seasons). A simple approach is to calculate the average of these two values. If an alternative approach is used to calculate the seasonal average, then this must be justified. For example, an acceptable justification is if the building is in an area that lacks a heating season. In cases where multiple glass types are used, a weighted average must be applied, which can be calculated using the built-in calculator in EDGE accessed from the Options menu.

Note that EDGE uses the U-value and SHGC of the glass, and the frame is calculated separately. Window U-value is the area-weighted average of the U-value of the glass and frame.

Simple method of calculating the U-value and SHGC of a window:

$$\text{Window } U - \text{value} = \frac{U_g \times A_g + U_f \times A_f}{A_g + A_f}$$

Where:

- U_g = U-value of glass
- A_g = Area of glass in elevation view
- U_f = U-value of frame
- A_f = Area of frame in elevation view

Similarly, the SHGC of the Window is the area-weighted average of the SHGC of the glass and frame. For cases where the exact value may not be known, typical values can be referenced from the ASHRAE Handbook of Fundamentals.

Visible transmittance (VT) also known as Visible light transmission (VLT) indicates the fraction of incident visible light that passes through the glass. The higher the number, the greater the amount of light that is passing through the glass. It can be expressed as 0 to 1 or as a percentage. A glass type with VT 0.5 lets in 50% of the visible light. A glass type with VT 0.75 lets in 75% of the visible light. Coatings reduce the VT of high-performance glass as compared to clear glass. Therefore, VT is a useful metric to compare two glass types that may have similar U-values and SHGC. Higher VT is desirable in most areas where daylighting is desired.

ENERGY EFFICIENCY MEASURES IN EDGE

Potential Technologies/Strategies

Low-E coating is applied to different sides of the glazing depending on the climate. In single-pane windows, the coating may be applied inside or outside depending on the coating. For double pane windows, the coating is usually applied on the outer surface of the inner pane in cold climates to allow useful solar radiation to pass through to passively heat the interior, and to reduce the ability for infrared radiation to reflect out. In warm climates, the coating is usually applied on the inner surface of the outer pane, as this helps to reflect the solar radiation back outside before it enters the air cavity.

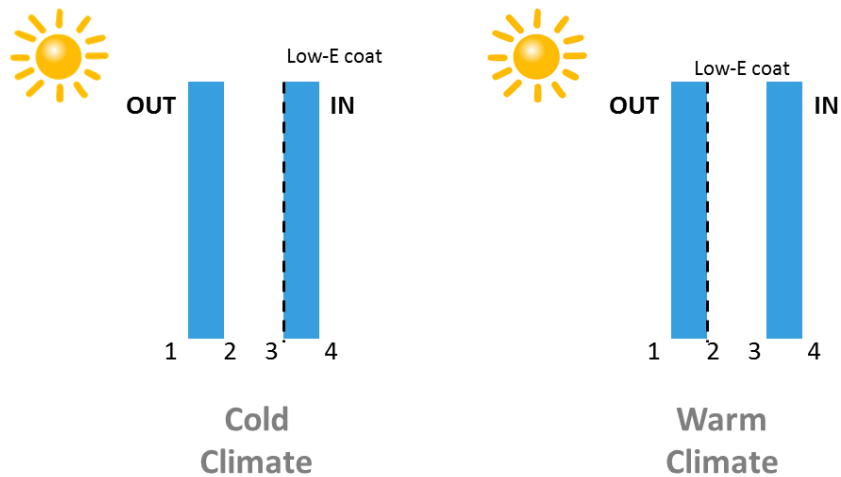

Figure 17. Recommended position of the low-e coating for double-pane glass

Two types of Low-E coating are available: hard coat and soft coat. Only hard coat (pyrolytic coating) should be used in single-glazed units as it is more durable than soft coat (sputter coating).

- **Hard Coat Low-E:** Hard coat Low-E, or pyrolytic coating, is a coating applied at high temperatures and is sprayed onto the glass surface during the float glass process. The coating process, known as Chemical Vapor Deposition (CVD), uses a variety of chemicals including silicon, silicon oxides, titanium dioxide, aluminum, tungsten, and many others. The vapor is directed at the glass surface and forms a covalent bond with the glass, so the result is hard wearing.
- **Soft Coat Low-E:** Soft coat Low-E, or sputter coating, is applied in multiple layers of optically transparent silver sandwiched between layers of metal oxide in a vacuum chamber. This process provides the highest level of performance and a nearly invisible coating. However, it is highly susceptible to damage from handling (recommended in double glazing units).

ENERGY EFFICIENCY MEASURES IN EDGE

Table 18 shows a range of U-Values and SHGC values for different types of single glazing, and provides guidance for the selection of glazing. However, this data varies from manufacturer to manufacturer; for certification purposes actual values from the manufacturer must be provided. In addition, many manufacturers' literature indicates the Solar Coefficient (SC) instead of the SHGC, with the conversion equation as follows:

$$SHGC = SC \times 0.87$$

Table 18: Approximate SHGC and U-values for different glazing types

Glass Configuration					Approximate SHGC	Approximate U-value [W/m ² K]
Type of Glass	Performance	Thickness (mm)	Color	Coated		
Single glass	Medium solar control	6 mm (Double)	Gold	Hard (Pyrolytic)	0.45	2.69-2.82
	Good solar control	6 mm	Blue / Green	Soft (sputtered)	0.36 – 0.45	3.01 -3.83
				Hard (Pyrolytic)	0.33 - 0.41	2.84 – 3.68
		8 mm	Blue / Green	Soft (sputtered)	0.32	2.99 – 3.79
				Hard (Pyrolytic)	0.30 - 0.37	2.82 – 3.65
		6 mm	Bronze	Soft (sputtered)	0.45	3.01 -3.83
		6 mm	Gray	Soft (sputtered)	0.41	3.01 -3.83
		8 mm	Gray	Hard (Pyrolytic)	0.36	2.84 – 3.68
				Hard (Pyrolytic)	0.32	2.82 – 3.65
				Hard (Pyrolytic)	0.52	2.83 -3.68
8 mm	Clear	Hard (Pyrolytic)	0.51	2.81 -3.65		

Relationship to Other Measures

High performance glass either reduces the heat load by reducing the heat loss through the glazing, or reduces the cooling load by reducing the solar heat gain. As with other measures which relate to the improvement of the building fabric, addressing and optimizing performance is cheaper to do before sizing/selecting heating, ventilation, and the air-conditioning plant.

Care must be taken in cold climates, because as the U-Value is reduced, the SHGC is reduced even further for many glass types. Low SHGC reduces heat gain from the sun and increases heating requirements during the sunlit hours. In those cases, a window with a double or triple layer glass resulting in low U-value but with a higher solar heat gain coefficient (SHGC) may be the right selection.

ENERGY EFFICIENCY MEASURES IN EDGE

Compliance Guidance

When the project has multiple types of glazing with multiple U-values and SHGC, a weighted average U-value and SHGC must be entered in the user entry fields.

The following information must be provided to show compliance at the design and post-construction stages:

Design Stage	Post-Construction Stage
<p>At the design stage, the following must be used to demonstrate compliance:</p> <ul style="list-style-type: none">Manufacturer's data sheets showing the seasonal average U-value for the window (including glass and frame), the solar heat gain coefficient (SHGC) of the glass and frame types, and VT; andA list of different types of windows included in the design (window schedule).	<p>At the post-construction stage, the following must be used to demonstrate compliance:</p> <ul style="list-style-type: none">Documents from the design stage if not already submitted. Include any updates made to the documents to clearly reflect As-Built conditions; andDate-stamped photographs of the glazing units installed; orPurchase receipts showing the brand and product installed. <p>Existing building projects</p> <ul style="list-style-type: none">If the documents required above are not available, other evidence of construction details, such as existing building drawings or photographs can be submitted.

EEM10 – AIR INFILTRATION OF ENVELOPE

Requirement Summary

This measure can be claimed if the air infiltration of the building envelope is reduced below the baseline. This reduction can be demonstrated either through the results of a blower door test or through improved construction details.

Intention

By reducing air infiltration, the load on the air conditioning system can be reduced significantly.

Approach/Methodologies

Air infiltration in a building can be represented in an energy model by air changes per hour (ACH) of the entire air volume in a building. It can be represented by average leakage through the envelope measured in volume per unit time per unit surface area. EDGE uses the latter, expressed in Liters/second-square meter (L/s-m²). This air leakage rate puts a load on the air conditioning system. It can increase cooling loads during hot weather, but it has a larger impact on heating loads in cold climates where the temperature difference between the inside and outside can be very high.

Potential Technologies/Strategies

Bulk air leakage can occur through poor joints and gaps and when windows and doors are opened. In addition, the entire surfaces of walls and roofs can allow air exchange at a slow and steady rate because most building materials are pervious to air and moisture molecules. Air molecules are smaller than water molecules, so materials that resist moisture (vapor barriers) may still allow air exchange. Effective air barriers require higher levels of impermeability (lower 'perm' rating – a measure of permeability) compared to vapor barriers.

Strategies to reduce air leakage include:

- a. Continuous air barrier on all exterior opaque surfaces (walls, roof, floor if raised). This can be an airtight wrap made of special paper with very low permeability to air, or a rubberized paint with similar properties. Insulation boards with special coatings that serve the same purpose are also available and reduce construction time in buildings that are installing exterior insulation anyway.
- b. Sealed window and door frames and joinery details. The gap between a window or door frame and the wall can be a source of bulk leakage.
- c. Sealed envelope penetrations (pipes, ducts, cables)
- d. Sealed and taped envelope junctions (wall corners, wall, and roof joints)
- e. Self-closing external doors
- f. Entrance vestibule to limit the air exchange when opening doors
- g. Air curtains on external doors which mechanically push air down creating a barrier between the inside and the outside air to limit the air exchange when opening doors
- h. Door sweeps that cover any gap between the door and the floor

ENERGY EFFICIENCY MEASURES IN EDGE

Relationship to Other Measures

A reduction in air leakage will reduce cooling and heating energy use.

Compliance Guidance

Design Stage	Post-Construction Stage
<p>At the design stage, the following must be used to demonstrate compliance:</p> <ul style="list-style-type: none"> • Drawings and/or specifications for airtightness to be confirmed during construction using a blower door test; or • For each item below that is present in the building, show schematics/detailed drawings and manufacturer’s data sheets showing air flow ratings for all materials intended for use to achieve the airtightness: <ol style="list-style-type: none"> a. Continuous air barrier on all exterior opaque surfaces (walls, roof, floor if raised) with airtightness ratings b. Sealed window and door frames and joinery details c. Sealed envelope penetrations (pipes, ducts, cables) d. Sealed and taped envelope junctions (wall corners, wall and roof joints) e. Self-closing external doors f. Entrance vestibule g. Air Curtains on external doors h. Door Sweeps 	<p>At the post-construction stage, the following must be used to demonstrate compliance:</p> <ul style="list-style-type: none"> • Documents from the design stage if not already submitted. Include any updates made to the documents to clearly reflect As-Built conditions; and • Provide whole building blower door test reports by accredited testing agencies showing air leakage rates in as-built conditions; or • For each item below that is present in the building, provide date-stamped photographs taken during construction showing the make and model matching the specifications or data sheets as applicable: <ol style="list-style-type: none"> a. Continuous air barrier on all exterior opaque surfaces b. Sealed window and door frames and joinery details c. Sealed envelope penetrations (pipes, ducts, cables) d. Sealed and taped envelope junctions (wall corners, wall and roof joints) e. Self-closing external doors f. Entrance vestibule g. Air Curtains on external doors h. Door Sweeps or • Purchase receipts for each applicable item showing the make and model matching the specifications or data sheets as applicable. <p>Existing building projects</p> <ul style="list-style-type: none"> • If some of the documents required above are not available, other evidence of construction details, such as existing building drawings or photographs can be submitted.

ENERGY EFFICIENCY MEASURES IN EDGE

EEM11 – NATURAL VENTILATION

Requirement Summary

This measure can be claimed when two conditions are met.

1. Room geometry conditions must be met. These include the 'room depth to ceiling height ratio' and the 'minimum area of opening.'
2. If the rooms are air-conditioned, the air-conditioning system in the rooms must be provided with an auto-shut off control that switches the air-conditioning off while the room is being naturally ventilated.

The methodology for the calculation is explained in the Potential Technologies and Strategies section, which also shows the minimum required ventilation conditions and an example of auto-shut off controls.

Table 19 shows the spaces that must be naturally ventilated for each building type to claim the natural ventilation measure. Each row in the table represents a separate measure in the software.

Table 19: Areas to be Naturally Ventilated, by Building Type

Building Type	Spaces that must have natural ventilation
Homes	Bedrooms, Living Room, Kitchen
Hospitality	Corridors
	Guest Rooms (with auto controls)
Retail	Corridors, Atrium, and Common Areas
Offices	Offices, Corridors and Lobby
Hospitals	Corridors
	Lobby, Waiting, and Consultation Areas
	Patient Rooms
Education	Corridors
	Classrooms

For multiple rooms of one type, the condition must be met by 90% of the rooms of that type in the building e.g. rooms of a hotel.

ENERGY EFFICIENCY MEASURES IN EDGE

Intention

A well-designed natural ventilation strategy can improve occupant comfort by providing both access to fresh air as well as reducing the temperature. This results in a reduction of the cooling load, which lowers initial capital and maintenance costs.

Approach/Methodologies

EDGE uses two types of Natural Ventilation methods to calculate the potential effectiveness of the ventilation, and follows the CIBSE Applications Manual AM10 for the natural ventilation calculation methodology.

1. Single-sided
Single vent, Wind driven
2. Cross-flow Ventilation
Wind driven

The default opening of the façade is considered as 40% for the improved case. Both the 'Opening in Façade' and the 'Ventilation Type' must be entered into the built-in calculator in EDGE accessed from the options menu. Each relevant space type for a project must be entered on a separate row in the calculator to ensure adequate natural ventilation for all the required spaces in the building. Savings will be calculated accordingly.

The EDGE base case assumes that ventilation is delivered using mechanical means, while the improved case assumes that natural ventilation provides cooling during the hours when the temperature outside is suitable. If the building has mechanical cooling, the savings are reflected in the main Energy chart in the Cooling and associated energy uses. If the building does not have mechanical cooling, the cooling load is still calculated and is shown as "virtual" energy on the charts.

EDGE uses cross-flow ventilation, where fresh air is drawn from outside into the occupied space and the exhaust air is delivered at a different location, as explained in

ENERGY EFFICIENCY MEASURES IN EDGE

Table 20. This type of ventilation is used for the improved case as it is most effective if the external air temperature is neither too hot nor too cold (temperate climates). As EDGE considers the external temperature, the software can test the ventilation’s potential effectiveness. If EDGE predicts significant savings, then a suitable natural ventilation strategy should be considered.

Cooling load in EDGE is reduced through a combination of natural ventilation and other passive measures including improved insulation, reduced window-to-wall ratio, reduced SHGC, improved solar shading, and specifying ceiling fans. Reducing the cooling load will result in improved performance even when no mechanical cooling is specified, and these savings are reflected in “virtual energy”.

Potential Technologies/Strategies

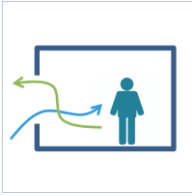
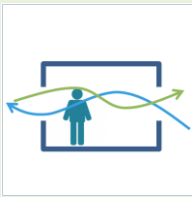
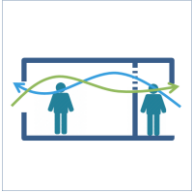
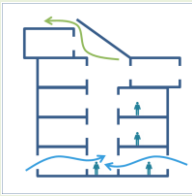

Figure 18. Auto shut-off control for air-conditioning based on natural ventilation

Two basic approaches are most often implemented in the design of cross ventilation: single-sided and two-sided. Two-sided ventilation is used to ventilate single spaces (which have openings on both windward and leeward sides) and double-banked rooms that rely on openings in corridors between rooms. Single-sided ventilation is used where two-sided ventilation is not possible, but the room depth that can be ventilated in this way is much lower.

ENERGY EFFICIENCY MEASURES IN EDGE

Table 20: Types of natural ventilation

Type	Image	Description
Single-sided Ventilation		Single-sided ventilation relies on the pressure differences between different openings within a single space. It is more predictable and effective than if there is only a single opening, and can therefore be used for spaces with greater depth. For spaces that only have a single opening the ventilation is driven by turbulence. This turbulence creates a pumping action on the single opening, causing small inflows and outflows. As this is a less predictable method, the room depth for single opening, single-sided ventilation is reduced.
Cross-ventilation - Single Spaces		Cross ventilation of single spaces is the simplest and most effective approach. Cross-ventilation is driven by pressure differences between the windward and leeward sides of the space.
Cross-ventilation - Double-Banked Spaces		Cross-ventilation with banked rooms can be achieved by creating openings in the corridor partition. It is only acceptable where a room has ownership of both windward and leeward sides of the building, as the ventilation of the leeward space relies on the occupant of the windward space. The openings also provide a route for noise to travel between spaces. One potential solution is to provide a channel which bypasses the windward space, allowing the occupant of the leeward space complete control of air flow.
Stack Ventilation		Stack ventilation takes advantage of the temperature stratification and associated pressure differentials of the air. Warm air becomes less dense and rises and the cooler air replaces the air that has risen. This type of ventilation requires atriums or height differences.

The key factors in deciding the ventilation strategy are room size (depth, width and height), and the number and location of openings. To achieve acceptable natural ventilation flow, the following methodology must be considered: i) maximum ratio of floor depth to ceiling height, and ii) the heat gains to be dissipated, which determine the total area of the opening. The latter is simplified by only providing the % of floor area as the openable area.

The depth of space that can be ventilated using a cross-flow ventilation strategy is dependent on the floor to ceiling height and the number and location of the openings. The rules of thumb below can be used to assess compliance.

ENERGY EFFICIENCY MEASURES IN EDGE

Room Depth to Ceiling Height Ratio

EDGE’s methodology for natural ventilation requires that the maximum ratio of the room depth versus ceiling height must be calculated first. See Table 21 for the maximum ratios for different room configurations.

Table 21: Depth of floor to ceiling height ratios for different room configurations

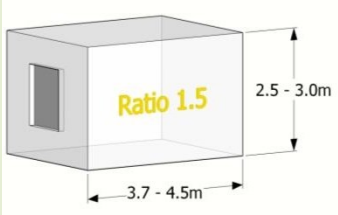
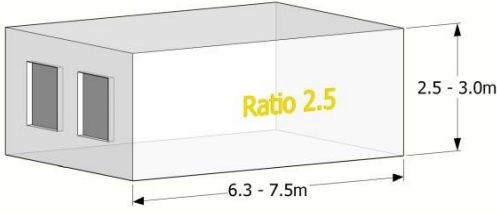
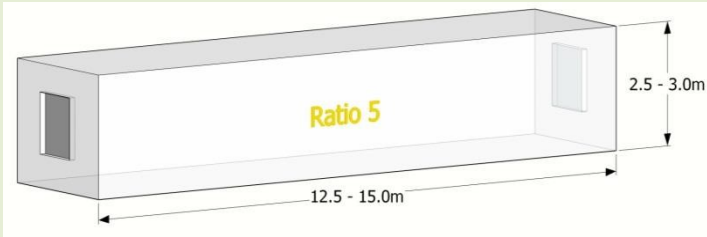
Room/Opening Configuration	Image/Example	Maximum Depth of Floor to Ceiling Height Ratio
<p>Single-sided, single opening</p>		<p>1.5</p>
<p>Single-sided, multiple openings</p>		<p>2.5</p>
<p>Cross ventilation</p>		<p>5.0</p>

ENERGY EFFICIENCY MEASURES IN EDGE

Minimum Area of Opening

The minimum area of opening required depends on the expected heat gains in a space. Table 22 indicates the percentage of the opening area required in each space type to dissipate those heat gains from the space. The built-in calculator in the EDGE App incorporates these percentages automatically. The minimum required area of the opening is calculated by multiplying the total area of the room by the required percentage.

Table 22: Minimum area of opening as a proportion of floor area for different heat gain ranges.

Building Type	Space Type (Heat Gain)	Minimum Area of Opening Required as a Percentage of Floor Area
Homes	Bedrooms (15-30 W/m ²)	20%
	Living Room (15-30 W/m ²)	20%
	Kitchen (>30 W/m ²)	25%
Hospitality	Corridors (<15 W/m ²)	10%
	Guest Rooms (15-30 W/m ²)	20%
Retail	Corridors, Atrium & Common Areas (<15 W/m ²)	10%
Offices	Offices (15-30 W/m ²)	20%
	Corridors and Lobby (<15 W/m ²)	10%
Hospitals	Corridors (<15 W/m ²)	10%
	Lobby, Waiting and Consultation Areas (15-30 W/m ²)	20%
	Patient Rooms (15-30 W/m ²)	20%
Education	Corridors (<15 W/m ²)	10%
	Classrooms (15-30 W/m ²)	20%

Example:

Q: A corridor with 20sqm floor area and ceiling height of 3m has 2 windows for cross ventilation. What are the design criteria to ensure compliance with natural ventilation requirements?

A: The ratio of the depth of the floor to the ceiling height should be less than 5. The ceiling height is 3m, therefore, the maximum depth of the corridor can be 15m. For example, the corridor plan can be 2m x 10m where 10m is the depth.

10% of the floor area should be openable which is 2m², making each window opening area at least 1m².

ENERGY EFFICIENCY MEASURES IN EDGE

Q: A classroom with 16sqm floor area and a ceiling height of 3m has a single window for ventilation. What are the design criteria to ensure compliance with natural ventilation requirements?

A: The ratio of the depth of the floor to the ceiling height should be less than 1.5. The ceiling height is 3m, therefore, the maximum depth of the room can be 4.5. For example, the room plan can be 4m x 4m where the depth is 4m.

20% of floor area should be openable, which is 3.2m². This can be provided by a French door that is 2m high and 1.6m wide.

Relationship to Other Measures

Since employing natural ventilation can significantly reduce the cooling load, the impact of more efficient cooling systems is sometimes reduced to an insignificant level. As with all passive design solutions, natural ventilation should therefore be considered before the detailed design of any HVAC equipment.

Compliance Guidance

If this measure is claimed, then the design team will need to demonstrate compliance with the depth of floor-to-ceiling height ratio and minimum area of opening for all spaces as explained in the Requirement Summary section above.

Design Stage	Post-Construction Stage
<p>At the design stage, the following must be used to demonstrate compliance:</p> <ul style="list-style-type: none">• Typical floor plans for every floor showing the layouts of the naturally ventilated spaces and the location of openings; and• Typical sections showing the floor-to-ceiling height for every floor; and• Calculations within or outside the EDGE App showing that the minimum natural ventilation requirements have been met.	<p>At the post-construction stage, the following must be used to demonstrate compliance:</p> <ul style="list-style-type: none">• Documents from the design stage if not already submitted. Include any updates made to the documents to clearly reflect As-Built conditions; and• Date-stamped photographs showing that the plan layouts and location of openings as specified at the design stage have been constructed. <p>Existing building projects</p> <ul style="list-style-type: none">• If some of the documents required above are not available, other evidence of construction details, such as existing building drawings or photographs can be submitted.

EEM12 – CEILING FANS

Requirement Summary

Ceiling fans must be installed in all the required rooms for the building type as shown below in Table 23. In countries where ceiling fans are standard, the ceiling fans must be energy-efficient for this measure to be claimed.

Table 23: Minimum Required Spaces to be Provided with Ceiling Fans, by Building Type

Building Type	Spaces that must have ceiling fans installed
Homes	All rooms occupied for longer periods (bedrooms and living rooms)
Offices	Office spaces (open and closed offices)
Education	All Classrooms

Intention

Ceiling fans increase air movement, aiding human comfort by promoting the evaporation of perspiration (evaporative cooling).

Approach/Methodologies

The measure can be claimed if ceiling fans have been installed in all the required rooms for a project in line with the guidance above. The assumption is that the efficiency of the ceiling fans installed is 60W/fan. The EDGE base case assumes that no ceiling fans are specified.

Exception: In countries where ceiling fans are required by code or are common practice, ceiling fans are assumed to be present in the base case also; the power consumption of the base case fans is assumed to be 60W/fan. Projects in these countries can claim the ceiling fan measure by installing more efficient ceiling fans. The improved case ceiling fan in these cases is assumed to have a power consumption of 40W/fan.

Potential Technologies/Strategies

Ceiling fans are normally used to reduce cooling energy requirements by creating greater air movement in rooms. The increased air movement results in occupants feeling comfortable at a relatively higher temperature set point. To have this effect, the fan must be installed with the raised edge of the blade on the leading edge. The movement of the fan pulls the air towards the ceiling. In cooling mode, the effect is on perceived comfort, so if a room is unoccupied the fans should be switched off to avoid the waste of energy.

Ceiling fans can also be used to reduce heating requirements by reducing stratification of the warmer air that tends to rise to the ceiling. In this mode, the raised edge of the blades should be at the trailing edge. The

ENERGY EFFICIENCY MEASURES IN EDGE

movement of the fan pushes the warm air down towards the room. Fans often have a switch to change from cooling to heating mode, which works by reversing the direction of rotation of the fan motor.

To achieve the levels of air movement assumed by EDGE, Table 24 shows the minimum fan requirements for different room sizes. The first number in every case is the minimum required diameter in meters. This is also known as 'total blade span,' which is 2 times the radius as measured from the center of the fan to the tip of the blade. The second number is the optimum number of fans required in different sizes of rooms. For example, a 6m x 6m room would require a minimum of 4 fans with a minimum diameter of 0.9m or 900mm each.

Table 24: Minimum fan size (in meters)/Number of ceiling fans required for different room sizes³⁶.

Room Width	Room Length										
	4m	5m	6m	7m	8m	9m	10m	11m	12m	14m	16m
3m	1.2/1	1.4/1	1.5/1	1050/2	1.2/2	1.4/2	1.4/2	1.4/2	1.2/3	1.4/3	1.4/3
4m	1.2/1	1.4/1	1.2/2	1.2/2	1.2/2	1.4/2	1.4/2	1.5/2	1.2/3	1.4/3	1.5/3
5m	1.4/1	1.4/1	1.4/2	1.4/2	1.4/2	1.4/2	1.4/2	1.5/2	1.4/3	1.4/3	1.5/3
6m	1.2/2	1.4/2	0.9/4	1.05/4	1.2/4	1.4/4	1.4/4	1.5/4	1.2/6	1.4/6	1.5/6
7m	1.2/2	1.4/2	1.05/4	1.05/4	1.2/4	1.4/4	1.4/4	1.5/4	1.2/6	1.4/6	1.5/6
8m	1.2/2	1.4/2	1.2/4	1.2/4	1.2/4	1.4/4	1.4/4	1.5/4	1.2/6	1.4/6	1.5/6
9m	1.4/2	1.4/2	1.4/4	1.4/4	1.4/4	1.4/4	1.4/4	1.5/4	1.4/6	1.4/6	1.5/6
10m	1.4/2	1.4/2	1.4/4	1.4/4	1.4/4	1.4/4	1.4/4	1.5/4	1.4/6	1.4/6	1.5/6
11m	1.5/2	1.5/2	1.5/4	1.5/4	1.5/4	1.5/4	1.5/4	1.5/4	1.5/6	1.5/6	1.5/6
12m	1.2/3	1.4/3	1.2/6	1.2/6	1.2/6	1.4/6	1.4/6	1.5/6	1.4/8	1.4/9	1.4/9
13m	1.4/3	1.4/3	1.2/6	1.2/6	1.2/6	1.4/6	1.4/6	1.5/6	1.4/9	1.4/9	1.5/9
14m	1.4/3	1.4/3	1.4/6	1.4/6	1.4/6	1.4/6	1.4/6	1.5/6	1.4/9	1.4/9	1.5/9

When considering fans larger than those provided in the table, consider the following rule of thumb. A fan that is twice the size will cover an area that is the square of the size factor. For example, a fan of 2m diameter could replace 4 fans of 1m diameter, and a fan of 3m diameter could replace 9 fans of 1m diameter.

However, the best way to determine the number of fans required is to compare the cfm (cubic feet per minute) of air that a fan is rated for. For example, if a standard small fan moves 60 cfm/watt, and the large fan moves 180 cfm per watt, you could replace 3 small fans with the larger fan. If the large fan moves 300 cfm per watt instead, you could replace 5 small fans with the larger fan. Please start with EDGE guidance to determine the number of small fans required, then include this simple calculation in your documentation to show the replacement calculation. Ideally, the cfm of ceiling fans should be sufficient to move the entire volume of the room in one hour. (Note that this is like air changes per hour for ventilation with a subtle difference; a fan moves air, not changes it.)

³⁶ Source: India National Building Code

ENERGY EFFICIENCY MEASURES IN EDGE

Relationship to Other Measures

The installation of ceiling fans to reduce cooling requirements improves occupant comfort without actively cooling the air. Ceiling fans are therefore only beneficial in spaces that have a demonstrable cooling load.

The installation of ceiling fans to reduce heating requirements does not necessarily decrease the heating load, but can improve occupant comfort by increasing the temperature at floor level and reducing the temperature gradient from floor to ceiling.

Compliance Guidance

To verify compliance, the design team must demonstrate that ceiling fans will be or have been installed.

Design Stage	Post-Construction Stage
<p>At the design stage, the following must be used to demonstrate compliance:</p> <ul style="list-style-type: none">• Mechanical and electrical layout drawings showing the location and number of ceiling fans; and• Manufacturer's data sheets showing the energy consumption and diameter of ceiling fans selected.	<p>At the post-construction stage, the following must be used to demonstrate compliance:</p> <ul style="list-style-type: none">• Documents from the design stage if not already submitted. Include any updates made to the documents to clearly reflect As-Built conditions; and• Date-stamped photographs of the ceiling fan(s) taken during and after installation showing the make and model; or• Purchase receipts for the ceiling fans showing the make and model. <p>Existing building projects</p> <ul style="list-style-type: none">• If some of the documents required above are not available, other evidence of construction details, such as existing building drawings or photographs can be submitted.

EEM13* – COOLING SYSTEM EFFICIENCY

Requirement Summary

If the project includes a cooling system, the actual COP of a system must be entered into the software (even if the COP is lower than Base Case). Savings can be achieved if the air conditioning system provides a Coefficient of Performance (COP) greater than the Base Case.

Intention

In many cases, a cooling system will not be fitted as part of the original build, which increases the risk that future occupants will deal with any insufficient cooling later by installing air-conditioning units that may be inefficient and are poorly sized and installed. By carefully designing the installation of an efficient cooling system into the project, the energy needed to deliver the required cooling can be reduced in the longer term.

Approach/Methodologies

EDGE uses the Coefficient of Performance (COP) to measure the efficiency of air conditioning systems. The COP is the total output of cooling energy per electricity input. The COP for cooling is defined as the ratio of the rate of heating energy removal to the rate of electrical energy input, in consistent units, for a complete air conditioning system or some specific portion of that system under designated operating conditions. The formula to calculate COP is explained below. For consistency the ARI conditions should be used for comparison of COP values.

$$\text{COP} = \frac{Q_{out}}{W_{in}}$$

Where:

Q_{out} = heating energy removal (kW)

W_{in} = electrical energy input (kW)

To claim this measure, the design team must demonstrate that the equipment achieves a COP greater than the base case COP value. For large buildings, more than one system may be installed. If these air conditioning systems have different COPs, the weighted average COP should be calculated.

In some cases, the cooling system could be centralized, serving a combination of buildings/dwellings within the development. The central cooling plant may be within the EDGE project boundary and controlled by the EDGE client, in which case the technical specifications must be submitted. However, when the plant for the cooling system is out of EDGE project boundary or not controlled by the EDGE client, then a contract with, or letter from the management company in charge of the plant must be provided, stating the efficiency of the system, as part of the documentation for the post-construction stage.

If air conditioning is not specified, any cooling load will be displayed as “virtual energy.”

ENERGY EFFICIENCY MEASURES IN EDGE

Potential Technologies/Strategies

Simple air-conditioners fitted in windows and through-the wall unitary air-conditioners are the most common type of air-conditioners used in individual residential units. Apartment buildings may use packaged air-conditioners located on roof tops with ducted air flow. However, these are the least efficient types of systems. Various air-conditioning systems are available that achieve higher cooling efficiency, including split air-conditioners, multi-split air conditioners, VRF systems and chillers.

Split air-conditioners are direct expansion (DX) mechanical refrigeration systems with a single condenser unit outside serving a single fan coil unit (evaporator) inside the building, with refrigerant carried between the two in narrow tubes through the wall. These do not require ducts, and are more efficient than ducted systems. But they can only serve fan coil units located at a limited distance from the external condenser unit.

Multi-split air conditioners are like split systems, except that a single large condenser unit is connected to several fan coil units with individual tubes. The added advantage is the fewer number of outside units. But these systems can only serve spaces that are at similar temperature conditions.

Variable Refrigerant Flow (VRF) systems have one condensing unit with multiple indoor units, each of which can be individually controlled. These systems use refrigerant as the medium for heat transfer. The system runs by modulating the amount of refrigerant that is sent to each evaporator, running only at the rate needed to deliver the cooling required by each internal unit. They systems are a step up from multi-split systems because they can serve zones with different thermal needs, including zones that may be in heating mode while other zones are in cooling mode. VRF systems accomplish this through compressors that can modulate their speed and the refrigerant flow. The refrigerant is distributed through a piping network to multiple indoor fan-coil units, each capable of individual zone temperature control through a common communications network. The system runs only at the rate needed to deliver the temperature change required by each internal unit. To realize savings from a VRF system, the spaces must be zoned separately with their own individual thermostats.

The three basic types of VRF systems include: cooling only, VRF heat pump that provides both heating and cooling but not simultaneously, and VRF with heat recovery that provides heating and cooling simultaneously.

VRF systems may be a particularly good option for buildings with multiple zones or wide variance in heating/cooling loads across many different internal zones. As these systems provide individual control and are the most versatile of the multi-split systems, VRF systems may be the best for buildings such as homes, offices, retail buildings, education, healthcare buildings, or hotels and resorts.

The outdoor units can be fitted to as many as 48 internal units. Due to the way the internal units are connected to the external unit, a breakdown of one internal unit will not compromise the rest of the system. The speed of the outdoor compressors can change to operate in a range of 6% to 100% capacity. Capacities have typically ranged from 5.3 to 223 kW for outdoor units and from 1.5 to 35 kW for indoor units, but new products are continually being introduced. Multiple outdoor units can be used if an even greater range of capacity is required. Note that the same measure applies to a Variable Refrigerant Volume (VRV) cooling system, which is a patented name for a type of VRF system.

Chillers. Chillers deliver cooling through chilled water which has much higher heat capacity than air, allowing heat to be transferred more efficiently. Chilled water is circulated to provide comfort cooling throughout a building. The system has four components: i) Compressor, ii) Condenser, iii) Thermal expansion valve, and iv) Evaporator. The compressor compresses the refrigerant and pumps it through the air conditioning system at a designed flow rate and pressure. The compressor technology is a way to distinguish the type of air-cooled

ENERGY EFFICIENCY MEASURES IN EDGE

chillers: Reciprocating chillers, rotary screw chillers, or scroll chillers. Selection must be made based on many factors including the size of the system; for example, reciprocating compressors are typically 3–510 refrigeration tons. The cycle begins in the evaporator where a liquid refrigerant flows over the evaporator tube bundle and evaporates, absorbing heat from the water circulating through the bundle. The refrigerant vapor is drawn out of the evaporator by the compressor. The compressor compresses the refrigerant raising its pressure and temperature, and pumps the refrigerant vapor to the condenser. The refrigerant condenses in the condenser tubes, giving up its heat to the air or water that is cooling the condenser. The high-pressure, liquid refrigerant from the condenser then passes through the expansion device that reduces the refrigerant pressure and temperature as it enters the evaporator. The cold refrigerant again flows over the water coils absorbing more heat and completing the cycle.

Air-cooled chillers use air to cool the condenser and are suitable for climates where water supply is scarce or high humidity reduces the efficiency of the cooling towers. **Water-cooled chillers** are like air cooled chillers except that water is used to provide the condenser cooling. Air-cooled chillers cost significantly less per ton than water-cooled systems primarily because they require fewer components to build and operate and require less support equipment and plumbing. Installation of an air-cooled chiller is faster and easier than that of a water-cooled chiller. However, the efficiency of water-cooled chillers is typically higher because of the higher heat capacity of water compared to air. A water-cooled system is the best option when reducing operating costs is of paramount concern and the project can invest in a system with a longer payback period. Water cooling does involve a higher initial investment since both a chiller and a circulating tower system are required, which in turn require additional pumps, piping and tanks. Also, water cooling systems consume considerable amounts of water due to evaporation, purging and bleeding.

Absorption Chiller. An absorption chiller is a type of air-cooling device that absorbs waste heat instead of electrical energy to provide cooling. An absorption chiller has a low COP. However, it can reduce operating costs because it is powered by waste heat. An absorption chiller is a much more cost-effective alternative to a traditional cooling system due to the use of waste heat as fuel and lower maintenance.

Waste heat is the result (byproduct) of building processes or industrial processes that is not being put to practical use. This waste heat is captured to generate cooling as an emission-free substitute for costly purchased fuels or electricity. It is thus a no-cost fuel source which can improve the overall energy efficiency in a facility.

Absorption chillers are more cost-effective in large-sized buildings which are owned and operated by the same manager.

This measure can be claimed if a power generator fueled by Diesel or Natural Gas provides power to the building, and a recovery technology is installed to capture the waste heat from the generator for the cooling cycle. Additionally, the absorption chiller system must achieve a Coefficient of Performance (COP) greater than 0.7 under ARI conditions. By providing a mechanical refrigeration system that uses the waste heat generated in other processes such as electricity generation or industrial processes to run an absorption chiller, the energy needed to deliver the required cooling and/or heating can be reduced significantly. To claim this measure, the design team must demonstrate that the absorption chiller(s) achieve an efficiency greater than 70% (COP >0.7). Although the equipment efficiency is not high, it uses waste heat to power the chiller, thus achieving a higher whole-system efficiency. If this measure is selected, the assumptions in the Design tab must be verified. The user must select the appropriate fuel under 'Generator', and input the appropriate value for '% of Electricity Generation Using [Fuel].'

Ground source heat pumps (GSHPs), sometimes referred to as geothermal heat pumps (GHPs), are used to heat and cool buildings by absorbing naturally existing heat from the earth. A GSHP/GHP takes advantage of

ENERGY EFFICIENCY MEASURES IN EDGE

the more constant below-ground temperature within the earth (soil or water) compared to the more variable outside air temperature. Below-ground temperature is warmer than the air during the winter and cooler than the air in the summer. A GHP takes advantage of this by exchanging heat with the earth through a ground heat exchanger. A GHP can reach a high COP of 3 to 5.2 on the coldest winter nights, compared to air-source heat pumps that only reach up to a 1.5 to 2.5 COP on cool days. Ground source heat pumps are a clean alternative utilizing renewable and reliable sources of energy³⁷. The base case includes an air conditioning system based on ASHRAE 90.1-2016, which is typically a Packaged Terminal Air Conditioner (PTAC) (a ground source heat pump is not a default base case system). When a ground source heat pump is selected as an energy efficiency measure, the heating and/or cooling energy is reduced depending on the load on the building systems. The energy use by pumps is slightly increased due to the operation of the system.

Four major types of ground source heat pump systems (GHPs) are available. Of these four types, three systems – the horizontal, vertical, and pond systems – are closed loop systems. The fourth major type of GHP is the open loop system. A closed loop system recirculates antifreeze or water through a loop of piping that is either buried in the ground or submerged under water. A heat exchanger transfers heat between the refrigerant in the heat pump and the antifreeze/water solution. An open loop GHP system pumps water from a ground or water source, circulates the water and then discharges it once the heat has been transferred into or out of the water. It draws fresh water instead of recirculating the same water again.

³⁷ Source: <http://energy.gov/energysaver/articles/geothermal-heat-pumps> and www.informedbuilding.com

ENERGY EFFICIENCY MEASURES IN EDGE

Table 25: Types of Ground Source Heat Pumps³⁸.

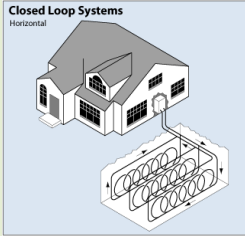
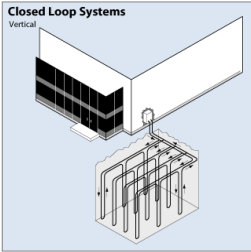
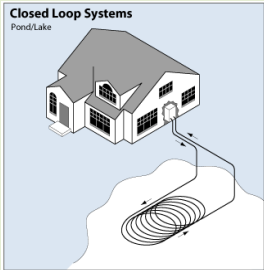
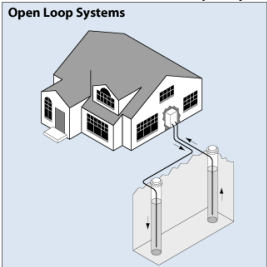
System	Geothermal Heat Pump Type	Process
Closed Loop System	<p>Horizontal³⁹</p>  <p><small>Closed Loop Systems Horizontal</small></p>	<p>A horizontal closed loop is usually the most cost effective for buildings with adequate land space available, in which trenches are easy to dig. This type of installation is composed of pipes that run horizontally in the ground. A slinky method is sometimes used to loop or coil the pipes along the bottom of a wide trench if space is inadequate for a true straight horizontal system. Essentially, coiled loops are more economically and space-efficient.</p>
Closed Loop System	<p>Vertical</p>  <p><small>Closed Loop Systems Vertical</small></p>	<p>A vertical closed loop installation is usually most cost-effective for building sites with limited amount of land space or where existing landscape is to be preserved. This type of installation is composed of pipes that run vertically beneath the ground. Holes are drilled into the ground, in which each hole contains a single loop of pipe that ranges from 30 to 100 meters deep. Vertical pipes are then inserted and connected to a heat pump within the building. This type is more expensive to install due to the drilling, but less material (piping) and land are required.</p>
Closed Loop System	<p>Pond/Lake</p>  <p><small>Closed Loop Systems Pond/Lake</small></p>	<p>A pond or lake closed loop system is used only if a body of water at least 2.5-meter-deep body is in close proximity to the building property. A supply line pipe runs underground from the building and connects to large, coiled pipes that are located deep beneath the water. Due to advantages of water-to-water heat transfer, a pond system is both a highly economical and efficient option for a heat pump.</p>
Open Loop System	<p>Open Geothermal Loop System</p>  <p><small>Open Loop Systems</small></p>	<p>An open geothermal loop system uses a well or pond to pump fresh water into and back out of the geothermal system. The water is used as the heat exchange fluid that circulates within the GHP. An abundant source of fresh clean water and a water runoff area is essential for a successful open loop system.</p>

³⁸ Source: ASHRAE 90.1-2010

³⁹ Source of all images in this table: courtesy of U.S. Department of Energy

ENERGY EFFICIENCY MEASURES IN EDGE

Some minimum efficiencies specified by ASHRAE 90.1-2016 are listed in Table 26. **Error! Reference source not found.** Note that these are for comparative illustration only. The ASHRAE standard contains several COP values for each system type depending on the details of the equipment such as the capacity and technology, and whether the system is optimized for full load or part load operation. This table shows full load values.

Table 26. Examples of current minimum COPs for different types of air conditioning systems⁴⁰

Type of Cooling System (Air Conditioning)	COP
Through the wall, air-cooled, packaged and split ≤ 9 kW	3.51
Air-cooled, split < 19 kW	3.81
Air-cooled, single package < 19kW DX and heat pumps	4.10
Water-cooled, split and single package < 19kW	3.54
PTAC and PTHP, standard size, all capacities In equation, Capacity = 2.1 kW < Capacity < 4.4.kW	4.10 – (0.300 × Capacity/1000)
Variable Refrigerant Flow, air-cooled, cooling mode < 19 kW	3.81
Variable Refrigerant Flow, water source, cooling mode < 19kW	3.52
Variable Refrigerant Flow, groundwater source, cooling mode < 40kW	4.75
Variable Refrigerant Flow, ground source, cooling mode < 40kW	3.93
Air Cooled Chiller < 528 kW	2.985 at Full Load (FL) 4.048 at Part Load (IPLV)
Air Cooled Chiller ≥ 528 kW	2.985 at Full Load (FL) 4.137 at Part Load (IPLV)
Water Cooled Chiller, positive displacement <264 kW (Positive displacement = reciprocating, screw and scroll compressors)	4.694 at Full Load 5.867 at Part Load (IPLV)
Water Cooled Chiller, centrifugal < 528 kW	5.771 at Full Load 6.401 at Part Load (IPLV)

⁴⁰ Source: ASHRAE 90.1-2016, Chapter 6

ENERGY EFFICIENCY MEASURES IN EDGE

Note that if a cooling system other than a chiller is installed in a residential building and achieves the desired COP, then this information can be entered manually into the EDGE software, and evidence provided for certification purposes.

Relationship to Other Measures

Passive measures such as improved walls and windows will reduce the energy use from air-conditioning. The local climate, heat gains and the internal temperatures based on the building design impact the cooling load. A more efficient system will not impact other measures, but several measures will impact the total energy use of the cooling system. A cooling system will have a smaller impact on savings if the building walls and windows have been optimized.

In addition, when a water-cooled chiller is selected as an energy efficiency measure, total water consumption is increased for both the base and the improved case, as the chiller will require water to operate.

Compliance Guidance

To demonstrate compliance, the design team must describe the specified system and provide documentation to support the claims.

Design Stage	Post-Construction Stage
<p>At the design stage, the following must be used to demonstrate compliance:</p> <ul style="list-style-type: none">• Mechanical and electrical layout drawings showing the location of the external and internal components of the space cooling equipment for all floors; and• Equipment Schedule or Manufacturer's data sheets (with the project specific info highlighted & noted) for the space cooling system specifying efficiency information• For systems including more than one type or size of space cooling system, the design team must provide the weighted average efficiency calculations, calculated either within or outside the EDGE App.	<p>At the post-construction stage, the following must be used to demonstrate compliance:</p> <ul style="list-style-type: none">• Documents from the design stage if not already submitted. Include any updates made to the documents to clearly reflect As-Built conditions; and• Date-stamped photographs of the space cooling equipment taken during or after installation showing the make and model; or• Purchase receipts for the space cooling equipment showing the make and model; or• Contract with the management company showing the efficiency of the space cooling system, if the system is under separate management or off-site. <p>Existing building projects</p> <ul style="list-style-type: none">• If some of the documents required above are not available, other evidence of construction details, such as existing building drawings or photographs can be submitted.

EEM14 – VARIABLE SPEED DRIVES

Requirement Summary

This measure can be claimed if the fans and pumps in the cooling system use Variable Speed Drive (VSD) motors, which modulate the motor speed of fans based on actual demand. These are typically variable-frequency drive (VFD) or adjustable-frequency drive motors, although other VSD technologies are available.

Intention

The aim is to encourage the project team to specify VSDs, as energy consumption will be reduced, and therefore the utility costs. VSD fans offer improved system reliability and process control. The lifetime of system components is increased because of lesser use at full capacity leading to lesser wear and tear with less maintenance needed.

Approach/Methodologies

Cooling systems need to operate at the maximum (peak) load only at certain times. For most of the hours in a day, they only need to operate at part loads. VSDs on fans control and regulate the fan speeds depending on the load on the cooling system, as opposed to constant speed fans, thus reducing energy consumption. Variable Speed Drive (VSD) motors use an electronic device to modulate the speed of the fan motors based on actual heating/cooling demand. The power demand of motors is directly proportional to the cube of the motor speed. So, even a 20% reduction in motor speed cuts down power consumption by about half⁴¹.

VSDs are not typically part of the baseline. This measure will show savings only if an air conditioning system is selected, and it is a type that can use VSDs on fans or motors or pumps. The HVAC system must require fans and pumps, such as air or water-cooled chillers, heat pumps or absorption chillers, which must be previously selected. If selected, the assumption for the Improved Case is that all fans or motors or pumps in the system will be provided with VSDs.

To claim this measure, the design team must demonstrate that the fans and pumps in the HVAC system are all VSD.

Potential Technologies/Strategies

VSDs offer a high degree of control and are extremely versatile. They are available both as integrated and standalone devices that can be connected to the fan motor.

In chillers, the air used to cool the water is pulled through the cooling tower by electric motor-driven fans. These fans can be electronically controlled with Variable Speed Drive (VSD) motors. A VSD motor regulates the

⁴¹ <http://www.ecmweb.com/power-quality/basics-variable-frequency-drives>

ENERGY EFFICIENCY MEASURES IN EDGE

speed and the rotational force of the fan by varying the motor input frequency and voltage.

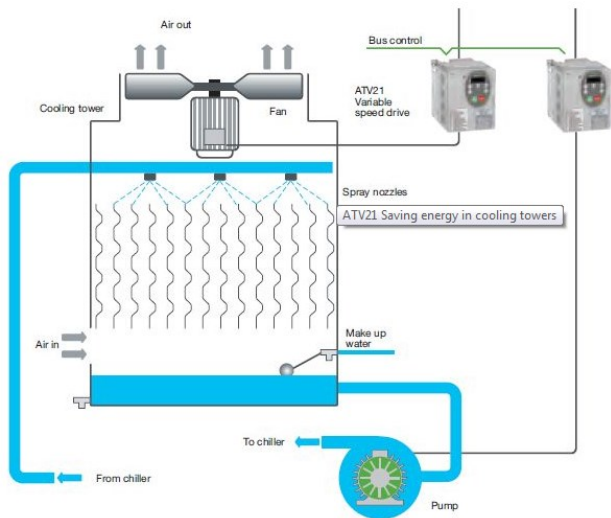

Figure 19. Schematic of cooling tower and VSDs system⁴²

Variable Speed Drive (VSD) pumps use electronics to control the power used by the motor of the pump to adjust the speed of the flow into an HVAC system in response to the demand. VSDs offer a high degree of control and are extremely versatile. They are available as standalone devices that are connected to the motor of the pump except for motors below 15kW, which are embedded or integrated into the motor.

The following are the pros and cons of VSD motors for pumps:

Table 27: Benefits and limitations of VSD motors for pumps

Benefits and Limitations of VSDs for Pumps		
BENEFITS	Improved Process Control:	Provide regulation functions that improve the entire system and protect the other components of the system.
	Improved System Reliability:	Lower chance of failure
	Simplified pipe systems:	Elimination of control valves and by-pass lines
	Improved system lifetime:	Avoidance of soft start and stop, and resulting mechanical overload and peak pressures implied by on-off systems
	Reduced energy costs and maintenance:	Ability to modulate speed and torque at part-loads reduces energy use, and wear and tear
LIMITATIONS	Minimum speed may be required (typically 30%)	Manufacturers may require a minimum speed to avoid problems with overheating and lubrication

⁴² Source: Image courtesy of Joliet Technologies, L.L.C. 2014 and Schneider Electric SE. 2014

ENERGY EFFICIENCY MEASURES IN EDGE

Relationship to Other Measures

When VSDs for the fans of the cooling towers is selected as an energy efficiency measure, the cooling system selected must be Air Conditioning with Water Cooled Chiller to show the savings. Reduced fan energy will also reduce the heat loss from fan motors and, therefore, the load on the cooling energy.

When VSDs for the pumps is selected as an energy efficiency measure, it is required that the HVAC system selected are either air or water-cooled chillers, heat pumps or absorption chillers for savings to show. Reduced pump energy use will also reduce the heat loss from pump motors and, therefore, the load on the cooling energy.

Compliance Guidance

Design Stage	Post-Construction Stage
<p>At the design stage, the following must be used to demonstrate compliance:</p> <ul style="list-style-type: none">• Mechanical and electrical layout drawings highlighting the use of VSDs; and• Manufacturer's data sheets for the mechanical equipment showing VSD specifications.	<p>At the post-construction stage, the following must be used to demonstrate compliance:</p> <ul style="list-style-type: none">• Documents from the design stage if not already submitted. Include any updates made to the documents to clearly reflect As-Built conditions; and• Date-stamped photographs of the equipment with VSD(s) taken during or after installation showing the make and model; or• Purchase receipts for the equipment with VSD(s) showing the make and model. <p>Existing building projects</p> <ul style="list-style-type: none">• If some of the documents required above are not available, other evidence of construction details, such as existing building drawings or photographs can be submitted.

ENERGY EFFICIENCY MEASURES IN EDGE

EEM15 – FRESH AIR PRE-CONDITIONING SYSTEM

Requirement Summary

This measure can be claimed if a device has been installed in the ventilation system to pre-condition the fresh air entering the system to reduce the temperature difference between the outside air and the inside conditioned air.

Intention

Reducing the temperature difference between the outside air entering the building and the inside conditioned air helps to reduce the load on the space conditioning system. This helps to reduce fossil fuel consumption, and lower operating costs. Buildings that use energy for heating or cooling the fresh air supply have the potential to benefit from the application of devices to pre-condition the ventilation air.

Approach/Methodologies

Fresh air can be pre-conditioned using several techniques such as sensible heat recovery (most common), total heat recovery including sensible and latent heat (the device is also known as enthalpy wheel), or indirect evaporative cooling. All these methods use very little energy to pre-condition the air and provide useful heat for space heating and in some cases for space cooling.

When buildings include an HVAC system and the main load of the building is due to space heating, installing heat recovery on the ventilation system reduces energy consumption by preheating the incoming fresh air with the outgoing exhaust air. Alternatively, in cooling mode, the incoming fresh air is cooled with the exhaust air from the air-conditioned space.

To qualify, the design team must demonstrate that the HVAC system has a heat recovery or indirect evaporative cooling device on the fresh air supply system. EDGE uses Temperature Transfer Efficiency (TTE) as the measure of efficiency, which is either quoted by the manufacturer or can be calculated with the following formula:

Temperature Transfer Efficiency (TTE):

$$\mu_t = \frac{T_2 - T_1}{T_3 - T_1}$$

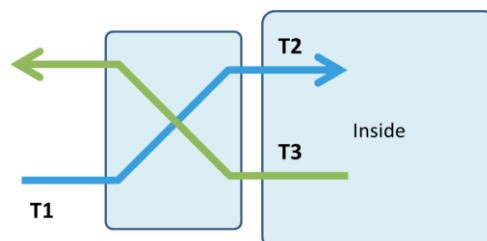

Where: μ_t = Temperature Transfer Efficiency (%)

ENERGY EFFICIENCY MEASURES IN EDGE

T_1 = Outside air temperature **before** heat exchanger (°C)

T_2 = Air temperature **after** heat exchanger (°C)

T_3 = Exhaust air temperature **before** heat exchanger (°C)

No pre-conditioning system is included in the Base Case. The improved case default is a sensible heat recovery device with a Temperature Transfer Efficiency (TTE) of 65%. If the actual TTE value is different than 65%, the rated value must be entered in EDGE. It is assumed that at least 75% of all exhaust air in the building is being passed through the pre-conditioning system.

Potential Technologies/Strategies

1. Heat Recovery – Sensible or Total

Heat recovery aims to collect and reuse the heat arising from a process that would otherwise be lost. This is ideal for colder climates but works for warmer climates also. As air contains moisture, the heat contained within the air can be sensible heat (transfers the temperature only) or latent heat (includes the transfer of water vapor). Some energy recovery devices only transfer sensible heat and some transfer both sensible and latent heat (also called “total heat recovery” or “enthalpy wheel”). The latter are desirable in almost all climates except the very humid.

Sensible Heat Recovery occurs when the temperature of the cooler air stream exchanges heat with the temperature of the warmer air stream. Moisture level is not impacted unless condensation occurs. In some areas of the building where condensation is expected, such as restaurants, spas and pools, this technology is ideal as the materials are anti-corrosive. It is also convenient for light ventilation systems as it offers low pressure drops.

Total Heat Recovery occurs when the moisture is also allowed to transfer along with the heat transfer. This is ideal where the inside air is being artificially humidified and introducing fresh air would drop the moisture levels.

2. Indirect Evaporative Cooling

Indirect evaporative cooling aims to precondition incoming hot air in a warm climate using the principle that evaporation causes cooling. Traditional evaporative cooling can result in uncomfortably high moisture levels. “Indirect” evaporative cooling takes advantage of the cooling effect from evaporation without adding moisture to the incoming air. The device accomplishes this by wetting the exhaust air from the cooled indoor space with water, cooling it further in the process. Incoming air is passed over this moist cooled exhaust air via heat exchangers that transfer the heat but do not transfer the moisture. The exhaust air becomes moist and warm and is ejected out, while dry, cooled air is supplied to the space.

Relationship to Other Measures

Heat recovery from exhaust air reduces the heating load in heating mode and therefore decreases consumption in “Heating Energy.” The same principle applies to the cooling load if the building is predominantly in cooling mode; then the reduction is in “Cooling Energy.” The energy due to “Fans” also decreases slightly as less air is moved. However, in climates where both heating and cooling seasons occur, savings appear in the “heating energy,” but the “cooling energy” increases due to some heat trapped during midseason.

ENERGY EFFICIENCY MEASURES IN EDGE

Compliance Guidance

Design Stage	Post-Construction Stage
<p>At the design stage, the following must be used to demonstrate compliance:</p> <ul style="list-style-type: none">• Mechanical and electrical drawings showing the location of the pre-conditioning system, such as a heat recovery wheel, and indicating the percentage (%) of total air passing through the system; and• Manufacturer’s data sheets for the device specifying the Temperature Transfer Efficiency (TTE); or• A calculation to demonstrate efficiency in case the manufacturer’s data does not specify the TTE.	<p>At the post-construction stage, the following must be used to demonstrate compliance:</p> <ul style="list-style-type: none">• Documents from the design stage if not already submitted. Include any updates made to the documents to clearly reflect As-Built conditions; and• Date-stamped photographs of the installed device showing the make and model; or• Purchase receipts for the device showing the make and model; <p>Existing building projects</p> <ul style="list-style-type: none">• If some of the documents required above are not available, other evidence of construction details, such as existing building drawings or photographs can be submitted.

EEM16* – SPACE HEATING SYSTEM EFFICIENCY

Requirement Summary

This measure can be claimed if the space heating system has an efficiency greater than the Base Case. The base case assumes a gas-fired hot water boiler with 78% efficiency by default if gas is selected as the heating fuel;

Intention

Globally, space heating is one of the largest energy uses in buildings and often it is provided with fossil fuels. The specification of an efficient space heating system will reduce the energy required to satisfy the heating load for a building, and the resulting emissions.

Approach/Methodologies

To qualify, the space heating system must be able to demonstrate an efficiency level greater than the base case. Different metrics can be used to specify the efficiency of a system, for example, manufacturers might quote the gross efficiency, net efficiency, seasonal efficiency, or the annual fuel utilization efficiency (AFUE), each of which uses a different methodology to calculate the percentage. A user can enter either a percentage efficiency or a COP or EER in EDGE.

The user must select the appropriate space heating fuel type in the Design page and input the space heating system type and its efficiency rating in the Energy page. The default efficiency for the improved case appears when a system type is selected but can be overwritten. For example, the default efficiency of a condensing boiler is 95%. Actual efficiency must be input for the selected equipment if this measure is selected.

Where multiple systems with different efficiency ratings are specified, the dominant fuel type must be selected; the weighted average efficiency must be calculated accounting for capacity and the expected run time. Efficient systems can range from 97% efficient in the case of condensing boilers to more than 200% efficient in the case of heat pumps.

Potential Technologies/Strategies

EDGE has the following space heating system types available.

1. Heat Pumps – These typically use electricity, but gas-fired heat pumps are also available. Heat pumps may be packaged or split.
2. Condensing Boilers – These typically run on natural gas and achieve 97% efficiency or higher. They utilize the latent heat in the waste gases' water vapor which is generated by the combustion process. Condensing boilers have a larger heat exchanger that recovers more heat and sends cooler gases up the flue. Additional heat is extracted from the water vapor from combustion; the heat extraction converts the vapor into liquid or "condensate". This condensate is removed through the drain or the flue. The types of condensing boilers available in the market are as follows:

ENERGY EFFICIENCY MEASURES IN EDGE

Table 28: Types of Condensing Boiler

Type / method	Description
Heat-only boilers	<ul style="list-style-type: none"> Conventional boilers Provide both space heating and hot water Hot water storage cylinder and cold-water top-up tanks are required, plus a loft tank for feed and expansion
System boilers	<ul style="list-style-type: none"> The pump and expansion vessel are built-in, does not need a loft tank. Designed to generate space heating and service hot water, the latter stored in a separate hot water storage tank.
Combination boilers or 'Combi'	<ul style="list-style-type: none"> Combines a high-efficiency water heater and a central heating boiler in a compact unit Heats water instantaneously on demand Does not need a loft tank or storage cylinder Good water pressure, as water is directly from the mains Economical to run
Modulated control boilers	<ul style="list-style-type: none"> New generation More efficient because of the modulated controls

To achieve the best results, care must be taken not to oversize the boiler, since maximum levels of efficiency are achieved at a full load. In larger buildings with a centralized plant, like an education building, a modular system made up of an array of smaller boilers may be appropriate. Smaller boilers can be used so that when the system is under partial load, individual boilers within the array can still operate at full load. To minimize the cost of a boiler installation, the heat loads must be minimized before sizing the system.

- Electric Resistance
- Conventional Boiler
- Furnace
- Steam Boiler
- Generator Waste Heat. This measure can be claimed if an on-site power generator fueled by Diesel or Natural Gas provides power to the building, and a recovery technology is installed to capture the waste heat for space heating. Heat recovery collects and reuses the heat that would otherwise be lost. An electric generator typically has low efficiency and a large portion of the energy input is lost via the exhaust gases and in cooling the equipment jacket. The following image shows the different sources of waste heat and the uses of the recovered waste heat:

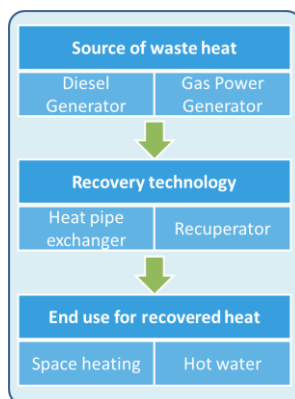

ENERGY EFFICIENCY MEASURES IN EDGE

Figure 20. Typical Sources of Waste Heat and Recovery Options⁴³

This waste heat can be turned into useful space heat with a recovery technology such as one of those indicated in the table below:

Table 29: Recovery technology options

Recovery Technology	Description
Thermal Energy Storage (TES)	Buffer tank where waste heat from different sources is stored and realized later to reduce the heating load during night time.
Seasonal Thermal Energy Storage (STES)	This technology is similar to TES but the heat is kept for longer periods of time, even months. Usually, the heat is stored in a bigger area where a cluster of heat-exchanger equipped boreholes is surrounded by bedrock.
Pre-heating	Simply put, waste heat can help to preheat incoming water, air and objects before they are heated to the desired temperature. This can happen in a heat exchanger, where the waste heat is mixed with the incoming air/water to increase its temperature before it enters a boiler or heater.
Cogeneration or Combined Heat and Power (CHP) system	This is a system that reduces the waste heat used in the generation of power; however, some limitations arise from the engineering cost/efficiency of using small temperature differences on the power generation.
Recuperator	This is a type of heat exchanger with simultaneous flow of hot and cold fluids along physically separated flow paths, transferring heat between the streams.
Heat Pipe exchanger⁴⁴	This type of heat exchanger has vacuum-sealed tubes filled with a working fluid (heat pipes) that are used to absorb heat from a warmer surface and transfer it to a cooler surface. The working fluid inside a heat pipe evaporates at the warmer surface and then travels to the colder surface where it transfers that latent heat and turns back into a liquid phase.

Recovering waste heat from power generators helps buildings to significantly reduce fossil fuel consumption, lower operating costs, and limit pollutant emissions. Buildings that use fossil fuel energy for heating and that have a power generator as the main electricity source have the potential to benefit. Recovering waste heat reduces heating energy consumption of utility fuel. However, the energy from pumps may increase slightly due to the operation of the waste heat recovery system. The user must select the appropriate fuel under 'Generator,' and input the appropriate value for '% of Electricity Generation Using [Fuel].' Justification and documentation must be provided for these key assumptions.

The space heating system size is affected by the heat gains and losses. Strategies to minimize heat loss must be employed during new construction as that is the most cost-effective.

Relationship to Other Measures

Only "Heating energy" is reduced with this measure.

⁴³ Source: Heat is Power Association. Trade association of Waste Heat to Power (Not-for-Profit organization)

⁴⁴ Source: Heat is Power Association. Trade association of Waste Heat to Power (Not-for-Profit organization)

ENERGY EFFICIENCY MEASURES IN EDGE

Compliance Guidance

Design Stage	Post-Construction Stage
<p>At the design stage, the following must be used to demonstrate compliance:</p> <ul style="list-style-type: none"> • Mechanical and electrical layout drawings showing the location of the external and internal components of the space heating equipment for all floors; and • Equipment Schedule or Manufacturer’s data sheets (with the project specific info highlighted & noted) for the space heating system specifying efficiency information • For systems including more than one type or size of space heating system, the design team must provide the weighted average efficiency calculations, calculated either within or outside the EDGE App. 	<p>At the post-construction stage, the following must be used to demonstrate compliance:</p> <ul style="list-style-type: none"> • Documents from the design stage if not already submitted. Include any updates made to the documents to clearly reflect As-Built conditions; and • Date-stamped photographs of the space heating equipment taken during or after installation showing the make and model; or • Purchase receipts for the space heating equipment showing the make and model; or • Contract with the management company showing the efficiency of the space heating system, if the system is under separate management or off-site. <p>Existing building projects</p> <ul style="list-style-type: none"> • If some of the documents required above are not available, other evidence of construction details, such as existing building drawings or photographs can be submitted.

EEM17 – ROOM HEATING CONTROLS WITH THERMOSTATIC VALVES

Requirement Summary

This measure can be claimed if the radiators for space heating are fitted with thermostatic valves to control the room temperature.

Intention

The intent of this measure is to reduce space heating demand. Space heating with radiators is typically provided in buildings with a central heating plant or district heating supply. When these radiators are not fitted with thermostatic valves, a common problem is that some spaces get uncomfortably hot even in winter and the occupants need to manually control radiators or open windows to regulate the room temperature. This results in significant wasted heat. The use of thermostatic valves will reduce this wasted heat.

Approach/Methodologies

When windows are opened on cold days to regulate the temperature in a space, the space heat that has already been generated is simply wasted. To recover this wasted heat, there is additional load on the space heating system.

To model this measure in EDGE, simply select the measure. EDGE models the savings automatically assuming that the radiant heaters have temperature control at room level, thus reducing the load on the heating system.

Potential Technologies/Strategies

Thermostatic valves are installed on radiators, which can be set to regulate the amount of heat being delivered to the space. This may be achieved by throttling the hot water or steam in the radiators.

Relationship to Other Measures

This measure only impacts the space heating energy use.

ENERGY EFFICIENCY MEASURES IN EDGE

Compliance Guidance

Design Stage	Post-Construction Stage
<p>At the design stage, the following must be used to demonstrate compliance:</p> <ul style="list-style-type: none"> • Mechanical system schematics showing the make and model, specifications, and location of the thermostatic radiator valves in the building; and • Manufacturer’s data sheets for the thermostatic radiator valves specified 	<p>At the post-construction stage, the following must be used to demonstrate compliance:</p> <ul style="list-style-type: none"> • Documents from the design stage if not already submitted. Include any updates made to the documents to clearly reflect As-Built conditions; and • Date-stamped photographs of the installed thermostatic valves showing the make and model; or • Purchase receipts for the thermostatic valves showing the make and model <p>Existing building projects</p> <ul style="list-style-type: none"> • If some of the documents required above are not available, other evidence of construction details, such as existing building drawings or photographs can be submitted.

EEM18 – DOMESTIC HOT WATER (DHW) SYSTEM EFFICIENCY

Requirement Summary

This measure can be claimed if the hot water system has an efficiency greater than the Base Case. Note that the baseline assumes Electricity as the fuel and a standard instantaneous electric water heater as the system, which has a nearly 100% efficiency. So, a standard electric water heater will not generate savings.

If this measure is selected, the actual fuel type must be input in the Design tab for the selected equipment, for example natural gas for a boiler, and the actual system type and efficiency must be input in the Energy tab.

Intention

Providing hot water with high efficiency will reduce fuel consumption and related carbon emissions from water heating.

Approach/Methodologies

To qualify, the system must be able to demonstrate efficiency greater than the base case. There are several different methodologies for calculating the efficiency of a water heating system. Manufacturers might quote the COP, thermal efficiency (TE), gross efficiency, net efficiency, seasonal efficiency, or the annual fuel utilization efficiency (AFUE), each of which uses a different methodology to calculate the percentage. EDGE uses COP as the measure of efficiency. COP data is available in the manufacturer specifications. If the COP rating is not available, Thermal Efficiency (TE) can be used instead.

To recognize energy reductions from installing solar collectors, a user must enter the proportion of hot water demand in the improved case that the solar collectors will deliver. EDGE uses this percentage to offset the amount of energy needed, displaying an approximate minimum area of collectors required to deliver the proportion of hot water demand. This will help auditors to check the size of the solar system against the EDGE estimate.

The amount of hot water delivered by the solar collectors is dependent on the amount of solar energy available, the roof pitch and profile, space available, shading factors, the orientation and angle of the solar collectors, and the type of solar collectors. The size of the storage tank also impacts the amount of hot water delivered, as a tank that is too small will reduce the quantity that can be stored. These factors should be considered by the design team.

Solar collector sizing calculators are available from manufacturers of solar collectors. Alternatively, online calculators or software can be used.

In some cases, solar collectors are centralized for a combination of buildings within the building project. In these cases, the central solar plant should be located within the site boundary of the project, or managed by a company within the control of the site owner. This is to ensure continued and sustainable management and access to the plant for future maintenance.

When solar hot water collectors are located off-site, then a contract with the management company in charge of the PV system must be provided as part of the documentation at post-construction stage.

ENERGY EFFICIENCY MEASURES IN EDGE

The default improved case in EDGE assumes 50% of total hot water demand in the improved case being met by a solar thermal installation. The default value of 50% must be overwritten by the user with the actual percentage applicable to the project. The area of the collector required to deliver the stated proportion of hot water demand assumes that flat plate collectors are used, and assumes that the collectors are installed at an optimum angle.

Potential Technologies/Strategies

Heat pump water heaters (HPWH)

HPWH use electricity to take the heat from surrounding air and transfer it to the water in an enclosed tank. This process is like the heat transfer process in a refrigerator but in reverse. Heat pump water heaters can be used with dual functionality in hotels for example to cool the kitchen, laundry, or ironing area and to generate hot water. Because they move heat rather than generate heat, heat pumps can provide efficiencies greater than 100%.

The efficiency of a heat pump is indicated by the Coefficient of Performance (COP). It is determined by dividing the energy output of the heat pump by the electrical energy needed to run the heat pump, at a specific temperature. The higher the COP, the more efficient the heat pump. Typical heat pump water heaters are two to three times more efficient than standard electric water heaters.

Type	Process
Heat Pump Water Heaters	A low-pressure liquid refrigerant is vaporized in the heat pump's evaporator and passed into the compressor. As the pressure of the refrigerant increases, so does its temperature. The heated refrigerant runs through a condenser coil within the storage tank, transferring heat to the water stored there. As the refrigerant delivers its heat to the water, it cools and condenses, and then passes through an expansion valve where the pressure is reduced and the cycle starts over.
Air-source Heat Pumps	These systems are called "integrated" units because they integrate the heating of domestic water with a house space-conditioning system. They recover heat from the air by cooling and transferring heat to domestic hot water. Water heating can be provided with high efficiency with this method. Water heating energy can be reduced by 25% to 50%.
Ground-Source Heat Pumps	In some Ground-Source Heat Pumps, a heat exchanger, sometimes called a "desuperheater," removes heat from the hot refrigerant after it leaves the compressor. Water from the home's water heater is pumped through a coil ahead of the condenser coil, in order that some of the heat that would have been dissipated at the condenser can be used to heat water. Excess heat is always available in the summer cooling mode, and is also available in the heating mode during mild weather when the heat pump is above the balance point and not working to full capacity. Other ground-source heat pumps

ENERGY EFFICIENCY MEASURES IN EDGE

Type	Process
	<p>provide domestic hot water (DHW) on demand: the whole machine switches to providing DHW when it is required.</p> <p>Water heating is easier with ground-source heat pumps because the compressor is located indoors. They generally have many more hours of surplus heating capacity than required for space heating, because they have constant heating capacity.</p> <p>Like air-source heat pumps, ground-source heat pumps can reduce water heating consumption by 25% to 50%, as some have a desuperheater that uses a portion of the heat collected to preheat hot water, and also can automatically switch over to heat hot water on demand.</p>

Boilers

Even the most efficient boilers have a maximum efficiency around 98%, because some energy (heat) is lost via the flue gases and through the main body of the boiler itself; also, lack of maintenance can reduce a boiler's efficiency.

The following table shows a set of solutions related to hot water boilers.

Table 30: Types of High Efficiency Hot Water Boilers⁴⁵

Type	Description
Condensing boilers	The only boilers likely to achieve efficiency level of at least 90%. They extract latent heat from the waste gases' water vapor that is generated by the combustion process. To minimize the cost of a boiler installation, hot water demand should be minimized before sizing the system.
Combi Boiler	This is a type of condensing boiler that provides both heating and hot water without needing a separate tank.
Low temperature hot water (LTHW) boilers	Produce hot water at around 90°C, which is then distributed via pipework to a hot water storage tank. These boilers commonly run on Natural Gas, but may also be LPG.
High-efficiency boilers	These generally have lower water content, larger heat exchanger surface areas and greater insulation of the boiler shell. They are suitable to applications where a higher water temperature is required, such as kitchens, laundry and showers.

⁴⁵ The Carbon Trust. Low temperature hot water boilers. UK: March 2012. https://www.carbontrust.com/media/7411/ctv051_low_temperature_hot_water_boilers.pdf

ENERGY EFFICIENCY MEASURES IN EDGE

“Staged” multiple-boiler system	Reduces the amount of time in which a boiler is running at less than peak load, since only few boilers run depending on the demand. So, in the peak times more boilers are in use while during the off-peak times only the boilers to cover a small demand will be active.
Modular boiler systems	Series of boilers linked together to meet different demands; they are suitable for buildings or processes with a significant variable hot water/heating demand. Modular systems are generally composed of several identical boiler units although a mix of condensing and conventional boilers could be used.

Solar Hot Water

The two types of solar thermal hot water collectors are flat plate and evacuated tube. Both types of solar collectors should ideally be installed at a tilt angle that takes advantage of the most useful altitude angles of the sun to maximize the solar heat available. This angle is approximately equal to the building location’s latitude. The collectors should be angled towards the equator (towards the south in the northern hemisphere, and towards the north in the southern hemisphere). If this is not possible then facing the panels towards the southeast, southwest or even west is also acceptable, but panels should not be installed to face north in the northern hemisphere, and towards the south or east in the southern hemisphere. Solar collectors can also be installed horizontal to the ground. This is optimal in locations where the sun’s azimuth (angle of the sun from the horizon) is vertically overhead at the desired peak production times. Where the sun is at other angles, the efficiency is adversely affected.

Table 31: Types of solar water collectors

Type	Description
Flat Plate Collectors	As their name suggests, they are flat and typically black. They are the most commonly used collectors and are the cheapest option. Flat plate collectors consist of an absorber plate, which is usually black chrome; a transparent cover which protects the absorber plate and reduces heat loss; tubes containing a fluid to take heat from the absorber plate; and an insulated backing.
Evacuated Tube Collectors	Evacuated tubes consist of a row of glass tubes. These glass tubes each contain an absorber plate fused to a heat pipe containing heat transfer fluid.

Relationship to Other Measures

This measure is inextricably linked to hot water consumption, which EDGE estimates based on the number of occupants, the efficiency of the hot water boiler, and the flow rates of the kitchen, showers, laundry and hand basin faucets. The size of the required system can therefore be reduced significantly by specifying low-water-use showers and faucets, as well as any water heating recovery technology.

This measure reduces both ‘Water Heating’ and ‘Other’ categories of energy use due to the reduction of pumping requirements for water.

ENERGY EFFICIENCY MEASURES IN EDGE

Compliance Guidance

Design Stage	Post-Construction Stage
<p>At the design stage, the following must be used to demonstrate compliance:</p> <ul style="list-style-type: none">• Mechanical and electrical layout drawings showing the location of the water heating equipment for all floors, clearly showing any solar or heat pump water heaters; and• In the case of solar water heating, briefly describe the system including the type of solar collector, the capacity of the storage tank and its location, and the size, orientation and installed angle of the panels.• Equipment Schedule or Manufacturer’s data sheets (with the project specific info highlighted & noted) for the water heating system(s) specifying efficiency information• For systems including more than one type or size of water heating system, the design team must provide the weighted average efficiency calculations, calculated either within or outside the EDGE App.	<p>At the post-construction stage, the following must be used to demonstrate compliance:</p> <ul style="list-style-type: none">• Documents from the design stage if not already submitted. Include any updates made to the documents to clearly reflect As-Built conditions; and• Date-stamped photographs of the water heating equipment taken during or after installation showing the make and model; or• Purchase receipts for the water heating equipment showing the make and model; or• Contract with the management company showing the efficiency of the water heating system, if the system is under separate management or off-site. <p>Existing building projects</p> <p>If some of the documents required above are not available, other evidence of construction details, such as existing building drawings or photographs can be submitted.</p>

ENERGY EFFICIENCY MEASURES IN EDGE

EEM19 – DOMESTIC HOT WATER PREHEATING SYSTEM

Requirement Summary

This measure can be claimed if a heat recovery device is installed to capture and reuse waste heat with at least 30% efficiency. If this measure is selected, the assumptions for fuel type and system type must also be verified.

Intention

Recovering waste heat to preheat the water supplied to the hot water system helps buildings to reduce the design capacity of water heaters, and lower associated fossil fuel consumption, operating costs, and pollutant emissions. For example, hospitals that use a power generator as a significant source of electricity and energy for hot water can reap benefits from the use of heat recovery systems such as lower maintenance, quieter operation, and higher availability of hot water, as well as reducing energy costs and carbon emissions from lower fuel consumption.

Approach/Methodologies

Waste heat is recovered from a source such as gray water, a heat recovery chiller, or a power generator. In the case of gray water, the efficiency of heat recovery device should be input. In the case of a generator providing waste heat, the fuel used for electricity generation and the percentage of annual electricity provided by the generator should be marked in the Design page under the Fuel Usage panel. The default fuel is Diesel. It can be changed to reflect the actual fuel powering the generator. The basis of fuel selection and percentage electricity generation must be included in the measure documentation.

To qualify, the design team must demonstrate that the Hot water system has a 'heat recovery' device. The EDGE base case assumes no heat recovery from gray water, while the improved case assumes that all the hot water discharge passes through a heat recovery system with 30% efficiency (can be updated by the user), therefore a portion of the hot water demand is covered by the recovery of the waste heat.

In the case of heat recovery from a generator, the default fuel is assumed to be Diesel. The fuel selection can be changed in the Design page to reflect the actual fuel powering the generator.

Potential Technologies/Strategies

Heat recovery in buildings aims to collect and reuse the process heat waste that would otherwise be lost. Sometimes, the rejection of this heat is intentional, such as in air conditioning, where the purpose is to remove heat from a space. But using a recovery technology, such waste heat can be used to preheat the water feeding the hot water system.

EDGE offers three options for heat recovery. Other options can be modeled by using one these three as a proxy.

Gray Water Heat Recovery

A drainpipe carrying warm gray water (drain water from showers, kitchens, laundry, spa area, etc.) can be fitted with a heat exchanger to absorb that waste heat into the incoming cold-water pipes leading directly to

ENERGY EFFICIENCY MEASURES IN EDGE

water fixtures or to preheat the water being supplied to the hot water heater. Various commercial solutions are available for gray water heat recovery, ranging from non-storage systems (shower-only recovery) to centralized heat recovery, which connects more equipment and augments the possibilities for use of the recovered energy. The following table shows some of the solutions:

Table 32: Gray Water Heat Recovery Solutions

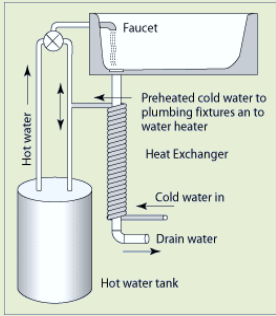
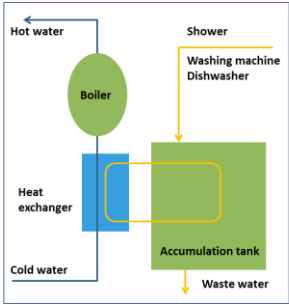
Types		Description
<p>Spiral design (non-storage)</p>		<p>Hot water runs through a series of narrow spirals in which it is forced to spin alongside the walls of the heat recovery pipe. The cold water then comes as a counter flow in a spiral pipe swirled around the outside. This design requires small gaps (2cm) to avoid plugging.</p> <p>It is commonly used in residential and small hotels or hospitals.</p> <p>Instead of a spiral system, tubular or rectangular heat exchanger systems can also be used.</p>
<p>Accumulation tank (centralized)</p>		<p>Gray water from different sources is accumulated in a tank, which has an electrical coil (close loop) that transfers the heat to the cold water passing through the gray-water heat recovery unit outside the tank.</p>
<p>Parallel heat exchanger (centralized)</p>		<p>This is ideal for larger buildings such as hospitals, as it collects the gray water in one pipe that passes through the heat exchanger. It is like spiral design but used centrally rather than in each unit.</p>

Heat Recovery from Chiller

Chillers reject large amounts of heat from the condenser using air or water. In water-cooled chillers, water that has been warmed up from the heat rejection process can be used to preheat the incoming water supply for water heating.

Generator Waste Heat

Electricity generators are typically fueled by diesel and operate at relatively low efficiencies, therefore creating a significant amount of waste heat. This waste heat can be captured using heat exchangers to preheat the water supply for the water heating systems.

ENERGY EFFICIENCY MEASURES IN EDGE

Relationship to Other Measures

This measure reduces both 'Water Heating' and 'Other' due to pumping water in the system. This measure can also be used to reduce the size of the boiler.

The energy use for hot water that is being reduced using heat recovery is affected primarily by the rate of hot water use. Hot water use should be minimized first by selecting low-flow taps in washbasins and low-flow showerheads.

Compliance Guidance

Design Stage	Post-Construction Stage
<p>At the design stage, the following must be used to demonstrate compliance:</p> <ul style="list-style-type: none">• Mechanical and electrical layout drawings showing the location and specifications of the water preheating technology, such as heat recovery from gray water or laundry wastewater, chiller or generator; and• Manufacturer's data sheets for the recovery technology used and its efficiency; and• Calculation to demonstrate that the waste heat covers the percentage of the demand for hot water calculated by the EDGE software.	<p>At the post-construction stage, the following must be used to demonstrate compliance:</p> <ul style="list-style-type: none">• Documents from the design stage if not already submitted. Include any updates made to the documents to clearly reflect As-Built conditions; and• Date-stamped photographs of the heat recovery equipment taken during or after installation showing the make and model; or• Purchase receipts for the heating recovery equipment showing the make and model. <p>Existing building projects</p> <ul style="list-style-type: none">• If some of the documents required above are not available, other evidence of construction details, such as existing building drawings or photographs can be submitted.

ENERGY EFFICIENCY MEASURES IN EDGE

EEM20 – ECONOMIZERS

Requirement Summary

This measure can be claimed if the HVAC system includes economizers. Critical areas with special needs for indoor air quality, such as Operation Theatres (OT) and/or the Intensive Care Units (ICU) in hospitals, are exempt from the requirement of air-side economizers. Water-side economizers can still be used in these areas. The base case system and default improved case do not include economizers.

Intention

Cooling energy use can be reduced in buildings when outside air conditions are suitable to cool the building with little or no need for mechanical cooling.

Approach/Methodologies

EDGE software uses monthly average outdoor air temperatures based on the project location to estimate the suitability of an economizer for the project.

Following are the temperature setpoints for air-side and water-side economizers.

Temperature Setpoint	Type of Economizer
15 °C	Air-side Economizer
25° C	Water-side Economizer

- When the outdoor dry bulb temperature is less than or equal to the setpoint, the economizer is activated.

Potential Technologies/Strategies

Two types of economizers are commonly used.

Air-side Economizers

The effectiveness of air-side economizers is highly dependent on the outside air temperature and humidity levels, which are measured through an outdoor sensor in the economizer system. Under suitable conditions, the outside air damper is fully open and the cooling compressors are turned down or shut off.

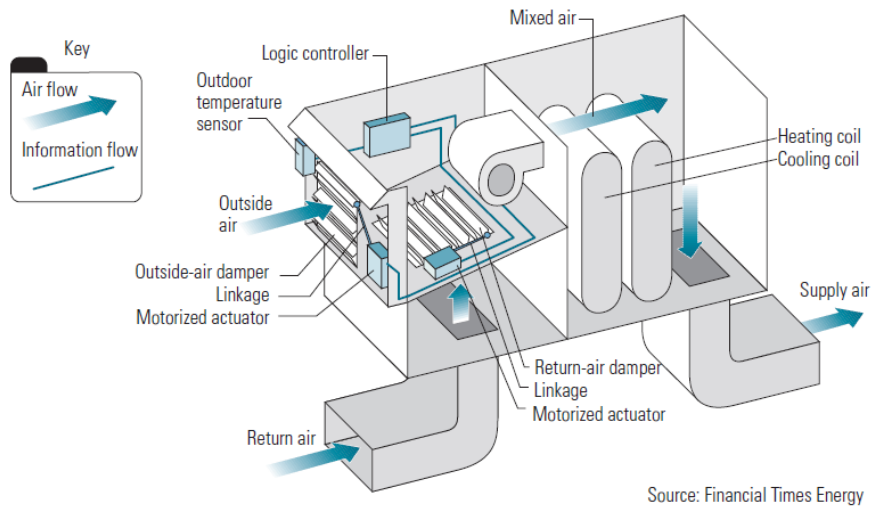

Figure 21. Components of an air-side economizer system⁴⁶

A decision on the inclusion of economizers should be based on analysis of outdoor air temperature and humidity in comparison to the desired indoor temperatures. While this measure has potential to reduce cooling energy significantly in some locations, increased capital and operating costs are possible if the system is not designed and maintained properly.

Air-side economizers should typically be avoided in following circumstances:

- Especially corrosive climates, such as near an ocean
- Hot and humid weather
- Scarcity of sufficiently trained maintenance staff

Water-side Economizers

A water-side economizer uses the evaporative cooling capacity of a cooling tower to produce chilled water. Such an economizer can be used instead of a chiller at a data center during the winter months. Water-side economizers offer cooling redundancy because they can provide chilled water if a chiller goes offline. This can reduce the risk of cooling system down time.

⁴⁶ Source: Image courtesy of Energy Design Resources (www.energydesignresources.com),

ENERGY EFFICIENCY MEASURES IN EDGE

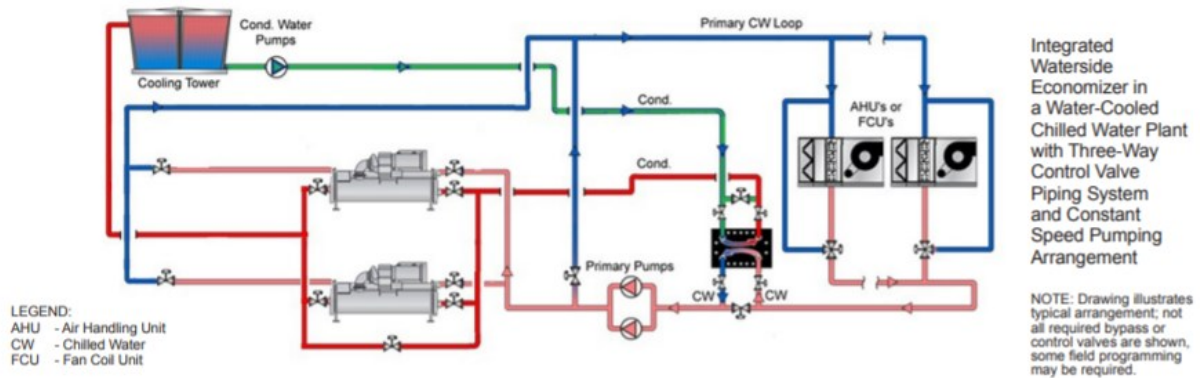

Figure 22. Integrated Water-Side Economizer in a Water-cooled Chilled Water plant with 3-way Control Valve Piping System and Constant Speed Pumping System⁴⁷

Relationship to Other Measures

Economizers reduce the need for mechanical cooling. Therefore, while the overall savings will increase, savings from improvement in cooling efficiency by itself will be reduced.

Compliance Guidance

To demonstrate compliance, the design team must describe the specified system and provide documentation to support the claims.

Design Stage	Post-Construction Stage
<p>At the design stage, the following must be used to demonstrate compliance:</p> <ul style="list-style-type: none"> • System schematics showing the location, brand and model of the air economizers; and • Manufacturer’s data sheets for the air economizers specified. 	<p>At the post-construction stage, the following must be used to demonstrate compliance:</p> <ul style="list-style-type: none"> • Documents from the design stage if not already submitted. Include any updates made to the documents to clearly reflect As-Built conditions; and • Date-stamped photographs of the economizers taken during or after installation showing the make and model; or • Purchase receipts for the economizers showing the make and model. <p>Existing building projects</p> <ul style="list-style-type: none"> • If some of the documents required above are not available, other evidence of construction details, such as existing building drawings or photographs can be submitted.

⁴⁷ Image courtesy [Carrier Corporation](#)

EEM21 – DEMAND CONTROL VENTILATION USING CO₂ SENSORS

Requirement Summary

Mechanical ventilation in principal areas of the building can be controlled by CO₂ sensors. At least 50% of the building ventilation system should be controlled by CO₂ sensors to claim this measure.

Intention

Mechanical ventilation introduces fresh air into the space. By installing CO₂ sensors in the principal areas and covering at least 50% of the building, mechanical ventilation can be switched off when it is not required, thus consuming lesser energy. While the primary benefit of the CO₂ sensors is the reduction of energy bills, the following are the other associated benefits:

- Improved and consistent indoor air quality
- Occupant comfort
- Reduced greenhouse gas emissions; and
- Extended equipment life due to less demand on the HVAC system

It is recommended that the control system take frequent measurements of CO₂ levels to adjust the ventilation supply to maintain proper indoor air quality.

Approach/Methodologies

No calculations are involved in the assessment of this measure. To claim that it has been achieved, the principal areas of the building must have CO₂ sensors to control ventilation, covering at least 50% of the building floor area.

The base case assumption is that the mechanical ventilation is provided at a fixed rate.

Potential Technologies/Strategies

The amount of mechanical ventilation can be controlled to only provide fresh air to spaces at the time that it is required. This reduces the energy consumed by the HVAC system. Traditional ventilation systems are designed to provide a constant volume of fresh air based on maximum occupancy⁴⁸. However, at partial occupancy levels, energy is wasted to condition outside air provided through the mechanical ventilation system even when it is not needed. The level of Carbon Dioxide (CO₂) in the air exhaled by people serves as a useful indicator of the room's occupancy levels, and therefore its ventilation needs.

⁴⁸ Commercial HVAC, Manitoba Hydro. 2014. https://www.hydro.mb.ca/your_business/hvac/ventilation_co2_sensor.shtml

ENERGY EFFICIENCY MEASURES IN EDGE

CO₂ sensors are therefore a type of controls based on demand for the mechanical ventilation system, which reduce energy consumption while ensuring good air quality. The savings vary depending on the configuration of the HVAC system. For constant volume air-handling units (AHUs), the savings occur at the primary systems (boilers, chillers, air-conditioners, etc.), while for variable-air-volume (VAV) AHUs, the savings occur not only at the primary systems but also at the terminal boxes that include reheat⁴⁹. The following image explains the way CO₂ sensors operate in both cases:

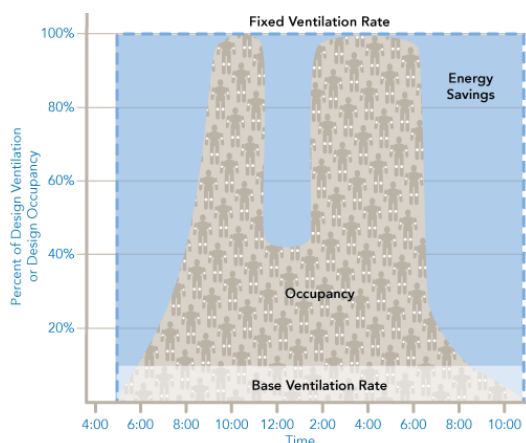

Figure 23. Energy savings due to CO₂ sensors. Source²³

ASHRAE Standard 90.1-2004 recommends that the building incorporate any type of Demand Controlled Ventilation (DCV), which includes CO₂ sensors, when the building has a density greater than 100 people and when the AHU has an outdoor air capacity greater than 3,000 ft³/min. The following specifications are recommended in ASHRAE 90.1-2004 for the selection of the CO₂ sensor:

- Range: 0-2,000 ppm
- Accuracy (including repeatability, non-linearity and calibration uncertainty): +/- 50 ppm
- Stability (allowed error due to aging): <5% Full Scale for 5 years
- Linearity (maximum deviation between a reading and the sensor's calibration curve): +/- 2% Full Scale
- Manufacturer recommended minimum calibration frequency: 5 years

Relationship to Other Measures

CO₂ sensors are controls for the mechanical ventilation system that can reduce the amount of cooling or heating energy, as well as fan energy, used by the HVAC system as less outside air is moved into the building. In addition, if the building uses a water-cooled chiller for the AC, then a reduction in the water consumption is also achieved.

⁴⁹ Design brief: Demand-controlled ventilation, Energy Design Resources. 2007.
http://energydesignresources.com/media/1705/EDR_DesignBriefs_demandcontrolledventilation.pdf?tracked=true

ENERGY EFFICIENCY MEASURES IN EDGE

Compliance Guidance

Design Stage	Post-Construction Stage
<p>At the design stage, the following must be used to demonstrate compliance:</p> <ul style="list-style-type: none"> • HVAC layout drawings showing the location of the CO₂ sensors for the ventilation system including the mounting height; and • Manufacturer specifications of the sensors. 	<p>At the post-construction stage, the following must be used to demonstrate compliance:</p> <ul style="list-style-type: none"> • Documents from the design stage if not already submitted. Include any updates made to the documents to clearly reflect As-Built conditions; and • Date-stamped photographs of the CO₂ sensors taken during or after installation showing the make and model; or • Purchase receipts for the CO₂ sensors showing the make and model. <p>Existing building projects</p> <ul style="list-style-type: none"> • If some of the documents required above are not available, other evidence of construction details, such as existing building drawings or photographs can be submitted.

EEM22 – EFFICIENT LIGHTING FOR INTERNAL AREAS

Requirement Summary

This measure can be claimed if the light bulbs used in the project are high-efficiency LED. Certain linear fluorescent lamps (T8 or T5) or compact fluorescent (CFL) may also qualify for some building types.

This measure cannot be claimed for spaces that are not fitted with efficient lighting fixtures. For example, if an office building for lease is not fitted with lighting fixtures for tenants and there is no provision for efficient lighting in a binding lease agreement or similar provision, then this measure cannot be claimed for those spaces.

Table 33 shows the indoor spaces that are required to have at least 90% of the lamps to be of the efficient type, by building typology. Where there is more than one row for a building type, each row represents a separate measure that can be claimed individually. This measure cannot be claimed for spaces that are not fitted with efficient lighting fixtures. For example, if an office building for lease is not fitted with lighting fixtures for tenants and there is no provision for efficient lighting in a binding lease agreement or similar provision, then this measure cannot be claimed for those spaces.

Table 33: Indoor spaces required to have efficient lighting, by Building Type

Building Type	Internal spaces that must have efficient lighting
Homes	All habitable spaces (including living rooms, dining rooms, kitchens, bathrooms, and corridors) Shared corridors, Common areas, Staircases
Hospitality	All guest spaces (including guest rooms, bathrooms, conference/banquet rooms, corridors, etc.) Back-of-the-house (including kitchens, laundry, health spa, storage area, etc.)
Retail	Sales area Corridors and common areas
Offices	All internal spaces (including offices, circulation area, lobby, storage, restrooms, etc.)
Hospitals	All, except Operation theaters Basement, car parking, and kitchen
Education	All internal spaces

ENERGY EFFICIENCY MEASURES IN EDGE

Intention

Efficient lamps, that produce more light with less power compared to standard incandescent bulbs, reduce the building's energy use for lighting. Due to the reduction in waste heat from efficient lamps, heat gains to the space are also lowered, which in turn reduces cooling requirements. Maintenance costs are also reduced as the service life of these types of bulbs is longer than that of incandescent bulbs.

Approach/Methodologies

Lighting efficiency at the building level can be expressed in one of two ways in EDGE, either as lighting power density (watts/square meter) or as luminous efficacy (lumens/watt). Here, watts/square meter (W/m^2) is the amount of power draw per square meter (lower is better), while lumens per watt (lm/W) is the measure of lighting efficacy to produce visible light output measured in lumens per watt of power draw (higher is better). e.g., if a 40W light bulb has a power draw of 40W and produces about 450 lumens⁵⁰, the efficacy of this 40 W lamp would be $450/40$ or 11.25 lm/W .

Space-by-space input can also be entered into EDGE using the Calculator accessed from the options menu, if the project team needs to differentiate between space types in a building.

If detailed inputs are not used, at least 90% of the lamps must be of the efficient type. Documentation must be provided to demonstrate that the light fixtures achieve performance better than baseline.

EDGE does not account for lighting quality, illumination (lux or lumen) levels, or lighting layout. These should be handled by the lighting designer using local or international lighting design code requirements. Besides lamp efficiency, the key indicators are the color rendering index (CRI), color temperature (in Kelvin), and service life.

- CRI is a good indication of the quality of the light produced. The higher the CRI, the better the colors will be rendered.
- Color temperature is warmer for smaller numbers (1500-3000K) and whiter for higher numbers (4000-6000K) with 6000K being close to daylight; the appropriate color temperature will depend on the application.
- A longer service life is better for cost reductions in maintenance and bulb replacements.

Light bulbs covered by the EDGE lighting measure exclude safety and security lighting.

The default assumption for the EDGE base case is that the lighting fixtures are mostly fitted with LED lamps of at least 65 lm/W with an occasional incandescent lamp. The improved lighting density assumes that at least 90% lamps in the improved case are of a more efficient type of LED.

Potential Technologies/Strategies

Fluorescent (e.g., T8 and T5) and LED bulbs are available with various high-performance specifications.

The following table explains the different technologies for the recommended energy saving light bulbs:

⁵⁰ <http://clark.com/technology/lightbulbs-watt-to-lumen-conversion-chart/>

ENERGY EFFICIENCY MEASURES IN EDGE

Table 34: Description of technologies (lamp types)

Lamp Type	Description
Compact fluorescent lamps (CFLs)	<p>CFLs are available for most light fittings as a direct replacement for incandescent bulbs. CFLs use a fluorescent tube that has been folded into the shape of the incandescent bulb they have been designed to replace. In comparison to incandescent bulbs, CFLs can last as much as 15 times longer. It should be noted that the service life can be reduced by frequent switching, so CFLs are not always appropriate where lights will be turned on and off frequently. CFLs use only a fraction of the energy of their incandescent alternatives and therefore produce less heat.</p> <p>As with normal fluorescent lamps, CFLs require ballasts to operate. Older lamps use magnetic ballasts, but these have largely been replaced with electronic ballasts that operate at a high frequency. Although the efficacy is not affected, electronic ballasts have reduced warm-up times and flickering, which were issues with the earlier CFLs.</p>
Light emitting diode (LED)	<p>LED technology has evolved quickly and there are LED lamps available for most light fittings, and in different color temperatures ranging from warm white to daylight. The efficacy levels of LEDs are much higher than CFLs. The service life of LED lamps can be as much as two to three times the longest life of any available compact fluorescent lamp, and is not affected by frequent on/off cycles. Over the last few years, the performance of LED lamps has improved greatly while prices have dropped sharply, and they are now highly cost-effective.</p>
T5 and T8 lamps	<p>The name of these fluorescent tubes refers to their shape (tubular) and diameter (5 units measured in 1/8s of an inch, or 8 units measured in 1/8 of an inch). T5s have a miniature G5 bi-pin base with 5mm spacing, while T8s and T12s have a G13 bi-pin base with 13mm spacing. T12 to T5 conversion kits are available. Dedicated T5 luminaires can be specified in new construction projects, as using ballasts designed for T8s and T12s could reduce the service life of T5s. Newer T8s also have high performance and can operate efficiently at a wider temperature range than T5s.</p>

Although the efficacy of bulbs from different manufacturers will differ, **Table 35** gives an approximate range of efficacies that can be expected for different bulb technologies.

Table 35: Typical range of efficacies for different lamp types⁵¹

Lamp Type	Typical Range of Efficacy (Lumens/Watt)	Rated lifetime (hours)
Incandescent – Tungsten Filament (conventional bulbs)	10-19	750-2,500
Halogen lamp	14-20	2,000-3,500
Tubular Fluorescent (T5, T8 and T12)	25-92	6,000-20,000
Compact Fluorescent (CFL)	40-70	10,000
High Pressure Sodium	50-124	29,000
Metal Halide	50-115	3,000-20,000
Light Emitting Diode (LED)	50-100	15,000-50,000

⁵¹ Source: <https://www.eia.gov/consumption/commercial/reports/2012/lighting/> Data from the 2011 Buildings Energy Data Book, Table 5.6.9, Office of Energy Efficiency and Renewable Energy, U.S. Department of Energy

ENERGY EFFICIENCY MEASURES IN EDGE

Relationship to Other Measures

Using more efficient bulbs reduces the heat gain from lighting, thereby reducing cooling loads. Heating loads may also increase in a heating dominated climate. Another related measure is daylighting; better daylight design can reduce the need for artificial lighting during the daylit hours.

Compliance Guidance

To demonstrate compliance, the design team must provide the following documentation to support their claims.

Design Stage	Post-Construction Stage
<p>At the design stage, the following must be used to demonstrate compliance:</p> <ul style="list-style-type: none">• Electrical layout drawings showing the location and type of all interior lighting fixtures; and• Lighting schedule listing the type and number of lamps specified for all fixtures; and• Manufacturer’s data sheets or calculations showing that the lamps meet the minimum lumens per watt threshold.	<p>At the post-construction stage, the following must be used to demonstrate compliance:</p> <ul style="list-style-type: none">• Documents from the design stage if not already submitted. Include any updates made to the documents to clearly reflect As-Built conditions; and• Date-stamped photographs of the installed lighting; it is not necessary to take photos of every single installed lamp, but the auditor is responsible for checking and verifying a reasonable proportion; or• Purchase receipts for the lighting. <p>Existing building projects</p> <ul style="list-style-type: none">• If some of the documents required above are not available, other evidence of construction details, such as existing building drawings or photographs can be submitted.

EEM23 – EFFICIENT LIGHTING FOR EXTERNAL AREAS

Requirement Summary

The requirements for this measure are the same as for the previous measure “EEM22 - Efficient Lighting for Internal Areas,” except that they apply to external areas; so, any reference to interior lighting should be replaced with exterior lighting.

The required spaces with efficient bulbs vary by building type. **Table 36** shows the outdoor spaces that are required to have at least 90% of the lamps to be of the efficient type. At least 90% of the lamps must be of the efficient type.

Table 36: Outdoor spaces required to have efficient lighting, by Building Type

Building Type	External spaces that must have efficient lighting
Homes	Outdoor areas
Hospitality	Common outdoor spaces, such as outdoor garden
Retail	Common outdoor spaces, such as outdoor garden
Offices	Common outdoor spaces, such as outdoor garden,
Hospitals	Common outdoor spaces, such as outdoor garden
Education	Outdoor spaces of the project, such as a sports field

ENERGY EFFICIENCY MEASURES IN EDGE

EEM24 – LIGHTING CONTROLS

Requirement Summary

This measure can be claimed if lighting in all the required rooms are controlled using technologies such as occupancy sensors, timer controls, or daylight sensors. **Table 37** shows the spaces and the controls required to claim this measure, depending on the building type.

Table 37: Lighting Control Requirements by Building Type

Building Type	Spaces required to have lighting controls	Control type required
Homes	Shared corridors, Common areas, Staircases, and Outdoor areas	Photoelectric switching or dimming, occupancy sensors, or timer controls
Hospitality	Corridors, common areas, staircases, and outdoor areas	Photoelectric switching or dimming, occupancy sensors, or timer controls
	Bathrooms	Occupancy sensors
Retail	Bathrooms	Occupancy sensors
Offices	Corridors, Staircases	Daylighting controls
	Bathrooms, Conference Rooms, and Closed Cabins	Occupancy Sensors
	Open Offices	Occupancy Sensors
	All internal spaces with access to natural light	Daylight Photoelectric Sensors
Hospitals	Corridors	Daylighting controls
	Bathrooms	Occupancy Sensors
	All internal spaces with access to natural light	Daylight Photoelectric Sensors
Education	Bathrooms	Occupancy Sensors
	Classrooms	Occupancy Sensors
	Corridors	Occupancy Sensors
	All internal spaces with access to natural light	Daylight Photoelectric Sensors

ENERGY EFFICIENCY MEASURES IN EDGE

Space-by-space controls can be specified for the Improved Case using the Calculator in the Options menu.

Intention

By installing lighting controls in rooms, lighting usage is reduced. Lighting use may be reduced by using occupancy sensors to reduce the possibility for lights to be left on when the room is unoccupied, or by using photoelectric sensors when sufficient natural light is available. Reduced lighting use leads to a reduction in energy consumption.

Approach/Methodologies

No calculations are involved in the assessment of this measure. To claim that it has been achieved, the lighting in all the required rooms must be connected to lighting controls. In the case of lighting controls for daylighting, all ambient lighting in "daylight zones" which have access to exterior windows, or skylights, must be connected to an automatic daylight control system using photosensors. Daylight zones next to windows are defined as the perimeter space near a window with a depth = $1.5 \times$ head height of the window from the floor.

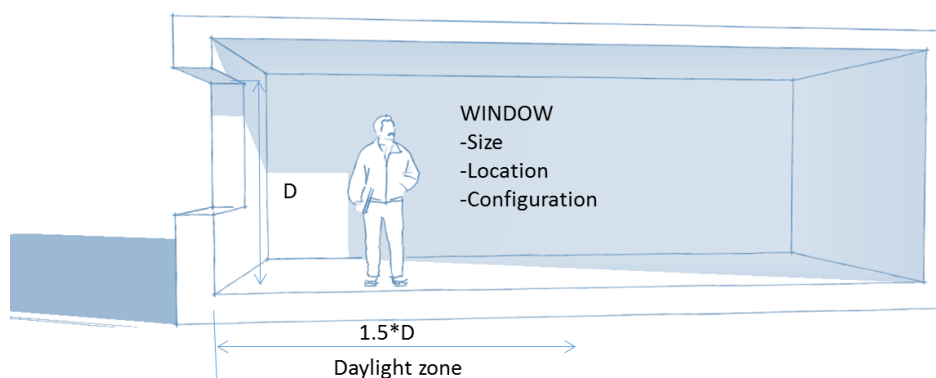

Figure 24. Daylight zone configuration

The base case assumption is that manual controls will be used for the control of all lighting. The improved case assumes that these spaces will have technology to reduce lighting usage by a certain amount.

In the case of daylighting, the improved case assumes that all occupied perimeter spaces with windows will have automated daylight controls that will switch off electric lights during some part of the day. The amount of savings will depend on the geographical location and building geometry defined in the "Building Lengths" section of the Design tab.

ENERGY EFFICIENCY MEASURES IN EDGE

Potential Technologies/Strategies

Occupancy sensor controls

Occupancy sensor controls are effective in saving lighting energy in spaces that have varying occupancy over the working hours. If many of the spaces in a building are expected to be unoccupied during some hours of the day, such as a conference room or a classroom, this measure may be considered.

Selection of the type of sensor and its location is critical for this measure. The sensor should be situated such that it can “see” all the occupants in the room. If the room is small enough, this could be done by placing the sensor in one corner of the room near the ceiling. For larger rooms, multiple sensors may be used.

Table 38 lists various types of controls with their pros and cons. Typically, occupancy sensors are used to control ambient lighting only. However, task lights, such as table lamps and under-cabinet lights may also be controlled by automatic sensors. Individual power strips equipped with in-built occupancy sensors may be used for this purpose.

Table 38: Types of controls for lighting and other equipment

Type	Description
Timer Controls	<p>The two types of timer controls are: time delay switches and actual timer controls.</p> <p>Time delay switches are manually switched on and then automatically switch off after a set time, which can be adjusted. Time delay or time lag switches can either be mechanical (pneumatic time delay) where the lighting requirement is less than 30 minutes, or they can be electronic, which can be programmed to provide a longer delay. A time delay switch is most appropriate in spaces where lighting is only used for short periods of time, such as bathrooms in common areas or rarely-used corridors.</p> <p>Timer controls use a built-in clock function to switch on and off at preset times. They can either be used to switch lights off when the lighting is unlikely to be required (such as security lighting during daylight hours), or to switch lights on at a set time (such as decorative lighting). Timer controls should always be fitted with a manual override so that out-of-hours use is still possible if required.</p>
Occupancy or Presence Detectors	<p>Occupancy or presence detectors can be used to switch lights on when movement or presence is detected and switch them off again when no movement or presence is detected. These may be used in areas of infrequent use by staff and public. Some technologies are as follows:</p> <ul style="list-style-type: none"> • <i>High frequency ultrasonic sensors</i>, detect occupancy by emitting a high-frequency signal, which they receive back as a reflected signal using the Doppler effect, and interpret change in frequency as motion in the space⁵². They can work around obstructions. These are first generation occupancy sensors and not very reliable as they get triggered by any movement including undesirable triggers. • <i>Passive Infrared Sensors (PIR)</i>, detect human body temperature by sending out infrared beams to detect temperature differences. These are an advancement on ultrasonic sensors. However, PIRs do not always work well in very hot climates, as the background temperature is like human body temperature. They also require a direct line of sight⁵³.

⁵² Source: <http://www.ecmweb.com/lighting-amp-control/occupancy-sensors-101>

⁵³ Source: [Occupancy Sensor Technologies](#) by Acuity Brands (2016)

ENERGY EFFICIENCY MEASURES IN EDGE

- *Microphonics sensors*, utilize a microphone inside of the sensor to hear sounds that indicate occupancy. They can learn to ignore background noise such as air conditioners and do not rely on line of sight. So they are especially useful in rooms with obstructions such as bathrooms with stalls.
- *Dual technology sensors*, use a combination of technologies described above to reduce the chances of false-on and false-off. As each type of presence-detecting technology has different limitations, many controls use a combination of the three technologies.

Daylight Sensors

Daylight sensors can be used to switch lights on or off, alone or in conjunction with dimmers. Daylight sensors sense the availability of daylight and can switch lights off or trigger lighting dimmers to produce reduced lighting levels to maintain a comfortable level of light.

Daylight Sensors

Natural light is amply available during daytime hours in most climates. Typically, just 1%-5% of the diffused exterior lighting available outside the building is sufficient to light up the interiors to the desired light levels. An intelligent daylight design has the following features:

- **Optimum glass area:** Windows need to be appropriately sized to allow sufficient diffused light into the space, without causing too much heat transfer. Especially in warm climates, a large amount of window area (above 40% window to wall ratio) may result in excessive cooling load, which may outweigh any benefits gained through daylighting control. Location and orientation of glass is also critical. South and North facing glass are more appropriate as they can be shaded easily and do not cause as much glare. Also, windows that are higher on the wall are more efficient in allowing diffused light deeper into the space.
- **Suitable sun shading:** Diffused sunlight is more desirable for daylighting. Direct sunlight should be avoided into regularly occupied spaces, as it causes glare and overheating. Windows on the south and north façades should be shaded with horizontal overhangs, whose depth is dictated by the latitude of the building location. In tropical countries, the required depth of horizontal shading is quite small. East and west windows should be avoided as much as possible. If provided, they should be equipped with vertical shading or full glass shading.
- **Appropriate glass product:** In climates where solar heat is undesirable, glass with low Solar Heat Gain Coefficient (SHGC) should be used. SHGC is the proportion of solar heat that the glass allows to pass through to the interior space. At the same time, care should be taken that the Visible Light Transmittance (VLT) of the product is not too low, as it will reduce the amount of usable light entering the space.
- **Automated daylight control system:** Energy is saved through daylighting only if the electric lights are switched off. It is desirable that the switching be done through automated controls to avoid missed opportunities. The two commonly used daylighting control types are Stepped and Continuous Dimming. A Stepped system turns off some lamps in the space when enough natural light is available by the photo sensor. A Continuous Dimming system dims down all lights to maintain the desirable light levels. Stepped controls are less expensive, while the Continuous

ENERGY EFFICIENCY MEASURES IN EDGE

Dimming system offers more savings. For both systems, the photo sensor should be appropriately located and calibrated to be effective.

Relationship to Other Measures

Lighting controls can reduce the amount of energy used by lighting in rooms, therefore the more efficient the light bulbs are, the less impact the automated controls will have. However, when using controls with energy efficient lighting, one should make sure to choose the correct light bulbs, which are not impacted by the increased switching or dimming.

As lighting controls help to reduce unnecessary use of lighting which produces heat, cooling loads are reduced. Both "Lighting" and "Cooling Energy" are reduced in the energy graph, while "Heating Energy" is increased.

The amount of savings achieved with a daylighting measure will be affected by the Window to Wall Ratio entered in the WWR measure.

Compliance Guidance

Design Stage	Post-Construction Stage
<p>At the design stage, the following must be used to demonstrate compliance:</p> <ul style="list-style-type: none">• Electrical layout drawings showing the location and type of all lighting controls; and• Lighting schedule listing the specifications for all controls, if applicable; and• Manufacturer's data sheets for the lighting controls.	<p>At the post-construction stage, the following must be used to demonstrate compliance:</p> <ul style="list-style-type: none">• Documents from the design stage if not already submitted. Include any updates made to the documents to clearly reflect As-Built conditions; and• Date-stamped photographs of the installed controls; it is not necessary to take photos of every single installed control, but the auditor is responsible for checking and verifying a reasonable proportion; or• Purchase receipts for the controls. <p>Existing building projects</p> <ul style="list-style-type: none">• If some of the documents required above are not available, other evidence of construction details, such as existing building drawings or photographs can be submitted.

EEM25 – SKYLIGHTS

Requirement Summary

This measure can be claimed if a building utilizes natural daylight from skylight(s) to light up the interior, reducing the use of artificial lighting during daytime hours. This measure is not available for all building types.

Intention

The intent of this measure is to reduce the use of electricity for artificial lighting by using natural daylight. The use of daylight for lighting interior spaces requires only a part of the roof to be transparent, and can save significant amounts of electricity usage for lighting, especially in spaces that are used mostly in the daytime.

Approach/Methodologies

The skylight(s) must be well distributed to provide maximum daylight penetration in the building. The skylight(s) may be horizontal or vertical (also called roof monitor).

To claim this measure, the design team must demonstrate that transparent elements in the roof allow sufficient daylight to achieve the required lighting level in the interior of the space of the top floor area, and that the lights in this area are equipped with dimming or shut-off controls such as daylight-responsive controls.

The “Daylight Zone” claimed under each type of skylight must comply with the guidelines accompanied by the figures below.

1. The Daylight Zone of a skylight shall extend in both horizontal directions along the floor beyond the edge of the skylight to the lesser of (i) 0.7 x the ceiling height, or (ii) the nearest obstruction that is 0.7 times the ceiling height or more, as indicated in **Figure 25**.
 - a. An obstruction *less* than 0.7 x the ceiling height (CH) may be ignored
 - b. An obstruction up to 0.7 x CH in height that is *closer* than 0.7 x (CH minus the obstruction height (OH)) may be ignored⁵⁴
 2. In the case of multiple skylights, the floor areas under the skylights which are being counted as Daylight Zone areas must not overlap.
 3. The lighting in each Daylight Zone area must be controlled with either manual or daylight-responsive controls. Controls or calibration mechanisms must be readily accessible, and may serve all light fixtures, alternate fixtures or individual fixtures in a zone. Dimmable controls must be capable of dimming to 15% of light output or lower and be capable of complete shut-off.
- Exceptions:
- a. Areas with less than 6.5 Watts/m² of general lighting may not be controlled
 - b. Areas designated as security or emergency areas that are required to be continuously lighted
 - c. Interior exit stairways, interior exit ramps and exit passageways

⁵⁴ Adapted from: (1) ASHRAE Standard 90.1-2015 and (2) International Energy Conservation Code 2015, Section C405.2 Lighting Controls

ENERGY EFFICIENCY MEASURES IN EDGE

- d. Emergency egress lighting that is normally off
- e. Display/accent lighting must have dedicated controls independent of the general lighting controls

Design Guidance

Sunlight access must not be blocked for > 1500 hours in a year between 8 a.m. and 4 p.m.

One method to verify the adequacy of the daylighting system is to calculate the product of the visible transmittance (VT) of the skylight and the area of the skylight (rough opening), divided by the area of the Daylight Zone. The result must be no less than 0.008.

$$VT \times \frac{\text{Area of Skylight}}{\text{Area of Daylight Zone}} \geq 0.008$$

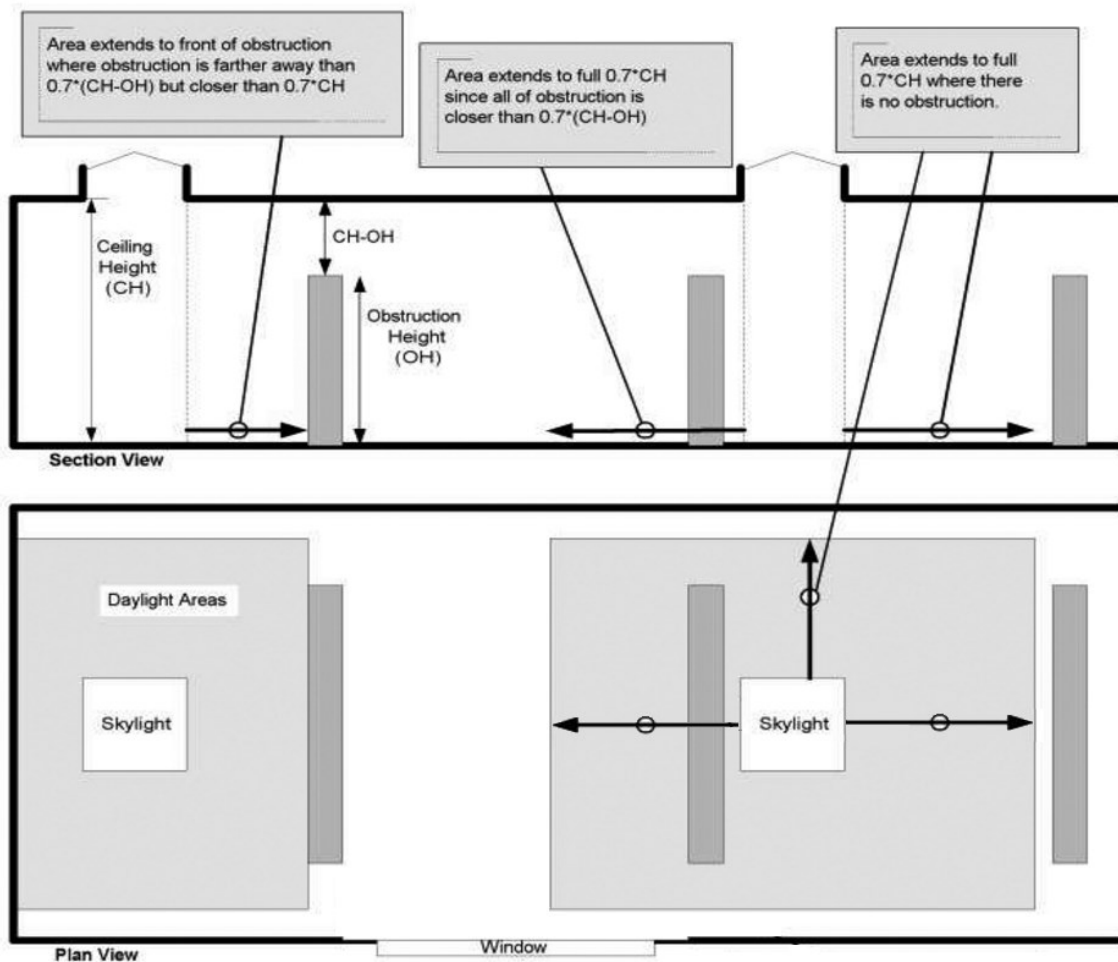
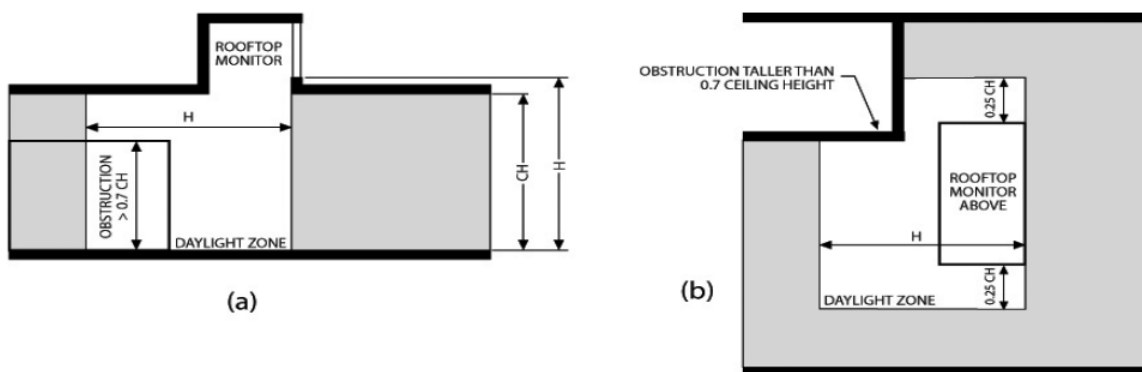

Figure 25. Daylight zone under roof skylights

ENERGY EFFICIENCY MEASURES IN EDGE



(a) Section view and (b) Plan view of daylight zone under a rooftop monitor

Figure 26. Daylight zone under a vertical skylight (roof monitor) with a flat top

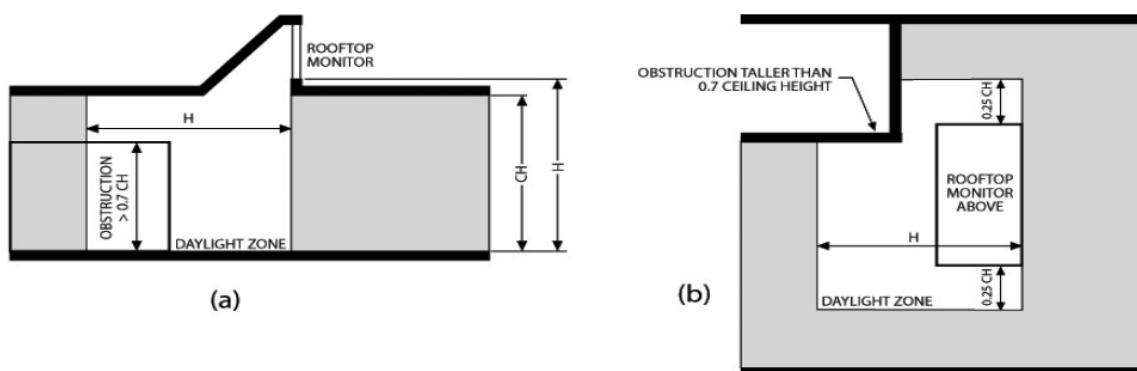

(a) Section view and (b) Plan view of daylight zone under a rooftop monitor

Figure 27. Daylight zone under a vertical skylight (roof monitor) with a sloping top

The base case assumes no skylights in the building. When this measure is selected, the improved case with skylights assumes that a default area of 50% of the top floor is a Daylight Zone served by skylights, with a default Solar Heat Gain Coefficient (SHGC) of 0.35 and a U-value of 1.7 W/m².K. Selecting the measure also reveals the editable fields for (1) the area of the Daylight Zone (represented as a percentage of the top floor area) labelled as "% Day Lit Area," (2) SHGC of the fenestration, and (3) U-value of the fenestration.

Potential Technologies/Strategies

Natural daylight can be introduced into the building using windows in the roof, that is, skylights. Glass skylights are typically used, but daylight can also be introduced through other transparent or translucent materials such as transparent plastic panels or translucent insulation panels.

ENERGY EFFICIENCY MEASURES IN EDGE

Relationship to Other Measures

Besides impacting the use of artificial lighting, the use of skylights will impact the heat gain through a roof which will impact the energy use for space conditioning. The area of skylights and their thermal properties (Solar Heat Gain Coefficient or SHGC and U-value) must be optimized to avoid excessive heat gain. Reduction in electricity usage for artificial lighting by using skylights must be balanced with the potential increase in cooling energy use.

Compliance Guidance

Design Stage	Post-Construction Stage
<p>At the design stage, the following must be used to demonstrate compliance:</p> <ul style="list-style-type: none">• Building plans and sections showing the Daylight Zones with the location and size of skylight(s) and any obstructions; and• Manufacturer's data sheets showing the seasonal average U-value for the skylight (including glass and frame) and the solar heat gain coefficient (SHGC) of the glass and frame types; and• Lighting plans showing the photosensitive lighting controls in the Daylight Zones.	<p>At the post-construction stage, the following must be used to demonstrate compliance:</p> <ul style="list-style-type: none">• Documents from the design stage if not already submitted. Include any updates made to the documents to clearly reflect As-Built conditions; and• Date-stamped photographs of the installed skylights and associated photosensitive lighting controls; or• Purchase receipts for the skylights and associated photosensitive lighting controls. <p>Existing building projects</p> <ul style="list-style-type: none">• If some of the documents required above are not available, other evidence of construction details, such as existing building drawings or photographs can be submitted.

EEM26 – DEMAND CONTROL VENTILATION FOR PARKING USING CO SENSORS

Requirement Summary

Mechanical ventilation in indoor parking areas can be controlled by CO sensors. At least 50% of the parking ventilation system should be controlled by CO sensors to claim this measure.

Intention

Mechanical ventilation introduces fresh air into the space. By installing CO sensors in at least 50% of the parking areas, mechanical ventilation can be switched off when it is not required, thus consuming lesser energy. While the primary benefit of the CO sensors is the reduction of energy bills, the following are the other associated benefits:

- Improved indoor air quality
- Occupant comfort
- Reduced greenhouse gas emissions; and
- Extended equipment life due to less demand on the HVAC system

It is recommended that the control system take frequent measurements of CO levels to adjust the ventilation supply to maintain proper indoor air quality.

Approach/Methodologies

No calculations are involved in the assessment of this measure. The improved case assumes that CO sensors are installed on fresh air systems to control the fresh air based on the demand. To claim that this measure has been achieved, the project team must demonstrate that the indoor parking areas have CO sensors to control ventilation, covering at least 50% of the building floor area.

The base case assumption is that the mechanical ventilation in the parking area is provided at a fixed rate.

Potential Technologies/Strategies

The amount of mechanical ventilation can be controlled to only provide fresh air to spaces at the time that it is required. This reduces the energy consumed by the HVAC system. Traditional ventilation systems are designed to provide a constant volume of fresh air based on maximum occupancy⁵⁵. However, at partial occupancy levels, energy is wasted to condition outside air provided through the mechanical ventilation system even when it is

⁵⁵ Commercial HVAC, Manitoba Hydro. 2014. https://www.hydro.mb.ca/your_business/hvac/ventilation_co2_sensor.shtml

ENERGY EFFICIENCY MEASURES IN EDGE

not needed. The level of Carbon Monoxide (CO) in the air serves as a useful indicator of the parking area's air quality, and therefore its ventilation needs.

CO sensors are therefore a type of controls based on demand for the mechanical ventilation system, which reduce energy consumption while ensuring good air quality. The savings vary depending on the configuration of the HVAC system. For constant volume air-handling units (AHUs), the savings occur at the primary systems (boilers, chillers, air-conditioners, etc.), while for variable-air-volume (VAV) AHUs, the savings occur not only at the primary systems but also at the terminal boxes that include reheat⁵⁶. The following image explains the way CO sensors operate in both cases:

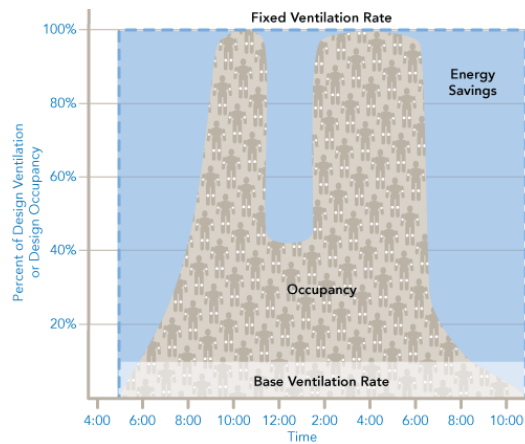

Figure 28. Energy savings due to CO sensors (extrapolated from CO₂ sensors) Source²³

ASHRAE Standard 90.1-2004 recommends that the building incorporate any type of Demand Controlled Ventilation (DCV), which includes CO sensors, when the building has a density greater than 100 people and when the AHU has an outdoor air capacity greater than 3,000 ft³/min. The following specifications are recommended in ASHRAE 90.1-2004 for the selection of the CO sensor:

- Range: 0-2,000 ppm
- Accuracy (including repeatability, non-linearity and calibration uncertainty): +/- 50 ppm
- Stability (allowed error due to aging): <5% Full Scale for 5 years
- Linearity (maximum deviation between a reading and the sensor's calibration curve): +/- 2% Full Scale
- Manufacturer recommended minimum calibration frequency: 5 years

Relationship to Other Measures

CO sensors are controls for the mechanical ventilation system that can reduce the amount of cooling or heating energy, as well as fan energy, used by the HVAC system as less outside air is moved into the indoor parking area. In addition, if the building uses a water-cooled chiller for the AC, then a reduction in the water consumption is also achieved.

⁵⁶ Design brief: Demand-controlled ventilation, Energy Design Resources. 2007. http://energydesignresources.com/media/1705/EDR_DesignBriefs_demandcontrolledventilation.pdf?tracked=true

ENERGY EFFICIENCY MEASURES IN EDGE

Compliance Guidance

Design Stage	Post-Construction Stage
<p>At the design stage, the following must be used to demonstrate compliance:</p> <ul style="list-style-type: none">• HVAC layout drawings showing the location of the CO sensors for the parking ventilation system including the mounting height; and• Manufacturer specifications of the sensors.	<p>At the post-construction stage, the following must be used to demonstrate compliance:</p> <ul style="list-style-type: none">• Documents from the design stage if not already submitted. Include any updates made to the documents to clearly reflect As-Built conditions; and• Date-stamped photographs of the CO sensors taken during or after installation showing the make and model; or• Purchase receipts for the CO sensors showing the make and model. <p>Existing building projects</p> <ul style="list-style-type: none">• If some of the documents required above are not available, other evidence of construction details, such as existing building drawings or photographs can be submitted.

ENERGY EFFICIENCY MEASURES IN EDGE

EEM27* – INSULATION FOR COLD STORAGE ENVELOPE

Requirement Summary

The actual U-values of the respective elements should be entered in the software in the Energy tab. For multiple element types with different U-values, use an area-weighted average. Note that for exterior walls or roofs with insulation, the measure for 'Wall Insulation' or 'Roof Insulation' should also be selected in the Materials tab, and the actual insulation type and thickness entered.

The U-value indicates the thermal performance of these elements of the building:

- Exterior walls
- Internal walls
- Floor slabs
- Roof slabs, and
- Window Glass

Intention, Approach/Methodologies, Potential Technologies/Strategies, Relationship to Other Measures

For details on the above, see similar measure descriptions for Insulated walls, Roofs, Low-e coated glass, and High-performance glass previously described in this user guide.

ENERGY EFFICIENCY MEASURES IN EDGE

Compliance Guidance

This measure has several components. To claim any component of this measure, it is necessary to demonstrate that the U-value of that component is better (lower) than the Base Case. If the EDGE default for the improved case U-value is used, then it is only necessary to demonstrate that that component has been or will be installed, and that the U-value of the component does not exceed the base case.

If a user-input U-value exceeds the default improved case value, then it is necessary to confirm that the U-value has been calculated in accordance with the "simple" or "combined" method as previously described in the Approach/Methodologies of related glass and wall measures above.

Design Stage	Post-Construction Stage
<p>At the design stage, the following must be used to demonstrate compliance:</p> <ul style="list-style-type: none">• Plans of the cold storage space highlighting the envelope elements -- types of wall, floor slab, roof, and glass; and• Detailed drawing(s) showing the materials used in the envelope with U-value specifications; and• Calculations of U-value for each element; and• Manufacturer's data sheets for the specified insulation and glass showing the brand and product name and insulating properties.	<p>At the post-construction stage, the following must be used to demonstrate compliance:</p> <ul style="list-style-type: none">• Documents from the design stage if not already submitted. Include any updates made to the documents to clearly reflect As-Built conditions; and• Date-stamped photographs of the envelope elements taken during construction at a point when any insulation materials claimed were visible on site; or• Purchase receipts showing the installed products. <p>Existing building projects</p> <ul style="list-style-type: none">• If the documents required above are not available, other evidence of construction details, such as existing building drawings or photographs can be submitted.

ENERGY EFFICIENCY MEASURES IN EDGE

EEM28 – EFFICIENT REFRIGERATION FOR COLD STORAGE

Requirement Summary

This measure can be claimed if the refrigerated cases, and any other fridge or refrigerator installed are energy efficient. This can be demonstrated by purchasing refrigerated cases, fridges and refrigerators that achieve recognized appliance ratings as described in the Approach/Methodologies section (below).

Intention

Minimize the energy consumed by refrigeration equipment installed in the buildings, such as supermarkets and small food retail, to reduce the operational costs and increase the reputation of the retailer.

Approach/Methodologies

EDGE uses the following recognized appliance rating systems, but is not limited to:

- Energy Star rated - Commercial Food Service (CFS) equipment, which are up to 40% more efficient than standard ones; or
- Minimum 'A' rating under the EU Energy Efficiency Labelling Scheme ⁵⁷; which will be mandatory in 2016 for commercial refrigeration cabinets (draft versions are currently available); or
- Listed in the Energy Technology Product List (ETL)⁵⁸; or
- Equivalent level in a comparable rating scheme ⁵⁹ to the ones above.

The energy chart shows reduction in 'Refrigeration'.

The base case assumes standard refrigerated cases. The improved case is 10% more efficient. The reduction varies depending on the type of building.

Potential Technologies/Strategies

Refrigerated cases are mostly used in supermarkets and small food retail, where up to half of the energy consumption is dedicated to the refrigeration systems (display cases and storage coolers). Four main categories of refrigerated cases are shown in the table below:

⁵⁷ The scheme will be launched in July 2016. Draft versions can be used

⁵⁸ Energy Technology List (ETL) is the UK government-managed list of energy-efficient plant and machinery. ETL website: <https://etl.decc.gov.uk/etl/site/etl.html>

⁵⁹ If other rating schemes are used, evidence describing how the refrigerated cases, fridges and refrigerators meets or exceeds the equivalent requirements under the Energy Star or EU labelling scheme or ETL list must be submitted.

ENERGY EFFICIENCY MEASURES IN EDGE

Table 39: Types of refrigerated cases

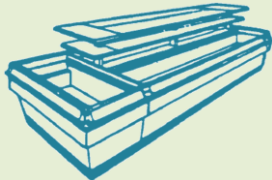
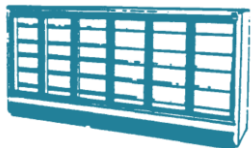
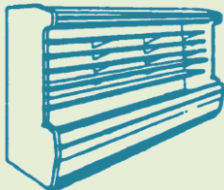
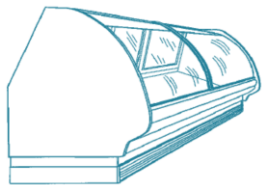
Type of refrigerated cases	Use	Key Features for Efficiency
Tub or Island 	Storage and display of frozen foods and meats.	<ul style="list-style-type: none"> Operate at a very uniform temperature and less amount of refrigeration per unit area. It has low storage volume per unit area used.
Glass door reach-in 	Supermarkets, primarily for frozen foods	<ul style="list-style-type: none"> Ability to contain the cold refrigerated air, which reduces the “cold aisle” problem. Less refrigeration loads. EEMs for this type are anti-sweat heaters in the doors to prevent fogging and decreased visibility of the product.
Open-front multi-deck 		<ul style="list-style-type: none"> Possesses the largest storage volume per unit area, because of the use of an upright cabinet and shelves. high Refrigeration requirements for multi-deck cases, including latent load from ambient air. Recommended EEMs for this type are air curtains.
Single-deck or service 	Display of fresh meat products.	<ul style="list-style-type: none"> Equipped with sliding doors in the back for the staff and a glass front to show the products to customers. Commonly seen in the deli and meat departments of supermarkets.

The energy use of the cases described above is related to the refrigeration load, the sources of which are:

- **Infiltration:** Moist and warm air from the ambient pass through the open front of the cases. Energy efficiency measures (EEMs) include air curtains or glass doors, which are detailed in **Table 40**;
- **Conduction:** Case panels and walls allow heat to be conducted to the interior of the case;
- **Thermal radiation** from the ambient surfaces to the product and display case interior; and
- **Internal heat gains:** generated by the lights, evaporator fans, periodic defrosts, and anti-sweat heaters.

To reduce this load various energy efficiency measures (EEMs) could be applied to the refrigerated cases, which result in the reduction of the refrigeration load and therefore energy savings of the retail units. These EEMs are explained in the table below:

ENERGY EFFICIENCY MEASURES IN EDGE

Table 40: Efficiency measures for Refrigerated cases

Technologies / controls	Potential saving (refrigeration) energy ⁶⁰	Application	Benefits /Key Features for Efficiency ⁶¹
Glass doors	Up to 50%	<ul style="list-style-type: none"> Chilled and frozen multi-decks 	<ul style="list-style-type: none"> Better performance to medium temperature cases. Special Polymer doors reduce the need for thermal glass.
Strip Curtains and Air curtains	30%	<ul style="list-style-type: none"> Chilled multi-decks Well freezers 	<ul style="list-style-type: none"> Reduced infiltration of ambient air and humidity into the display case.
Night blinds or night covers	20%	<ul style="list-style-type: none"> Chilled multi-decks Well freezers 	<ul style="list-style-type: none"> Out-of-hours usage to reduce heat gain from ambient temperature
Multideck Air Curtain Optimization Technology	17%	<ul style="list-style-type: none"> Chilled multi-decks 	<ul style="list-style-type: none"> Cost savings from reduced energy consumption Low cost and fast payback within two years Easy to install and minimal maintenance Warmer shopping aisles for improved consumer experience
Defrost optimization	20%	<ul style="list-style-type: none"> Freezers 	<ul style="list-style-type: none"> Need of defrost controls that triggers defrost only when needed
Interior Lighting	5 - 12%	<ul style="list-style-type: none"> All types 	<ul style="list-style-type: none"> Energy-efficient lights: LED lighting or T8 lamps Electronic Ballasts
Efficient Modular / Multi Evaporator coil	10%	<ul style="list-style-type: none"> All cabinets Mainly freezers 	<ul style="list-style-type: none"> Defrost system to be installed with multi-evaporator Enhance heat transfer Evaporator coil to operate at a close temperature difference (TD). Efficient coil: evaporation occurs over the greatest length of coil tubing, which maintains a reasonable evaporator size. Use of electronic expansion valves.
High efficiency compressors and fans (evaporator or motors)	9%	<ul style="list-style-type: none"> All cabinets with forced air convection 	<ul style="list-style-type: none"> Reduce both refrigeration load and direct energy consumption, as coil defrost is less needed. Use of electronically commutated motor (ECM) Use of variable-speed drive (VSD), which enables the coil to be held constant throughout the time between defrosts, and to reduce defrost time/cycle.
Electronic Commutated Motors (ECM)	2 - 8 %	<ul style="list-style-type: none"> Evaporator: All cabinets with forced air convection Condenser: All integrals and remote system 	<ul style="list-style-type: none"> 2% for reach-in freezers 7% for reach-in refrigerators 8% for (grocery) display cases
Thicker Insulation	4 - 6%	<ul style="list-style-type: none"> All - primarily frozen 	<ul style="list-style-type: none"> Insulation such as Vacuum Insulated Panels (VIPs) helps cut conduction heating of the cases.
Non-electric Anti-sweat heater controls	3 - 6%	<ul style="list-style-type: none"> Freezers cabinets 	<ul style="list-style-type: none"> Reduce energy consumption as load is decreased.
High efficiency Liquid Suction Heat Exchanger (LSHX)	3%	<ul style="list-style-type: none"> All cabinets 	<ul style="list-style-type: none"> Provides sub-cooling of liquid refrigerant through useful superheat. Allows the evaporator coil to operate with low superheat at the evaporator outlet.

⁶⁰ Potential supermarket energy efficiency options

⁶¹ Investigation of Energy-Efficient Supermarket Display Cases. December, 2004. Prepared by: Foster Miller, Inc. David H. Walker Principal Investigator Southern California Edison RTTC. Ramin T. Faramarzi Principal Investigator Oak Ridge National Lab Van D. Baxter

ENERGY EFFICIENCY MEASURES IN EDGE

Technologies / controls	Potential saving (refrigeration) energy ⁶⁰	Application	Benefits /Key Features for Efficiency ⁶¹
Tangential fan	2%	<ul style="list-style-type: none"> All cabinets with fans 	<ul style="list-style-type: none"> Improve the coil airflow distribution. For increased savings to be used ECM motor and VSD controller
Low-E / reflective glazing (K glass)	1 - 2%	<ul style="list-style-type: none"> Glazed and delicatessen cabinets 	<ul style="list-style-type: none"> Reduction on radiant heat

The way the occupants / building manager use the appliances also influences energy performance. It is important to provide users with guidelines outlining the benefits of these appliances, and the best way to achieve maximum efficiency.

Relationship to Other Measures

Claiming this measure reduces energy use for refrigeration only.

Compliance Guidance

Design Stage	Post-Construction Stage
<p>At the design stage, the following must be used to demonstrate compliance:</p> <ul style="list-style-type: none"> Summary list of the refrigerated cases to be installed in the building, including quantity, energy use, and proof of certification by <i>Energy Star</i>, <i>EU Energy Efficiency Labeling Scheme</i>, <i>Energy Technology Product List (ETL)</i>, or equivalent; and Manufacturer's specifications of the refrigerators/freezers. 	<p>At the post-construction stage, the following must be used to demonstrate compliance:</p> <ul style="list-style-type: none"> Documents from the design stage if not already submitted. Include any updates made to the documents to clearly reflect As-Built conditions; and Date-stamped photographs of the installed refrigerators/freezers showing the make and model; or Purchase receipts for the refrigerators/freezers showing the make and model. <p>Existing building projects</p> <ul style="list-style-type: none"> If some of the documents required above are not available, other evidence of construction details, such as existing building drawings or photographs can be submitted.

ENERGY EFFICIENCY MEASURES IN EDGE

EEM29 – EFFICIENT REFRIGERATORS AND CLOTHES WASHING MACHINES

Requirement Summary

This measure can be claimed if the refrigerators and clothes washing machines installed are energy efficient. This can be demonstrated by purchasing refrigerators and clothes washing machines that achieve recognized appliance ratings as described in the Approach/Methodologies section below. This measure cannot be claimed if homes are not fitted with efficient refrigerators and clothes washing machines at the time of certification, and there is no binding agreement in place to ensure that they will be installed later.

Intention

Minimize the energy consumed by refrigerators and clothes washing machines installed in a home.

Approach/Methodologies

EDGE uses the following recognized appliance rating systems, but is not necessarily limited to:



- Energy Star rated; or
- Minimum 'A' rating under the EU Energy Efficiency Labelling Scheme; or
- Equivalent level in a comparable rating scheme⁶² to the ones above

The base case assumes standard refrigerators and clothes washing machines, while the improved case is 5% to 10% more efficient.

⁶² If other rating schemes are used, evidence describing how the refrigerator or clothes washing machine meets or exceeds the equivalent requirements under the Energy Star or EU labelling scheme must be submitted.

ENERGY EFFICIENCY MEASURES IN EDGE

Potential Technologies/Strategies

Appliance	Overview	Key Features for Efficiency
<p>Refrigerators</p> 	<p>After heating and cooling, refrigeration appliances are the biggest energy consumption in a household, as they are working continuously.</p>	<p>An efficient refrigerator should:</p> <ul style="list-style-type: none"> • Be small. Consider refrigerators with a capacity of 14 to 20 cubic feet (>4 people). • Have a high efficiency compressor (350kWh/year or less). • A model with the freezer on top (not a bottom-mounted freezer or side-by-side model). • Not have an automatic ice-maker and/or through-the-door ice dispenser. • Have automatic moisture control rather than an "anti-sweat" heater.
<p>Clothes Washing Machines</p> 	<p>About 60% of the energy used by a washing machine goes towards water heating; therefore, models that use less water also use less energy.</p>	<p>An efficient clothes washing machine should:</p> <ul style="list-style-type: none"> • Be the right size for the house. • Have several wash cycles. • Have improved water filtration. • Have a dryer with a moisture sensor. • Have a model with a high Modified Energy Factor (MEF) and a low Water Factor (WF).

The way the occupants use the appliances also influences energy performance. It is important to provide users with guidelines outlining the benefits of these appliances, and the best way to achieve maximum efficiency.

Relationship to Other Measures

Energy reduction due to appliances is expected by both energy efficient refrigerators and clothes washing machines. Clothes washing machines also show reductions in energy due to hot water as well as lower water consumption.

ENERGY EFFICIENCY MEASURES IN EDGE

Compliance Guidance

Design Stage	Post-Construction Stage
<p>At the design stage, the following must be used to demonstrate compliance:</p> <ul style="list-style-type: none">• Summary list of the refrigerators and clothes washing machines to be installed in the building, including quantity, energy use, and proof of certification by <i>Energy Star</i>, <i>EU Energy Efficiency Labeling Scheme</i>, <i>Energy Technology Product List (ETL)</i>, or equivalent; and• Manufacturer's specifications of the refrigerators and clothes washing machines.	<p>At the post-construction stage, the following must be used to demonstrate compliance:</p> <ul style="list-style-type: none">• Documents from the design stage if not already submitted. Include any updates made to the documents to clearly reflect As-Built conditions; and• Date-stamped photographs of the installed refrigerators and clothes washing machines showing the make and model; or• Purchase receipts for the refrigerators and clothes washing machines showing the make and model. <p>Existing building projects</p> <ul style="list-style-type: none">• If some of the documents required above are not available, other evidence of construction details, such as existing building drawings or photographs can be submitted.

ENERGY EFFICIENCY MEASURES IN EDGE

EEM30 – SUBMETERS FOR HEATING AND/OR COOLING SYSTEMS

Requirement Summary

To claim this measure, the project must demonstrate that dedicated meters for the heating and cooling systems have been installed.

Intention

The intent is to reduce the energy used for space conditioning by increasing the awareness of it. Studies have shown that benchmarking energy use can reduce energy consumption by 2-3%⁶³.

Approach/Methodologies

EDGE assumes that installing submeters reduces the associated heating or cooling system energy use by 1%.

The Base Case assumes that no submeters are installed. The Improved Case assumes 1% savings in the category — Heating, Cooling, or both — for which submeters are installed.

Potential Technologies/Strategies

Installing submeters on individual pieces of equipment or electrical circuits is a simple and standard process.

Relationship to Other Measures

This measure does not interact with other measures.

⁶³ <https://www.imt.org/epa-analysis-shows-big-benchmarking-savings/> and https://www.energystar.gov/sites/default/files/buildings/tools/DataTrends_Savings_20121002.pdf

ENERGY EFFICIENCY MEASURES IN EDGE

Compliance Guidance

Design Stage	Post-Construction Stage
<p>At the design stage, the following must be used to demonstrate compliance:</p> <ul style="list-style-type: none"> • Electrical drawings/specifications showing the make and model of the electricity meters and the connection with the mains; and • Manufacturer’s data sheets of the meters; or • Technical specifications for an equivalent online system. 	<p>At the post-construction stage, the following must be used to demonstrate compliance:</p> <ul style="list-style-type: none"> • Documents from the design stage if not already submitted. Include any updates made to the documents to clearly reflect As-Built conditions; and • Date-stamped photographs of the installed meters showing the make and model; or • Purchase receipts for the meters showing the make and model; or • Purchase receipts for subscription(s) to an equivalent online system. <p>Existing building projects</p> <ul style="list-style-type: none"> • If some of the documents required above are not available, other evidence of construction details, such as existing building drawings or photographs can be submitted.

ENERGY EFFICIENCY MEASURES IN EDGE

EEM31 – SMART METERS FOR ENERGY

Requirement Summary

This measure can be claimed when smart metering is provided in each unit of the building. The owners may subscribe to an online monitoring system or install a Home Electricity Management System (HEMS), which requires little additional equipment installation. Note that this measure cannot be claimed when 'prepaid meters' are installed as they are not considered smart meters under EDGE.

The smart meter must be able to show readings of the last hour, last day, last 7 days and last 12 months of usage data, and the devices should be accessible within the home. Other objectives of the smart meters and / or HEMS are:

- Measure home electricity use and real power;
- Analyze measurements;
- Relatively low price per home;
- The smart meters solution must be workable in offline households with no web dependency.

Intention

The intent is to reduce energy demand through increased awareness of energy consumption. With smart meters, end-users can appreciate, understand, and contribute to responsible use of energy in the building. Smart meters can display measurements and recommendations.

Approach/Methodologies

When smart meters are installed in each unit of the building, end-users receive immediate feedback that can result in 10 to 20% energy savings, as they are able to identify consumption in more detail than with conventional meters.

The base case assumes conventional meters, while the improved case assumes smart meters to be installed in each unit.

Potential Technologies/Strategies

Smart metering is designed to provide occupants with information on a real-time basis about their domestic energy consumption. This may include data on how much gas and electricity they are consuming, the costs, and the impact of their consumption on greenhouse gas emissions.

A detection unit (the transmitter) is affixed to an existing utility meter and tracks energy use. The display unit receives a wireless signal from the transmitter and displays the consumption information in real time and cost

ENERGY EFFICIENCY MEASURES IN EDGE

for the end user. Many companies also offer online monitoring systems⁶⁴ which require little to no additional equipment installation.

The benefits of smart metering include controlling demand; improving equipment performance by signaling the need for preventive maintenance or repairs; optimizing operational efficiency with controlled costs; and maximizing property values.

For best results it is recommended that separate smart meters be used for different uses, i.e. lighting, cooling, heating, hot water, and plug loads. This will offer better visibility of energy usage and therefore better management. Some design considerations for an optimal HEMS are as follows:

- Include a utility-grade power meter, with network interface to home broadband router, or access to cloud based data analysis, as an option;
- Consider an inductive power meter (clamp-on sensor) with wireless Home Area Network (HAN) connection to in-home display (IHD) or web browser; and
- Use an interface to utility electricity meter for data acquisition, data storage in logger device, HAN connection to IHD or web browser.

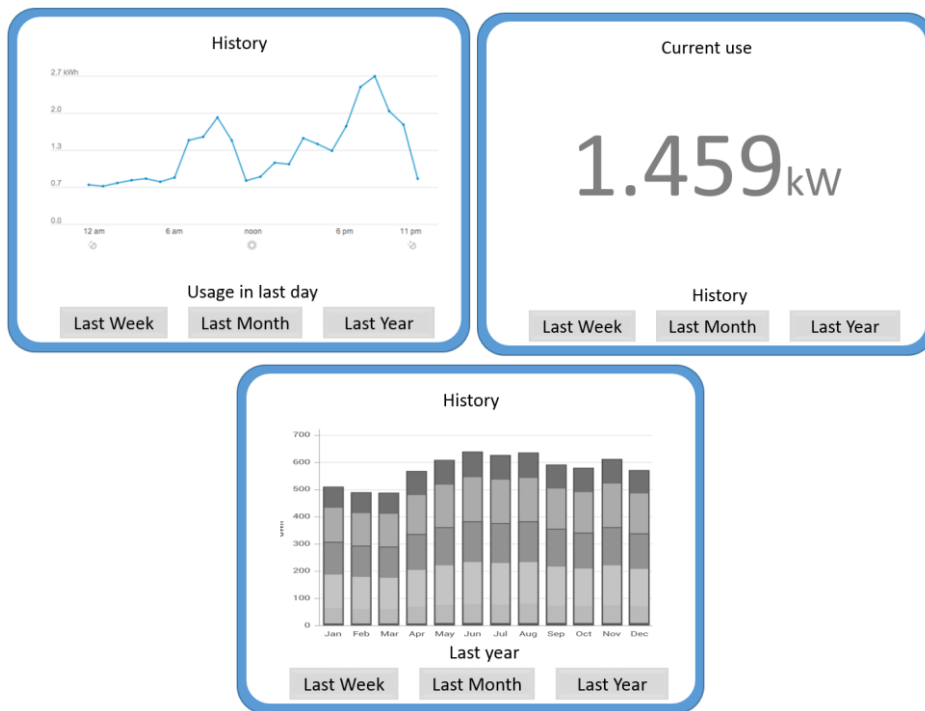

Figure 29. Home screen to of smart meter with display options to inform home users

⁶⁴ For example, <http://www.theenergydetective.com/> or http://efergy.com/media/download/datasheets/ecotouch_uk_datashet_web2011.pdf

ENERGY EFFICIENCY MEASURES IN EDGE

Relationship to Other Measures

The contribution made by the measure is reflected in the common amenities portion of the energy chart. Although EDGE does not show savings in other areas of energy consumption, this measure increases end user awareness, which in the long term can help to significantly reduce energy consumption from appliances, heating, cooling, and hot water.

Compliance Guidance

Design Stage	Post-Construction Stage
<p>At the design stage, the following must be used to demonstrate compliance:</p> <ul style="list-style-type: none">• Electric drawings/specifications showing the make and model of the smart energy meters and the connection with the electric system; and• Manufacturer’s data sheets of the meters; or• Technical specifications for an equivalent online system.	<p>At the post-construction stage, the following must be used to demonstrate compliance:</p> <ul style="list-style-type: none">• Documents from the design stage if not already submitted. Include any updates made to the documents to clearly reflect As-Built conditions; and• Date-stamped photographs of the installed meters showing the make and model; or• Purchase receipts for the meters showing the make and model; or• Purchase receipts for subscription(s) to an equivalent online system. <p>Existing building projects</p> <ul style="list-style-type: none">• If some of the documents required above are not available, other evidence of construction details, such as existing building drawings or photographs can be submitted.

ENERGY EFFICIENCY MEASURES IN EDGE

EEM32 – POWER FACTOR CORRECTIONS

Requirement Summary

This measure can be claimed when power factor correction devices, such as voltage stabilizers, are installed on the incoming current into the building.

Intention

The intent of this measure is to improve the quality of the power being delivered to the equipment, thus improving their efficiency and output.

Approach/Methodologies

EDGE assumes that power correction devices improve the performance of the electrical equipment by improving the quality of power delivered.

Potential Technologies/Strategies

Several types of power correction devices are available⁶⁵. These include:

- Voltage Regulators
- Isolation Transformers
- Noise Filters
- Power Line Conditioners
- Harmonic Current Solutions, and
- Uninterrupted Power Supplies (UPS)

Relationship to Other Measures

This measure does not impact other measures in EDGE.

⁶⁵ <https://electrical-engineering-portal.com/power-correction-devices>

ENERGY EFFICIENCY MEASURES IN EDGE

Compliance Guidance

Design Stage	Post-Construction Stage
<p>At the design stage, the following must be used to demonstrate compliance:</p> <ul style="list-style-type: none">• Electrical drawings/specifications including the make and model of the power factor correction devices; and• Manufacturer’s specifications of the power correction devices.	<p>At the post-construction stage, the following must be used to demonstrate compliance:</p> <ul style="list-style-type: none">• Documents from the design stage if not already submitted. Include any updates made to the documents to clearly reflect As-Built conditions; and• Date-stamped photographs of the installed power factor correction devices showing the make and model; or• Purchase receipts for the power factor correction devices showing the make and model. <p>Existing building projects</p> <ul style="list-style-type: none">• If some of the documents required above are not available, other evidence of construction details, such as existing building drawings or photographs can be submitted.

ENERGY EFFICIENCY MEASURES IN EDGE

EEM33 – ONSITE RENEWABLE ENERGY

Requirement Summary

This measure can be claimed if a renewable source — such as solar photovoltaic (PV) panels, Wind, or Biomass — is used to displace fossil-fuel-based energy and if the energy generated from it is used for operation of the building. The renewable energy source must be located on the project site — installed on the building or the site — to claim savings.

Intention

The intent of this measure is to reduce the use of electricity generated from fossil fuels such as coal. The use of renewable energy reduces the combustion of fossil fuels to produce energy and the resulting emissions. For example, installing solar photovoltaic panels reduces the amount of electricity required from the grid. Because the renewable source replaces a proportion of the electricity generated from fossil fuels, renewable sources of electricity are considered an energy efficiency measure.

Approach/Methodologies

To claim this measure, the design team needs to indicate the percentage of electricity demand offset with renewable energy generated on-site, expressed as a percentage of the annual electricity use (kWh/year) of the improved case that is met by the renewable system. The inputs can be accessed from the Detailed entry under the Options Menu.

The total annual electricity consumption of the improved case is calculated automatically by EDGE. The design team must be able to demonstrate that the renewable electricity source can deliver the percentage of electricity consumption claimed by the project.

For example, in the case of a Solar PV system, if the projected energy use for the improved case is 100 kWh/m²/year, and the PV system will generate 10 kWh/m²/year, 10% must be input into the model. The expected output of the solar panels is measured in kilowatt peak (kWp) and is based on the theoretical peak output of the panels under test conditions. The kWp can be obtained directly from the manufacturer.

The renewable electricity source may be centralized for a combination of buildings/dwellings within the development. In these cases, the renewable energy generation must be located within the site boundary of the project or managed by a company within the control of the site owner. This is to ensure continued and sustainable management and access to the plant for future maintenance.

For any project being split into multiple EDGE models, a total value must be calculated for the entire project and this value must be input into every model.

When the renewable energy generation is located off-site, a contract with the management company in charge of the PV system must be provided as part of the documentation at the post-construction stage.

ENERGY EFFICIENCY MEASURES IN EDGE

Potential Technologies/Strategies

Several systems for generating electricity from renewable sources are available at varying levels of efficiency. Efficiency levels of 20% or more can be achieved by some commercially available systems, but others are only capable of delivering as little as 5% efficiency. Design teams must therefore ensure that the specified system achieves the maximum efficiency possible for the available capital.

Solar PV Panels

Many types of solar photovoltaic systems are available and different technologies convert solar energy into electricity with varying levels of efficiency. Efficiency levels of up to 22.5% can be achieved by some commercially available systems, but others are only capable of delivering as little as 5% efficiency. Most panels range from 14% to 16% efficiency rating⁶⁶. Design teams should therefore ensure that the specified system achieves the maximum efficiency possible for the available capital.

Wind Turbine

Small wind turbines of ranging in size from 400 watts to 20 kilowatts can be operated on buildings in suitable locations with sufficient wind speeds and local codes that allow wind turbines to be installed locally.

Biomass

Biomass can take many forms – from plants and wood, to animal and agricultural waste⁶⁷. A collective term for all plant and animal material, biomass is considered a renewable energy resource because plants can be grown and harvested in shorter cycles, and plant and food waste is constantly being produced, as compared to the finite nature of fossil fuels. In power generation it is commonly used as wood pellets that are harvested from forests and burned to release energy. Biomass can also be used more indirectly, by converting organic material into biofuels that can be used as alternative energy carriers to traditional fuels like diesel or petroleum.

The use of biomass is controversial because it is still a fuel that releases emissions, and large forested areas often need to be removed to produce feedstock. The entire supply chain of a biofuel must be considered in determining whether it is indeed carbon neutral/carbon negative. Because of these considerations, biomass is considered a transitional fuel in the transition away from fossil fuels.

Relationship to Other Measures

To maximize the percentage contribution from renewable sources of electricity, the electricity demand must first be minimized by reducing energy consumption (such as by using natural instead of mechanical ventilation or by using automatic lighting controls).

⁶⁶ Source: <https://news.energysage.com/what-are-the-most-efficient-solar-panels-on-the-market/> accessed Nov. 30, 2017

⁶⁷ <https://www.nsenerybusiness.com/features/newsmajor-pros-and-cons-of-biomass-energy-5845830/>

ENERGY EFFICIENCY MEASURES IN EDGE

Compliance Guidance

Design Stage	Post-Construction Stage
<p>At the design stage, the following must be used to demonstrate compliance:</p> <ul style="list-style-type: none"> • Briefly describe the system type • Supporting calculation showing the proposed system will deliver sufficient electricity to achieve the claimed proportion of total demand; and • Manufacturer’s data sheets for the proposed system including peak and average production wattage; and • Engineering drawings showing the system size and location, In the case of solar panels, include the orientation and angle of the panels. 	<p>At the post-construction stage, the following must be used to demonstrate compliance:</p> <ul style="list-style-type: none"> • Documents from the design stage if not already submitted. Include any updates made to the documents to clearly reflect As-Built conditions; and • Photographs of the installed system; or • Purchase receipts of the system; or • Contract with the energy management company if the system is owned by a third party. <p>Existing building projects</p> <ul style="list-style-type: none"> • If some of the documents required above are not available, other evidence of construction details, such as existing building drawings or photographs can be submitted.

ENERGY EFFICIENCY MEASURES IN EDGE

EEM34 – ADDITIONAL ENERGY SAVING MEASURES

Requirement Summary

This measure can be used to claim energy savings from strategies and technologies that are not included in the list of EDGE measures. The project must file a Special Ruling Request to get approval to claim the savings.

Intention

The intent of this measure to invite project teams to save energy using strategies and technologies beyond the measures listed in EDGE.

Approach/Methodologies

The specific approach would depend on the strategies and technologies applied. But in every case, the project team must provide the following:

1. Describe the Base Case and Improved Case scenarios with evidence
2. Provide calculations that demonstrate the expected savings
3. Present the resulting savings as a percentage of the annual energy use

Potential Technologies/Strategies and Relationship to Other Measures

These will be based on the energy saving strategy deployed.

Compliance Guidance

Design Stage	Post-Construction Stage
<p>At the design stage, the following must be used to demonstrate compliance:</p> <ul style="list-style-type: none">• Drawings showing the design intent; and• Calculations showing the percentage of energy savings compared to the EDGE baseline.	<p>At the post-construction stage, the following must be used to demonstrate compliance:</p> <ul style="list-style-type: none">• Documents from the design stage if not already submitted. Include any updates made to the documents to clearly reflect As-Built conditions; and• Photographs of the installed system; or• Purchase receipts of the system; or• Contract documents if the system is owned by a third party. <p>Existing building projects</p> <ul style="list-style-type: none">• If some of the documents required above are not available, other evidence of construction details, such as existing building drawings or photographs can be submitted.

ENERGY EFFICIENCY MEASURES IN EDGE

EEM35 – OFFSITE RENEWABLE ENERGY PROCUREMENT

Requirement Summary

The measure can be claimed if a contract has been signed for the procurement of new off-site renewable energy that is specifically allocated to the building project. Renewable energy includes any carbon-free energy that is generated without the use of fossil fuels, such as that sourced from solar, wind, tidal, or biomass resources. This measure does not impact operational CO₂ savings, but it reduces the total carbon footprint of the project. This measure can be claimed for a Zero Net Carbon⁶⁸ certification only once the project has achieved 40% or greater savings in Energy.

Intention

Investment in off-site renewable energy supports the creation of new clean energy resources on the electrical grid. This allows projects to access renewable energy even if they are in a dense urban environment and do not have sufficient open space or solar access to generate energy on site. Supporting off-site renewable energy can accelerate the reduction of greenhouse gas emissions associated with the energy sector. Additionally, by increasing renewable energy capacity on the grid, these resources may become more accessible or affordable for a greater number of electricity consumers.

Approach/Methodologies

To claim this measure, the design team must specify the quantity of off-site renewable energy that was contractually procured for the building project. If an entity associated with the project has already made general procurements of off-site renewable energy at an organization level, it must be demonstrated that a specific allocation was made for the exclusive use of the building. Off-site renewable energy procurements are typically transacted in blocks of energy units over the course of a year, such as kilowatt hours or equivalent BTU of electricity. When off-site renewable energy procurements are entered into the EDGE app, the quantity is compared to the annual electricity use to give a percentage offset.

Potential Technologies/Strategies

Off-site renewable energy may be procured from a variety of sources that are typically regionally dependent. In some countries, utility providers have established formal programs to support renewable energy development through a premium rate that is charged directly to the consumer's electricity bill, known as "green power" purchasing. Alternatively, third-party providers may have established individual projects or other community-based cooperatives to allow collective procurement of renewable energy at the local level. Where regional renewable energy resources do not exist, projects may also consider procurement of renewable energy certificates (RECs) or other transferrable credits that can be sourced from a broader range of locations. These

⁶⁸ "A Zero Net Carbon building is a highly energy efficient building that produces on-site, or procures, enough carbon-free renewable energy to meet building operations energy consumption annually." Source: Architecture 2030.

ENERGY EFFICIENCY MEASURES IN EDGE

credits essentially transfer the value of renewable energy generated from the system owner to a consumer on the open market.

Project teams should refer to their local jurisdiction or regulatory authority for a definition of acceptable forms of renewable energy. In general, the EDGE tool will not accept forms of renewable energy that involve the combustion of fossil fuels or other non-renewable carbon-based resources.

Relationship to Other Measures

Off-site renewable energy procurements may be made in combination with other measures that reduce the use of fossil fuel or carbon-based energy resources for building construction and operations. These may include energy efficiency measures that improve the passive performance of a building, such as increased insulation or higher efficiency glass; the reduction of fossil fuel energy use in active systems, such as through high efficiency equipment; or the replacement of fossil-fuel based electricity from the grid with on-site generated renewable energy. The goal of combining these energy use reduction and replacement measures would be to utilize renewable energy for all energy demands on site.

Compliance Guidance

The design team must be able to provide documentation of the origin and type of off-site renewable energy procurements, including the name of the provider. This documentation should include a copy of a signed contract or other formal agreement to confirm allocation of the of the off-site renewable energy. Note: off-site renewable energy procurements must be associated with new projects that are retired from the market after the energy is procured.

Design Stage	Post-Construction Stage
No documentation is required at the design stage.	At the post-construction stage, the following must be used to demonstrate compliance: <ul style="list-style-type: none">• Copy of contract or other formal document stating the quantity and term of renewable energy provided to the project; and• Description of the form of renewable energy that is procured and its origin or project name; and• Documentation that it meets the definition of any applicable local authority

ENERGY EFFICIENCY MEASURES IN EDGE

EEM36 – CARBON OFFSETS

Requirement Summary

The measure can be claimed if a contract has been signed for investment in a carbon offset project. Carbon offsets represent funding for third-party action to reduce or recapture carbon emissions that would otherwise be emitted to the atmosphere. This measure does not impact operational CO₂ savings, but it reduces the total carbon footprint of the project. This measure can be claimed for a Zero Net Carbon⁶⁹ certification only once the project has achieved EDGE Advanced certification (40% or greater savings in Energy).

Intention

Investing in carbon offsets reduces the net impact of building construction and operations to the atmosphere. By putting a value on carbon emissions reduction, the market is incentivized to implement additional measures to mitigate carbon emissions impact.

Approach/Methodologies

To claim this measure, the design team must specify the amount of carbon offsets that have been procured with a signed contract. Typically, each carbon offset unit represents the mitigation of one metric ton of carbon dioxide or equivalent greenhouse gas. When carbon offsets are claimed in the EDGE app, the offset value is compared to the total estimated carbon emissions of the improved case in order to calculate the total offset percentage

Potential Technologies/Strategies

Many different carbon offset products are available from providers that represent projects across a range of sectors and regions. While the most common carbon offset projects are related to funding new renewable energy installations, such as solar or wind energy, several other projects are available related to energy efficiency upgrades, methane or carbon capture and sequestration and forestry restoration. The EDGE tool does not make restrictions on the type or origin of carbon offsets, though project teams may choose to procure specific offset products based on their desired impact (e.g. support clean energy development) or a preference for locally-based projects. While the EDGE tool recognizes carbon offsets equally based on the equivalent metric tons of CO₂, the cost of individual carbon offsets may vary depending on regional availability and project type.

Relationship to Other Measures

Carbon offsets may be applied in combination with other measures that reduce the emissions associated with building construction and operations. These may include energy efficiency measures that improve the passive

⁶⁹ "A Zero Net Carbon building is a highly energy efficient building that produces on-site, or procures, enough carbon-free renewable energy to meet building operations energy consumption annually." Source: Architecture 2030.

ENERGY EFFICIENCY MEASURES IN EDGE

performance of a building, such as increased insulation or higher efficiency glass; the reduction of fossil fuel energy use in active systems, such as through high efficiency equipment; or the replacement of fossil-fuel based electricity from the grid with on-site generated or off-site procured renewable energy. Together, carbon reduction measures can be combined with carbon offsets to achieve a zero-net carbon balance for the building.

Compliance Guidance

The design team must be able to provide documentation of the origin and type of carbon offset procured, the organization issuing the offset, and evidence of third-party verification by the appropriate regulatory authority. Finally, a copy of a signed contract must be provided to confirm execution of the carbon offsets. Note: carbon offsets must be new projects that are retired after the offset is issued. Also, EDGE does not recognize carbon offsets that are based on materials combustion.

Design Stage	Post-Construction Stage
No documentation is required at the design stage.	At the post-construction stage, the following must be used to demonstrate compliance: <ul style="list-style-type: none">• Documentation of the carbon offset provider, stating formal certification or other third-party verification by an appropriate authority; and• Description of carbon offset project, including the methods by which carbon reductions are made; and• Copy of contract or other formal document stating the amount of offsets procured in equivalent metric tons of CO₂

ENERGY EFFICIENCY MEASURES IN EDGE

EEM37 – LOW IMPACT REFRIGERANTS

Requirement Summary

The measure can be claimed if a project is using refrigerants with low Global Warming Potential.

Intention

Conventional refrigerants have high Global Warming Potential (GWP), and refrigerants that end up in the atmosphere through leakage or mismanagement at the end of life have a disproportionate impact on global warming. The intent of this measure is to reduce the amount of conventional refrigerants being used in buildings. GWP is measured using a 100-year value for comparison, where the 100-year GWP of carbon dioxide (CO₂) is taken as 1. The GWP of the most common refrigerant used today, R-22, has almost 2,000 times the potency of carbon dioxide⁷⁰. So, just one pound (about half a kilogram) of R-22 is nearly as potent as a ton of carbon dioxide in its ability to cause global warming.

Approach/Methodologies

To claim this measure, the design team must describe the system sizes (kW), their refrigerant type, refrigerant charge (kg/KW), and leakage (%) in the detailed entry mode in the EDGE App.

Potential Technologies/Strategies

Solutions include:

1. The replacement of HCFCs and HFCs-based systems and materials with the ones using substances with low GWP (with 100-year GWP values below 700) for mechanical systems utilizing refrigerants, such as air-conditioning systems or cold storage in retail stores and warehouses. For example, in the refrigeration and air conditioning systems, refrigerant alternatives may include: HFOs, blended HFCs, ammonia, and CO₂ (it might be noted that changing a refrigerant may require changing the refrigeration system itself);
2. (2) not-in-kind (NIK) solutions, such as an improved system design that reduces refrigerant use, evaporative coolers (swamp coolers) that do not use refrigerants (because the water acts as a coolant); and
3. Effective maintenance procedures to minimize leakage.

The table below provides a quick reference list of low GWP and natural refrigerants that may be used for air conditioning, heating-only heat pumps, and mechanical refrigeration. For a deeper discussion of low-GWP refrigerants, see the whitepaper titled '[Refrigerant Selection to Reduce Climate Impact](#)' available on the EDGE

⁷⁰ R-22 has a 100-year GWP of 1,810. Reference: High-GWP Refrigerants by the [California Air Resources Board](#)

ENERGY EFFICIENCY MEASURES IN EDGE

website. Note that the paper was published in 2017, and newer synthetic refrigerants with low GWP may have been developed since then.

Refrigerant	Common Name	Chemical Name	GWP
R-717	Ammonia	Ammonia	0
R-718	Water		0
R-744	Carbon dioxide	CO ₂	1

Relationship to Other Measures

Carbon offsets may be applied in combination with other measures that reduce the emissions associated with building construction and operations. These may include energy efficiency measures that improve the passive performance of a building, such as increased insulation or higher efficiency glass; the reduction of fossil fuel energy use in active systems, such as through high efficiency equipment; or the replacement of fossil-fuel based electricity from the grid with on-site generated or off-site procured renewable energy. Together, carbon reduction measures can be combined with carbon offsets to achieve a zero-net carbon balance for the building.

Compliance Guidance

Design Stage	Post-Construction Stage
<p>At the design stage, the following must be used to demonstrate compliance:</p> <ul style="list-style-type: none"> • Documentation of the proposed system sizes for all equipment types in the project that use refrigerants including refrigerators, freezers, or air conditioning systems, and • The types and amounts of refrigerant charge for these systems; and • The associated global warming potential. 	<p>At the post-construction stage, the following must be used to demonstrate compliance:</p> <ul style="list-style-type: none"> • Documents from the design stage if not already submitted. Include any updates made to the design stage documents to clearly reflect as-built conditions; and • Photographs of the system and refrigerant during installation; or • Purchase receipts of the system and refrigerants. <p>Existing building projects</p> <ul style="list-style-type: none"> • If some of the documents required above are not available, other evidence, such as receipts showing the refrigerant type and charge noted during system maintenance can be submitted.

WATER EFFICIENCY MEASURES IN EDGE

WATER EFFICIENCY MEASURES

Water efficiency is one of the three main resource categories that comprise the EDGE standard. To comply for certification purposes, the design and construction team must review the requirements for selected measures as indicated and provide the information.

Required measures in EDGE do not mean that the improved case must meet or exceed the baseline case. Rather, it means that the actual performance of water fixtures is required to be entered in EDGE. If the final installed fixtures have variation in performance for any reason, a weighted average of the performance metric must be used.

Note: Flow rates used in this User Guide are global baseline assumptions and may differ from rates used in EDGE for countries in which it has been calibrated.

The following pages explain each water efficiency measure by relaying the intention, approach, assumptions and compliance guidance requirements.

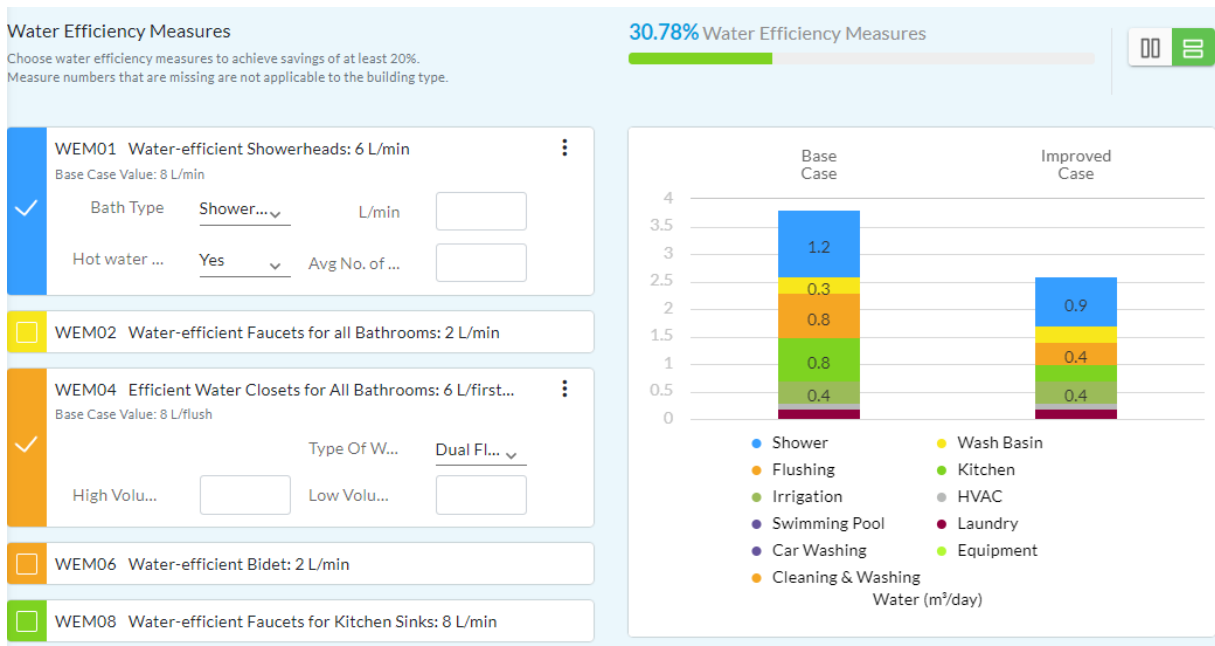

Figure 30. Screenshot of water saving measures in EDGE for Homes

WATER EFFICIENCY MEASURES IN EDGE

WEM01 – WATER-EFFICIENT SHOWERHEADS

Requirement Summary

The actual flow rate of showerheads should be entered into the software in all cases, irrespective of whether the value is low or high. Savings can be achieved if the average flow rate of the showerheads is less than the base case flow rate.

Building Type	Spaces that must have low flow showerheads
Homes	All bathrooms
Hospitality	Guest rooms
Hospitals	All bathrooms
Education	All bathrooms

Intention

By specifying low-flow showerheads, water use is reduced without adversely affecting the functionality.

Approach/Methodologies

The flow rate of a shower can be as low as 6 liters per minute or greater than 20 liters per minute. As the flow rate of a showerhead is dependent on the water pressure, manufacturers often provide a chart which plots the flow rate at different pressures. For consistency, the flow rate used for the EDGE assessment in the design/pre-construction phase must be that quoted for the operating pressure of 3 bar (43.5 psi). At the post-construction stage, actual flow rates must be used. If the pressure and flow rates of the showerheads vary across a project after construction, a weighted average at full flow must be used. Multiple measurements must be made across a variety of locations and floors to come up with a weighted average.

This measure can be claimed if the actual flow rate is entered and is lower than the Base Case. A flow rate that is lower than the default value for the design case contributes to even greater water savings.

Potential Technologies/Strategies

Many different showerheads are available that meet the flow rate required. To maintain user satisfaction at the lower flow rates, some manufacturers mix water with air to cause turbulence in the flow; this in turn gives an increased sense of pressure without increasing the flow rate.

WATER EFFICIENCY MEASURES IN EDGE

Relationship to Other Measures

Higher flow rate showers use a significant quantity of hot water. Reducing the flow rate of the shower reduces the energy required to produce hot water. Therefore, both water consumption from showers, and energy consumption due to hot water, are reduced. The energy used to pump the water is also reduced.

Compliance Guidance

Design Stage	Post-Construction Stage
<p>At the design stage, the following must be used to demonstrate compliance:</p> <ul style="list-style-type: none">• Plumbing drawings/specifications including make, model, and flow rate of the showerhead(s); and• Manufacturer’s data sheets for the specified showerhead(s) confirming the flow rate at a standard pressure of 3 bar.	<p>At the post-construction stage, the following must be used to demonstrate compliance:</p> <ul style="list-style-type: none">• Documents from the design stage if not already submitted. Include any updates made to the documents to clearly reflect As-Built conditions; and• On site test results using actual water pressure on site, which will supersede the standard design flow rate values; with average flow rate sampled from multiple locations, floors, or units, as applicable, measured at the highest flow per minute, using a timer and a measurement container; and• Date-stamped photographs of the showerhead(s) taken during or after installation showing the make and model; or• Purchase receipts for the showerheads showing the make and model. <p>Existing building projects</p> <ul style="list-style-type: none">• If some of the documents required above are not available, other evidence of construction details, such as existing building drawings or photographs can be submitted.

WATER EFFICIENCY MEASURES IN EDGE

WEM02* – WATER-EFFICIENT FAUCETS FOR PRIVATE/ALL BATHROOMS

Requirement Summary

This measure applies to “private” bathrooms, and to “all” bathrooms in buildings where the private and public bathrooms are not differentiated. Savings can be achieved if the flow rate of the faucets specified for the washbasins in the bathrooms are less than the base case in liters per minute. This low-flow rate must be obtained using aerators and auto shut off controls.

Building Type	Spaces that must have low flow faucets
Homes	All Bathrooms
Hospitality	Guest room bathrooms
Retail	Private bathrooms
Offices	Private bathrooms
Hospitals	Private bathrooms
Education	Private bathrooms

Intention

By specifying aerators and auto shut-off faucets for washbasins and sinks, water use is reduced without adversely affecting functionality.

Approach/Methodologies

As the flow rate of a faucet is dependent on the water pressure, manufacturers often provide a chart that plots the flow rate at different pressures. To improve consistency, the flow rate used for the EDGE assessment in the design/pre-construction phase must be that quoted for the operating pressure of 3 bar (43.5 psi). At the post-construction stage, actual flow rates must be used. If this flow rate is not available, physical measurements can be made on site using a bucket of a known size and a timer to record the flow rate. Multiple measurements must be made across a variety of locations and floors to come up with a weighted average.

If the measure is claimed, then the default improved case assumes aerated, auto shut-off faucets with a default flow rate of 2 liters per minute in all the washbasins included in the measure. If the flow rate is greater than 2 liters per minute but lower than the baseline in liters per minute, the measure can still be claimed if the actual flow rate is entered. The lower the flow rate the greater the water savings.

The base case assumptions vary by location. Globally, the typical baseline flow rate is 6 liters per minute for the faucets in washbasins; the base case assumes that the faucets do not have auto shut-off technology.

WATER EFFICIENCY MEASURES IN EDGE

Potential Technologies/Strategies

This measure includes two technologies fitted to the faucet – aerators and auto shut-off valves – which must be purchased as one product.

Aerators are small water-saving devices attached to the faucet that maintain user satisfaction at the lower flow rates. They mix water with air to cause turbulence in the flow; this in turn gives an increased sense of pressure without increasing the flow rate. They are also called flow regulators.

Auto shut-off faucets are activated by a push action or electronic sensors that allow the water flow to last for a programmed length of time, usually 15 seconds. After this period the faucet shuts off automatically, which is ideal for public and unsupervised washing areas.

Flow restrictors or aerators can be added on to the specified faucets to reduce the flow rate, which may be a cheaper alternative to purchasing a low-flow faucet.

Relationship to Other Measures

Reducing the flow rate of all the washbasin faucets in the building reduces the water demand and the energy required to produce hot water for the faucets. It also reduces the energy used to pump the water.

Compliance Guidance

Design Stage	Post-Construction Stage
<p>At the design stage, the following must be used to demonstrate compliance:</p> <ul style="list-style-type: none">• Plumbing drawings/specifications including make, model, and flow rate of the washbasin faucet(s); and• Manufacturer’s data sheets for the specified faucet(s)/flow aerator(s) confirming the flow rate at a standard pressure of 3 bar.	<p>At the post-construction stage, the following must be used to demonstrate compliance:</p> <ul style="list-style-type: none">• Documents from the design stage if not already submitted. Include any updates made to the documents to clearly reflect As-Built conditions; and• On site test results using actual water pressure on site, which will supersede the standard design flow rate values; with average flow rate sampled from multiple locations, floors, or units, as applicable, measured at the highest flow per minute, using a timer and a measurement container; and• Date-stamped photographs of the faucet(s) taken during or after installation showing the make and model; or• Purchase receipts for the faucet(s) showing the make and model. <p>Existing building projects</p> <ul style="list-style-type: none">• If some of the documents required above are not available, other evidence of construction details, such as existing building drawings or photographs can be submitted.

WATER EFFICIENCY MEASURES IN EDGE

WEM03* – WATER-EFFICIENT FAUCETS FOR PUBLIC BATHROOMS

Requirement Summary

The requirements for this measure are the same as for the previous measure “WEM02 - Water-Efficient Faucets for Private Bathrooms,” except that they apply to public bathrooms instead of private bathrooms. The following table lists the typical spaces to which this measure applies.

Building Type	Spaces that must have low flow faucets
Homes and Apartments	N/A
Hospitality	Public bathrooms in lobbies, gyms etc. (all except guest rooms)
Retail	Public bathrooms
Offices	Public bathrooms
Hospitals	Public bathrooms
Education	Public bathrooms

WATER EFFICIENCY MEASURES IN EDGE

WEM04* – EFFICIENT WATER CLOSETS FOR PRIVATE/ALL BATHROOMS

Requirement Summary

This measure applies to “private” bathrooms, and to “all” bathrooms in buildings where the private and public bathrooms are not differentiated. This measure can be claimed when the water closets in the bathrooms have a dual flush mechanism, or if they have an efficient single flush or flush valve. It is required that the actual flush rate of water closets be entered in EDGE in all cases, irrespective of the value.

Intention

Installing dual flush water closets helps to reduce the water used for flushing by providing a reduced flush option when a full flush is not required. Installing a more water efficient single flush water closet or flush valve similarly helps to reduce the water used to flush.

Approach/Methodologies

This measure will result in savings if the main flush is less than the base case in liters/flush and/or if the second flush is less than the base case in liters/flush. The default flush volumes for the improved case must be replaced with the actual values provided by the manufacturer.

In the case of a more efficient single flush system, select the Single flush/flush valve choice in EDGE. The actual flush value must be entered in the field for the volume of the flush. If the volumes of the flush vary across a project, a weighted average must be used. Multiple measurements must be made across a variety of locations and floors to come up with a weighted average.

Potential Technologies/Strategies

Dual-flush water closets have two flush levers where the smaller volume flush is recommended for liquid waste, and the higher volume flush for solid waste. The design team should be careful to select dual-flush water closets with clear intuitive controls, and a good flush performance rating. In some cases, dual-flush water closets can adversely increase the volume of water used if the method of use is not clear, or if they do not flush the waste adequately, requiring repeat flushes. The Environmental Protection Agency in the U.S. has a label, “WaterSense,”⁷¹ with tests for water efficiency and performance, for high-performance water closets. The EPA website is a useful reference to identify dual flush water closets which have low water use but equivalent flushing performance to water closets with higher flush volumes.

⁷¹ Water Sense, US Environmental Protection Energy. 2014. <http://www.epa.gov/WaterSense/index.html>

WATER EFFICIENCY MEASURES IN EDGE

Relationship to Other Measures

This measure is not affected by any other measure. However, this measure impacts the energy consumption of water pumps in the building as the total volume of water pumped changes (this portion of the energy consumption is included within the Energy Use category "Other").

Compliance Guidance

Design Stage	Post-Construction Stage
<p>At the design stage, the following must be used to demonstrate compliance:</p> <ul style="list-style-type: none">• Plumbing drawings/specifications including make, model and flush volumes of water closet(s); and• Manufacturer's data sheets for the specified water closet(s) with information on the flush volume of the main and reduced flushes.	<p>At the post-construction stage, the following must be used to demonstrate compliance:</p> <ul style="list-style-type: none">• Documents from the design stage if not already submitted. Include any updates made to the documents to clearly reflect As-Built conditions; and• Date-stamped photographs of the water closet(s) taken during or after installation showing the make and model; or• Purchase receipts for the water closet(s) showing the make and model. <p>Existing building projects</p> <ul style="list-style-type: none">• If some of the documents required above are not available, other evidence of construction details, such as existing building drawings or photographs can be submitted.

WATER EFFICIENCY MEASURES IN EDGE

WEM05* – EFFICIENT WATER CLOSETS FOR PUBLIC BATHROOMS

Requirement Summary

The requirements for this measure are the same as for the previous measure, WEM04 – “Efficient Water Closets for Public Bathrooms” except that they apply to the public bathrooms in a building.

WEM06 – WATER-EFFICIENT BIDET

Requirement Summary

This measure can be claimed when the bidets in all bathrooms of the building have an efficient flow rate. It is required that the actual flow rate of bidets be entered in EDGE in all cases, irrespective of whether the selected fixture is an improvement or not compared to the base case.

Intention

Installing water-efficient bidets helps to reduce water use.

Approach/Methodologies

This measure will result in savings if the flow rate is less than the base case in liters/minute. The default flow rate for the improved case must be replaced with the actual values provided by the manufacturer.

If the flow rates vary across a project, a weighted average must be used. Multiple measurements must be made across a variety of locations and floors to come up with a weighted average.

Potential Technologies/Strategies

Water-efficient bidets have a lower flow rate compared to standard. The design team should be careful to select bidets with a good performance rating. The Environmental Protection Agency in the U.S. has a label, "WaterSense,"⁷² with tests for water efficiency and performance, for high-performance water fixtures, and is a useful reference to identify water fixtures which have low water use but superior performance.

Relationship to Other Measures

This measure is not affected by any other measure. However, this measure impacts the energy consumption of water pumps in the building as the total volume of water pumped changes (this portion of the energy consumption is included within the Energy Use category "Other").

⁷² Water Sense, US Environmental Protection Agency. 2014. <http://www.epa.gov/WaterSense/index.html>

WATER EFFICIENCY MEASURES IN EDGE

Compliance Guidance

Design Stage	Post-Construction Stage
<p>At the design stage, the following must be used to demonstrate compliance:</p> <ul style="list-style-type: none"> • Plumbing drawings/specifications including make, model and flush volumes of water closet(s); and • Manufacturer’s data sheets for water closet(s) with information on the flush volume of the main and reduced flushes. 	<p>At the post-construction stage, the following must be used to demonstrate compliance:</p> <ul style="list-style-type: none"> • Documents from the design stage if not already submitted. Include any updates made to the documents to clearly reflect As-Built conditions; and • Date-stamped photographs of the water closet(s) taken during or after installation showing the make and model; or • Purchase receipts for the water closet(s) showing the make and model. <p>Existing building projects</p> <ul style="list-style-type: none"> • If some of the documents required above are not available, other evidence of construction details, such as existing building drawings or photographs can be submitted.

WEM07 – WATER-EFFICIENT URINALS

Requirement Summary

This measure can be claimed when urinals in all bathrooms of the building have a flush volume which is lower than the base case. The actual flush rate of urinals must be entered in the software in all cases, irrespective of the value.

Intention

Fitting low-flush urinals reduces the water used for flushing, ensuring efficient water use and a high level of user satisfaction with flushing performance.

Approach/Methodologies

The flush volume is measured in liters/flush. The default flush volumes for the improved case must be replaced with the actual values provided by the manufacturer. The maximum flush volume of the urinal fixture as per the manufacturer must be specified.

If the flow rates of the urinals vary across a project, a weighted average must be used. Multiple measurements must be made across a variety of locations and floors to come up with a weighted average.

There are urinals available that do not use any water, referred to as waterless urinals. For waterless urinals, a value of 0.001 Lt/flush must be entered in the field provided.

EDGE assumes on average that urinals are used two out of three instances of bathroom use in the male restrooms.

Potential Technologies/Strategies

Urinals are only provided in bathrooms for males and only accept liquid waste. Their water saving potential depends on the number of male users in the building.

Urinals that are designed to be non-adjustable above their flush volume and that are provided with drain trap functionality tend to save more water. Pressurized flushing devices and a valve provide controls and therefore water savings.

In some cases, water efficient urinals can result in an increased risk of blockages caused by the reduced volume of water. The Environmental Protection Agency in the U.S. has a label, "WaterSense," with tests for water efficiency and performance⁷³. The WaterSense label helps purchasers easily identify high-performing, water-efficient urinals, which can be found on the EPA website.

⁷³ Water Sense, US Environmental Protection Energy. 2014. <http://www.epa.gov/WaterSense/index.html> or <http://www.epa.gov/WaterSense/products/urinals.html>

WATER EFFICIENCY MEASURES IN EDGE

Type of Urinal	Description
High efficiency	Urinals that flush 2 liters or less, which are currently available from several manufacturers.
Waterless or non-water	These urinals eliminate flush valves and water use. They need special maintenance to control odors and blockages with "urine stone" deposits in the drains. This adds operation costs as well as reduced life expectancy, which should be considered.
Wall-mounted urinals with flush valves	These urinals are flushed after each use, either manually or automatically. The automatic controls can be a timer or a valve, which are useful in bathrooms of high use, such as conference areas.

Relationship to Other Measures

This measure is not affected by any other measure. However, this measure impacts building energy consumption due to a change in the energy use of water pumps as the total volume of water pumped changes (this portion of the energy consumption is included within the Energy Use category "Other").

Compliance Guidance

Design Stage	Post-Construction Stage
<p>At the design stage, the following must be used to demonstrate compliance:</p> <ul style="list-style-type: none"> Plumbing drawings/specifications including make, model and flush volume of the urinal(s); and Manufacturer's data sheets for urinal(s) with information on the flush volume. 	<p>At the post-construction stage, the following must be used to demonstrate compliance:</p> <ul style="list-style-type: none"> Documents from the design stage if not already submitted. Include any updates made to the documents to clearly reflect As-Built conditions; and Date-stamped photographs of the urinal(s) taken during or after installation showing the make and model; or Purchase receipts for the urinal(s) showing the make and model. <p>Existing building projects</p> <ul style="list-style-type: none"> If some of the documents required above are not available, other evidence of construction details, such as existing building drawings or photographs can be submitted.

WATER EFFICIENCY MEASURES IN EDGE

WEM08* – WATER-EFFICIENT FAUCETS FOR KITCHEN SINKS

Requirement Summary

The actual flow rate of kitchen sink faucets must be entered in the software in all cases, irrespective of the value. Savings can be achieved if the flow rate of the faucets specified for the kitchen sinks is less than the base case specified in liters per minute.

In some cases, these savings are not applicable. For instance, in a building without a kitchen, there will be no kitchen water faucets and therefore no savings from this measure.

Intention

By specifying low-flow faucets for kitchen sinks, water use is reduced without adversely affecting the functionality. Hot water use is also reduced, reducing energy consumption for heating the water.

Approach/Methodologies

As the flow rate of a faucet is dependent on the water pressure, manufacturers often provide a chart that plots the flow rate at different pressures. To improve consistency, the flow rate used for the EDGE assessment must be that quoted for the operating pressure of 3 bar (43.5 psi). If this flow rate is not available, physical measurements can be made on site using a bucket of a known size and a timer to record the flow rate. If the flow rates of the faucets vary across a project, a weighted average must be used. Multiple measurements must be made across a variety of locations and floors to come up with a weighted average.

If the measure is claimed, the assumed improved flow rate defaults to 4 liters per minute. If the actual flow rate is lower than the base case in liters per minute, the measure can be claimed by specifying the actual flow rate. A lower flow rate contributes to greater water savings.

Potential Technologies/Strategies

Many different faucets are available that meet the flow rate required. To maintain user satisfaction at the lower flow rates, some manufacturers mix water with air to cause turbulence in the flow; this in turn gives an increased sense of pressure without increasing the flow rate.

Flow restrictors or aerators can be added on to the specified faucets to reduce the flow rate, which may be a cheaper alternative to purchasing a low-flow faucet.

Relationship to Other Measures

Higher flow rate kitchen faucets use a significant quantity of hot water. Reducing the flow rate of the kitchen faucets reduces the energy required to produce hot water.

WATER EFFICIENCY MEASURES IN EDGE

Compliance Guidance

Design Stage	Post-Construction Stage
<p>At the design stage, the following must be used to demonstrate compliance:</p> <ul style="list-style-type: none"> • Plumbing drawings/specifications including make, model and flow rate of kitchen faucet(s) or flow restrictor(s); and • Manufacturer’s data sheets for faucet(s)/flow restrictor(s) confirming the flow rate at 3 bar. 	<p>At the post-construction stage, the following must be used to demonstrate compliance:</p> <ul style="list-style-type: none"> • Documents from the design stage if not already submitted. Include any updates made to the documents to clearly reflect As-Built conditions; and • On site test results by the auditor of the flow rate at the highest flow per minute, using a timer and a measurement container; and • Date-stamped photographs of the faucet(s) or flow restrictor(s) taken during or after installation showing the make and model; or • Purchase receipts for the faucet(s) or flow restrictor(s) showing the make and model. <p>Existing building projects</p> <ul style="list-style-type: none"> • If some of the documents required above are not available, other evidence of construction details, such as existing building drawings or photographs can be submitted.

WATER EFFICIENCY MEASURES IN EDGE

WEM09 – WATER-EFFICIENT DISHWASHERS

Requirement Summary

This measure can be claimed if all the dishwashers installed in the building are water efficient (low consumption). This can be demonstrated when the purchased dishwasher(s) use less water than the base case. The base case dishwasher uses 5 liters per rack.

Intention

Minimize the water consumed by the dishwashers installed in the building.

Approach/Methodologies

The dishwasher consumption can be as low as 4 liters per load or greater than 21 liters per load. In a load two racks can be filled up. EDGE measures the water consumption per rack, which is calculated with the maximum total water consumption in liters divided by the number of racks in the dishwasher. The maximum total water consumption is taken from the manufactures datasheet on the cycle of the dishwasher that uses the most water. This measure can be claimed if the dishwasher uses 2 liters per rack or less.

Potential Technologies/Strategies

Dish washers overview	Key features for Efficiency
About 60% of the energy used by a dishwasher goes towards water heating; therefore, models that use less water also use less energy.	An efficient dishwasher should: <ul style="list-style-type: none">• Be the right size for the building• Have several wash cycles• Enable pre-rinse to be skipped• Have soil sensors, which test how dirty dishes are and adjust the cycle to reduce water and energy use• Have more efficient jets, which use less energy to spray detergent and water• Have 'no-heat' drying feature, which circulates room air through the dishwasher by fans, rather than using electric heating• Have improved water filtration

In terms of dishwashers, the way that occupant use them also influence the water performance. It is important to provide users with guidelines outlining the benefits of these appliances, and the best way to achieve maximum efficiency.

Relationship to Other Measures

Water reduction in the 'Kitchen' section of the water chart is expected by water efficient dishwashers. Moreover, it shows reductions in energy due to equipment and pumps which is part of 'Others.'

WATER EFFICIENCY MEASURES IN EDGE

Compliance Guidance

Design Stage	Post-Construction Stage
<p>At the design stage, the one of the following must be used to demonstrate compliance:</p> <ul style="list-style-type: none"> • Summary of the dishwasher(s) to be installed in the building, including quantity and proof of maximum water use; and • Specifications from manufacturer detailing water use. 	<p>At the post-construction stage, one of the following must be used to demonstrate compliance:</p> <ul style="list-style-type: none"> • Documents from the design stage if not already submitted. Include any updates made to the documents to clearly reflect As-Built conditions; and • Updated summary of dishwasher(s) installed in the building including quantity, manufacturer, and model; or • Proof of maximum water consumption from manufacturer; and • Date-stamped photographs of the dishwasher(s) taken during or after installation showing the make and model; or • Purchase receipts for the dishwashers showing the make and model. <p>Existing building projects</p> <ul style="list-style-type: none"> • If some of the documents required above are not available, other evidence of construction details, such as existing building drawings or photographs can be submitted.

WATER EFFICIENCY MEASURES IN EDGE

WEM10 – WATER-EFFICIENT PRE-RINSE SPRAY VALVES FOR KITCHEN

Requirement Summary

This measure can be claimed if the kitchens are fitted with low flow pre-rinse spray valves for rinsing the dishes prior to be placed in the washing machine. The pre-rinse valve specified should be 6 liters per minute or less.

Intention

By specifying low-flow pre-rinse valve, water use is reduced compared to a manual rinse of the dishes.

Approach/Methodologies

As the flow rate of the pre-rinse valve is dependent on the water pressure, manufacturers often provide a chart that plots the flow rate at different pressures. To improve consistency, the flow rate used for the EDGE assessment in the design/pre-construction phase must be that quoted for the operating pressure of 3 bar (43.5 psi). At the post-construction stage, actual flow rates on site must be used for the EDGE inputs. If the flow rates of the spray valves vary across a project, a weighted average must be used.

Some of the benefits of having an efficient pre-rinse valve in the kitchen of the hospital include having an efficient cleaning but using less water and energy, which then reduce the operational costs.

Potential Technologies/Strategies

Many different pre-rinse valves are available in the market; however as the flow rate required is low, efficient spray valves need to meet 6 liters per minute flow rate. To maintain user satisfaction at the lower flow rates, manufacturers mix water with air to cause turbulence in the flow; this in turn gives an increased sense of pressure without increasing the flow rate. Pre-rinse spray valves require a lot of pressure, which is given by the air within the valve, to remove the food waste prior to dishwashing. The savings are even more noticeable because pre-rinse valves use hot water, so when water is reduced the use of energy is also dropped.

Relationship to Other Measures

Water reduction in the 'Kitchen' section of the water chart is expected by low flow pre-rinse valves. Moreover, it shows reductions in energy due to 'water heating' and water pumps which is part of 'Others'.

WATER EFFICIENCY MEASURES IN EDGE

Compliance Guidance

Design Stage	Post-Construction Stage
<p>At the design stage, the following must be used to demonstrate compliance:</p> <ul style="list-style-type: none">• Plumbing drawings/specifications including make, model, and flow rate of the pre-rinse valve(s); and• Manufacturer’s data sheets for pre-rinse valve(s) confirming the flow rate at a standard pressure of 3 bar.	<p>At the post-construction stage, the following must be used to demonstrate compliance:</p> <ul style="list-style-type: none">• Documents from the design stage if not already submitted. Include any updates made to the documents to clearly reflect As-Built conditions; and• On site test results by the auditor of the flow rate at the highest flow per minute, using a timer and a measurement container; and• Date-stamped photographs of the pre-rinse valve(s) taken during or after installation showing the make and model; or• Purchase receipts for the pre-rinse valve(s) showing the make and model. <p>Existing building projects</p> <ul style="list-style-type: none">• If some of the documents required above are not available, other evidence of construction details, such as existing building drawings or photographs can be submitted.

WATER EFFICIENCY MEASURES IN EDGE

WEM11 – WATER-EFFICIENT WASHING MACHINES

Requirement Summary

This measure can be claimed when all the washing machines used in the laundry of a hotel or serviced apartment are front loading washing machines with high water efficiency.

Intention

Using high efficient front-loading washing machines reduces the water used for laundry. Other benefits, of high efficient washing machines, include energy saving due to the reduction of hot water use, better performance in cleaning the clothes, reduce fabric wear, and usually less detergent use.

Approach/Methodologies

The measure can be claimed if all the washing machines in the laundry use 6 liters of water per kilogram of clothes washed or less.

Potential Technologies/Strategies

There are two types of washing machines available in the market, top loading and front loading. While top loading need more water in order to cover the clothes inside, the front loading require about a third. The high efficiency washers are high-tech machines that use less water (both hot and cold water) and energy, while are more effective in cleaning the clothes compared to the standard ones. This is because in the front loading the washer moves the clothes through the water using gravity to create more agitation.

Relationship to Other Measures

Using a water-efficient washing machine not only reduces cold water demand but also hot water demand. Therefore, when this measure is selected the energy consumption is decreased due to water heating, as well as miscellaneous equipment, which is included within "Others".

WATER EFFICIENCY MEASURES IN EDGE

Compliance Guidance

Design Stage	Post-Construction Stage
<p>At the design stage, the following must be used to demonstrate compliance:</p> <ul style="list-style-type: none">• Plumbing drawings/specifications including make, model, and flow rate of the washing machines; and• Manufacturer’s data sheets for washing machines confirming the water use per cycle.	<p>At the post-construction stage, the following must be used to demonstrate compliance:</p> <ul style="list-style-type: none">• Documents from the design stage if not already submitted. Include any updates made to the documents to clearly reflect As-Built conditions; and• On site verification of the model by the auditor; and• Date-stamped photographs of the washing machines taken during or after installation showing the make and model; or• Purchase receipts for the washing machines showing the make and model. <p>Existing building projects</p> <ul style="list-style-type: none">• If some of the documents required above are not available, other evidence of construction details, such as existing building drawings or photographs can be submitted.

WEM12 – SWIMMING POOL COVERS

Requirement Summary

This measure can be claimed if the building has pool(s) and these are fitted with a cover to prevent water and heat losses through evaporation.

Intention

Water and heat are lost through evaporation from the surface of the pool. The use of a cover for the entire pool(s) can reduce the use of fresh water from the municipal supply as well as energy for heating the pool.

A pool cover can also protect the pool from debris contamination, which reduces the use of chemicals and maintenance. A pool cover can provide shade in hot climates. For a heated pool in cold climates, a pool cover prevents heat loss during the night or when the pool is not in use; a transparent cover outdoors can also provide heat gain while reducing heat loss.

Approach/Methodologies

This measure can only be claimed if all the pools including outdoor and indoor pools have a suitable cover fitted to the entire pool surface. A suitable cover will include the following characteristics:

- Resistance to pool treatment chemicals and UV light;
- Thick and durable material;
- Insulation properties;
- Fully fitted to the pool;
- Easy to store and utilize; and
- Safe for both pool users and staff.

The base case assumption is that the pool does not have a fitted cover. The improved case assumes that a pool cover is adequately fitted and that the cover reduces the evaporation rate, therefore 30% of water is saved each time that the pool is refilled.

Potential Technologies/Strategies

Most pools lose water due to evaporation from the surface. Heat loss from pools occurs at the surface mostly due to evaporation, but also from radiation to the sky. These issues can easily be addressed with an affordable solution such as a pool cover.

WATER EFFICIENCY MEASURES IN EDGE

Pool covers have the following benefits:

Benefits	Description
Reduced water consumption	Surface water from a pool evaporates to the atmosphere. A pool cover for times when the pool is not in use can reduce the evaporation rate up to 98%, thus reducing the use of water to re-fill the pool.
Reduced energy consumption	In heated pools, a pool cover can be used both at daytime and nighttime to save energy, as it can gain heat as well as prevent heat losses. Standard pool temperature can rise by up to 4°C (especially in dry and cold environments), if short-wave radiation from the sun passes through a transparent cover and heats the surface of the pool. Then at night, when there is no heat gain, the cover retains the heat by reducing long-wave radiant heat losses and the evaporation rate.
Reduced chemicals consumption	When the pool is covered, it is protected from debris (leaves, twigs and litter) contamination and therefore requires less chemical (chlorine) to clean up the pool. In addition, chemicals are not dispersed to the atmosphere due to the reduction of the evaporation rate.
Reduced need of mechanical ventilation (halls)	If evaporation is prevented when the pool cover is in place, then less mechanical ventilation is required in enclosed pool halls. In addition, dehumidifiers can be shut-off during off hours. These two factors reduce the energy consumption from the mechanical ventilation system.
Reduced maintenance	Both building and pool maintenance are reduced. This is because the reduction of humidity and condensation when the pool cover is in place lessens the maintenance to prevent mold on the building structure (especially in pool halls). In addition, pool maintenance is also lessened as chemicals are saved and debris contamination is avoided.

Relationship to Other Measures

This measure does not impact other measures.

Compliance Guidance

Design Stage	Post-Construction Stage
<p>At the design stage, the following must be used to demonstrate compliance:</p> <ul style="list-style-type: none"> Sizing calculations and manufacturer's data sheets for pool cover(s) to fit the entire pool(s). 	<p>At the post-construction stage, the following must be used to demonstrate compliance:</p> <ul style="list-style-type: none"> Documents from the design stage if not already submitted. Include any updates made to the documents to clearly reflect As-Built conditions; and Date-stamped photographs of the installed pool cover(s); or Purchase receipts for the pool cover(s). <p>Existing building projects</p> <ul style="list-style-type: none"> If some of the documents required above are not available, other evidence of construction details, such as existing building drawings or photographs can be submitted.

WATER EFFICIENCY MEASURES IN EDGE

WEM13 – WATER-EFFICIENT LANDSCAPE IRRIGATION SYSTEM

Requirement Summary

This measure can be claimed if water-efficient landscaping is incorporated within the building. The water-efficient landscaping measure can be claimed if less than 4 liters of water (excluding rainwater) will be used on average per square meter of landscaping per day.

Intention

Water-efficient outdoor landscaped areas can reduce the use of fresh water from the municipal supply, as well as fertilizers and maintenance cost, while preserving the habitat of plants and wildlife.

Approach/Methodologies

This measure can only be claimed if the outdoor landscaping areas, including lawns, gardens and ponds, will use less than 4 liters of water (excluding rainwater) per square meter a day throughout the year. This can be achieved by replacing the areas planted with water-intensive plants with native and adaptive plants. Detailed guidance for selecting water-efficient plants according to the local climate would normally be carried out by the landscape designer or the supplier of the plants. However, the following can be used as a rough guide:

Outdoor landscaping water consumption, including for lawns, gardens and ponds, is calculated as:

$$\text{Landscape Water consumption} = \frac{\text{Landscape Water Requirements} - \text{Rainfall Volume}}{\text{Total Outdoor Landscaping Area}}$$

Where: *Landscape Water Requirements* = Average amount of water needed per day for all the plants within the outdoor landscaping area (in liters)

Rainfall Volume = Daily average annual rainfall (in liters)

Total Outdoor Landscaping Area = Area of outdoor lawns, gardens and ponds (m²)

WATER EFFICIENCY MEASURES IN EDGE

Potential Technologies/Strategies

According to studies, “up to 50 percent of the water applied to lawns and gardens is not absorbed by the plants. It is lost through evaporation, runoff or being pushed beyond the root zone because it is applied too quickly or more than the plants’ needs.”⁷⁴ To offset this, following are the main considerations when designing a water-efficient landscaping area:

- Use native and low water-using plants, as they require very little water beyond the local rainfall.
- Create zones of vegetation according to their water requirements. In this way, less water is wasted in irrigation as each zone is watered differently.
- Use an appropriate irrigation system. For example, a drip irrigation or under surface system can help reduce the water consumption compared to a sprinkler system.

Relationship to Other Measures

Claiming this measure reduces the water demand use for landscaping only.

Compliance Guidance

Design Stage	Post-Construction Stage
<p>At the design stage, the following must be used to demonstrate compliance:</p> <ul style="list-style-type: none">• A landscape plan showing the zoning for plants and the type of plants used, highlighting native species and the irrigation system selected; and• Description of the water requirements use in landscaped areas; or• Calculation of the landscape water consumption in liters/m²/day.• Note that protected green areas cannot be counted towards landscaped area.• Intentionally planted xeriscapes can claim zero water use.	<p>At the post-construction stage, the following must be used to demonstrate compliance:</p> <ul style="list-style-type: none">• Documents from the design stage if not already submitted. Include any updates made to the documents to clearly reflect As-Built conditions; and• Date-stamped photographs of the planted species, landscaping area and irrigation system if applicable; or• Purchase receipts for the vegetation and irrigation system if applicable. <p>Existing building projects</p> <ul style="list-style-type: none">• If some of the documents required above are not available, other evidence of construction details, such as existing building drawings or photographs can be submitted.

⁷⁴ US Environmental Protection Agency. http://www.epa.gov/WaterSense/docs/water-efficient_landscaping_508.pdf

WEM14 – RAINWATER HARVESTING SYSTEM

Requirement Summary

This measure can be claimed if a rainwater collection system is installed to supply water for use within the project. This water must be re-used on the project site to replace water consumption from the municipal water supply. End uses may include flushing toilets, the HVAC system, cleaning the building, or irrigation of landscaping.

Intention

A rainwater harvesting system can reduce the use of fresh water from the municipal supply.

Approach/Methodologies

To qualify, the collected rainwater must be re-used on the project site, and demonstrate that it replaces municipal water supply. The project team must document both the need for municipal water supply for the end-use being served, and the fact that the collected rainwater is being directed to replace it. For example, the team could submit pictures that show the planned piping system connected to an irrigation system. This would ensure that the system is reducing municipal water use.

EDGE automatically calculates the approximate maximum quantity of water that can be collected by a rainwater harvesting system using rainfall data from the project location and the size of the roof area. Although the default assumption is that the roof will serve as the rainwater collection system, a rainwater collection system located on the grounds of the project is just as acceptable provided it is properly sized. The improved case assumes that the rainwater harvesting system is adequately sized and that the rainwater collected is used internally for such purposes as flushing toilets and showers.

Detailed guidance for sizing a rainwater collection system is available on the worldwide web and would normally be carried out by the supplier of the system. However, the following can be used as a rough guide:

$$\text{Rainwater Harvesting (m}^3\text{)} = (\text{Catchment Area} * \text{Rainfall Volume} * \text{Run off Coefficient}/1000)$$

Where: *Catchment Area* = area of rooftop or hardscape (m²).

Rainfall volume = average annual rainfall (mm), also called “amount potential”

Run-off coefficient = varies depending on the surface type. some examples are as follows:

Metal roof - 0.95, Concrete/asphalt roof - 0.90, Gravel roof - 0.80

If hardscape is included, it can also be expressed as a percentage of the roof area. For example, if a building has a 1000 m² roof and another 500 m² serving as rainwater catchment area, the EDGE input for % of Roof Area used can be 150%.

When this measure is claimed, dual piping is required to avoid cross-contamination of water.

The base case assumption is that no rainwater is harvested.

WATER EFFICIENCY MEASURES IN EDGE

Potential Technologies/Strategies

The main consideration when designing a rainwater harvesting system is adequate sizing of the storage tank. The supplier/designer of the system must be able to advise on appropriate sizing, but the two key factors to consider when sizing the tank are the rate of supply (local rainfall data and collection area) and the demand (water use per day).

When harvesting the rain water, a dual piping system must be used to separate the rain water from the mains and to distribute the collected water for use at the project site (such as flushing toilets, the washing machine or showers).

Collected water must be in accordance with local or international health and sanitary code requirements (whichever are more stringent).

Relationship to Other Measures

Claiming this measure reduces the water demand for all uses considered by EDGE.

Compliance Guidance

EDGE assumes that the rainwater is being used within the building. If the rainwater is being used only to irrigate the landscape, the project team must demonstrate that (1) there is need for irrigation with municipal water (in addition to just natural rainwater) and (2) that the recycled water will be directed to this use. This can be done with drawings of the plumbing layout at the design stage, and with pictures that show the planned piping system connected to the irrigation system at the post-construction stage.

Design Stage	Post-Construction Stage
<p>At the design stage, the following must be used to demonstrate compliance:</p> <ul style="list-style-type: none">• A system schematic showing the collection area, feed pipes and storage tank; and• Sizing calculations for the rainwater harvesting system.• EDGE assumes that the rainwater is being used within the building to replace potable water use. If the harvested rainwater is being used only to irrigate the landscape, the project team must demonstrate that (1) there is need for irrigation with municipal water (in addition to just natural rainwater) and (2) that the plumbing layout shows that the recycled water will be directed to this use.	<p>At the post-construction stage, the following must be used to demonstrate compliance:</p> <ul style="list-style-type: none">• Documents from the design stage if not already submitted. Include any updates made to the documents to clearly reflect As-Built conditions; and• Date-stamped photographs of the installed rainwater harvesting system and dual piping; or• Purchase receipts for the rainwater harvesting/storage system.• If the harvested rainwater is being used for landscape, provide date-stamped photographs that show the piping system connected to the irrigation system. <p>Existing building projects</p> <ul style="list-style-type: none">• If some of the documents required above are not available, other evidence of construction details, such as existing building drawings or photographs can be submitted.

WEM15 – WASTE WATER TREATMENT AND RECYCLING SYSTEM

Requirement Summary

This measure can be claimed if there is a black water or gray water recycling system that treats the wastewater from the building. This recycled water must be re-used on the project site to replace water consumption from the municipal water supply. End uses may include flushing toilets, supplying the HVAC system, cleaning the building, or irrigation of landscaping.

Intention

By recycling the black or gray water, the use of fresh water from the municipal supply can be reduced. The load on the local water and sewage infrastructure is also reduced.

Approach/Methodologies

Gray water is defined as wastewater from potable water fixtures such as faucets and showers. Blackwater includes gray water, and in addition, it includes solid waste from toilets and kitchens that requires more intensive treatment.

When this measure is claimed, EDGE automatically calculates the potential supply of recycled water and reduces the municipal water demand by that amount across the end uses that can benefit from it. These include flushing toilets, cleaning of the building, the HVAC system, and irrigation of landscaping. The EDGE software assumes that most of the wastewater from the building is collected, treated and stored properly to meet ongoing demand. If the quantity of treated wastewater is insufficient to meet the building demand, then only a portion of the demand is shown to be met by the treated water.

- A water balance model must be produced by the design team to demonstrate the potential for water recycling.
- The recycled water must be reused for flushing toilets, with the remainder directed towards other uses. Where this water is not used for toilet flushing, the project must provide additional documentation that the system is indeed replacing municipal water supply. For example, if the recycled water is being used for irrigation only, then the project must demonstrate that (a) the landscaped area requires municipal water (in addition to just natural rainwater), and (b) the system is designed to serve the landscape, thus replacing water from the municipal supply. This can be done with drawings of the plumbing layout at the design stage, and with pictures that show the planned piping system connected to the irrigation system at the post-construction stage.

Note that gray water is included in black water, so there are no additional savings from a gray water system when a black water system is selected.

Potential Technologies/Strategies

When recycling the water, a dual piping system must be used to separate the recycled water from the main supply line.

WATER EFFICIENCY MEASURES IN EDGE

Treated water must be in accordance with local or international health and sanitary code requirements (whichever is more stringent).

In some cases, the water treatment plant can be centralized for a combination of buildings within the development. In these cases, the central plant must fall within the site boundary of the project, or managed by a company within the control of the site owner. This is to ensure continuity of sustainable management and future access to the system for maintenance. However, when the water treatment plant is located off-site, then a contract with the management company in charge of water treatment must be provided as part of the documentation at the post-construction stage.

Some jurisdictions may not permit the use of gray or black water in buildings for flushing; in such cases this measure cannot be claimed.

Relationship to Other Measures

The quantity of wastewater available depends on the efficiency of water fittings; more water-efficient buildings may have insufficient water available to completely offset the demand for flushing. This measure has an impact on "Other" Energy uses in the energy chart as water pumps required for operation of the system are included in that category.

Compliance Guidance

Design Stage	Post-Construction Stage
<p>At the design stage, the following must be used to demonstrate compliance:</p> <ul style="list-style-type: none"> • A schematic layout of the system showing the plumbing including the dual plumbing lines; and • Manufacturer's data sheets of the specified gray water treatment plant; and • Calculations including the following: <ul style="list-style-type: none"> ○ Designed capacity of the gray water treatment system in m³/day. ○ Quantity of gray water available daily to recycle in liters/day. ○ Efficiency of the gray water system to produce treated water in liters/day. ○ Water balance chart. 	<p>At the post-construction stage, the following must be used to demonstrate compliance:</p> <ul style="list-style-type: none"> • Documents from the design stage if not already submitted. Include any updates made to the documents to clearly reflect As-Built conditions; and • Date-stamped photographs of the installed system; or • Purchase receipts for the water treatment and storage system; or • Contract documents with the management company if the system is centralized or off-site. <p>Existing building projects</p> <ul style="list-style-type: none"> • If some of the documents required above are not available, other evidence of construction details, such as existing building drawings or photographs can be submitted.

WATER EFFICIENCY MEASURES IN EDGE

WEM16 – CONDENSATE WATER RECOVERY

Requirement Summary

This measure can be claimed if a condensate water recovery device with the capacity to collect all condensate water from the cooling system is installed and the condensate water is used in landscaping, toilet flushing or for outdoor uses.

Intention

By recovering the condensate water from HVAC equipment, the use of fresh water from the municipal supply can be reduced.

Approach/Methodologies

Buildings benefit from condensate water recovery, which does not require much treatment and saves water for other purposes within the building and landscaping.

To qualify, the design team must demonstrate that the HVAC system has a collection device for the condensate water recovered. The collected condensate must have a piping system and collection tank or can be directed to the rainwater collection tank if present. The collected water must be used in the building, such as for toilet flushing or on-site irrigation.

The base case assumes there is no condensate water recovery from HVAC, while the improved case assumes that all condensate water generated from the HVAC system is recovered.

Potential Technologies/Strategies

In the context of buildings, condensate water recovery aims to re-use the water arising from the dehumidification of the air in HVAC or refrigeration systems. When the air passes through the cold coil of the system, the temperature of the air is decreased and the vapor (humidity) changes from gas to liquid, which can then be removed as condensate. It is essentially distilled water with low mineral content, but it can potentially contain harmful bacteria such as *Legionella*⁷⁵. This water can potentially be used anywhere in the building except for drinking, if proper treatment to address biological contaminants is considered. Potential use of condensate water includes:

- Irrigation: generally safe to use without treatment, if used as surface irrigation;
- Cooling towers: treatment is needed;
- Water for decorative ponds or fountains: treatment is needed;
- Toilet and urinal flushing: treatment is needed;
- Rainwater recycle system: condensate can be a source to feed the system; and
- Laundry and washing: biocide treatment required.

⁷⁵ Boulware, B. Environmental leader magazine. *Air Conditioning Condensate Recovery*, January 15, 2013.

WATER EFFICIENCY MEASURES IN EDGE

Condensate can be a constant source of water if the HVAC system is in use. It can generate between 11 to 40 liters/day per 100m² of conditioned space⁷⁶, depending on the HVAC system type and operation.

Collected water must be in accordance with local or international health and sanitary code requirements (whichever are more stringent).

Relationship to Other Measures

Claiming this measure reduces the water demand for the kitchen (dishwasher, rinse valve and faucets), bathroom faucets, the HVAC system and "Other" Water use, which is mainly cleaning.

Compliance Guidance

Design Stage	Post-Construction Stage
<p>At the design stage, the following must be used to demonstrate compliance:</p> <ul style="list-style-type: none">• Calculations for condensate water recovery specifying cooling load and water collected in liters per day; and• Hydraulic layout showing the location and technology of the recovery, collection, and reuse components.	<p>At the post-construction stage, the following must be used to demonstrate compliance:</p> <ul style="list-style-type: none">• Documents from the design stage if not already submitted. Include any updates made to the documents to clearly reflect As-Built conditions; and• Date-stamped photographs of installed system; or• Purchase receipts for the condensate recovery system. <p>Existing building projects</p> <ul style="list-style-type: none">• If some of the documents required above are not available, other evidence of construction details, such as existing building drawings or photographs can be submitted.

⁷⁶ Alliance for Water Efficiency website. http://www.allianceforwaterefficiency.org/condensate_water_introduction.aspx

WATER EFFICIENCY MEASURES IN EDGE

WEM17 – SMART METERS FOR WATER

Requirement Summary

This measure can be claimed when smart metering is provided for each owner or tenant of the building. The owners may subscribe to an online monitoring system. Note that this measure cannot be claimed when 'prepaid meters' are installed as they are not considered smart meters under EDGE.

The smart meter must be able to show readings of the last hour, last day, last 7 days and last 12 months of usage data, and the devices should be accessible within the home. Other objectives of the smart meters are:

- Measure water use;
- Analyze measurements;
- Relatively low price;
- The smart meters solution must be workable in offline households with no web dependency.

Intention

The intent is to reduce demand through increased awareness of consumption. With smart meters, end-users can appreciate, understand, and contribute to responsible use of water in the building. Smart meters can display measurements and recommendations.

Approach/Methodologies

When smart meters are installed, end-users receive immediate feedback that can result in 10 to 20% water savings, as they are able to identify consumption in more detail than with conventional meters.

The base case assumes conventional meters, while the improved case assumes smart meters to be installed for each tenant or household.

Potential Technologies/Strategies

Smart metering is designed to provide occupants with information on a real-time basis about their water consumption. This may include data on how much water they are consuming, and the costs.

A detection unit (the transmitter) is affixed to an existing utility meter and tracks water use. The display unit receives a wireless signal from the transmitter and displays the consumption information in real time and cost

WATER EFFICIENCY MEASURES IN EDGE

for the end user. Many companies also offer online monitoring systems⁷⁷ which require little to no additional equipment installation.

The benefits of smart metering include controlling demand; signaling the need for preventive maintenance or repairs; optimizing operational efficiency with controlled costs; and maximizing property values.

For best results it is recommended that separate smart meters be used for different uses. This will offer better visibility of usage and therefore better management.

Relationship to Other Measures

The contribution made by the measure is reflected in the common amenities portion of the water chart. Although EDGE does not show savings in other areas of water consumption, this measure increases end user awareness, which in the long term can help to significantly reduce water consumption and potentially, the energy required to heat water.

Compliance Guidance

Design Stage	Post-Construction Stage
<p>At the design stage, the following must be used to demonstrate compliance:</p> <ul style="list-style-type: none">• Plumbing drawings/specifications including the make and model of smart meters and the connection with the water supply system, or an equivalent system online; and• Manufacturer's specifications of the smart meters.	<p>At the post-construction stage, the following must be used to demonstrate compliance:</p> <ul style="list-style-type: none">• Documents from the design stage if not already submitted. Include any updates made to the documents to clearly reflect As-Built conditions; and• Date-stamped photographs of the installed smart water meters showing the make and model; or• Purchase receipts for the smart water meters showing the make and model; or• Purchase receipts of subscription(s) to the equivalent online system. <p>Existing building projects</p> <ul style="list-style-type: none">• If some of the documents required above are not available, other evidence of construction details, such as existing building drawings or photographs can be submitted.

⁷⁷ For example, <http://www.theenergydetective.com/> or http://efergy.com/media/download/datasheets/ecotouch_uk_datasheet_web2011.pdf

WATER EFFICIENCY MEASURES IN EDGE

WEM18 – ADDITIONAL WATER SAVING MEASURE

Requirement Summary

This measure can be used to claim water savings from strategies and technologies that are not included in the list of EDGE measures. The project must file a Special Ruling Request to get approval to claim the savings.

Intention

The intent of this measure to invite project teams to save water using strategies and technologies beyond the measures listed in EDGE.

Approach/Methodologies

The specific approach would depend on the strategies and technologies applied. But in every case, the project team must provide the following:

4. Describe the Base Case and Improved Case scenarios with evidence
5. Provide calculations that demonstrate the expected savings
6. Present the resulting savings as a percentage of the annual water use

Potential Technologies/Strategies and Relationship to Other Measures

These will be based on the water saving strategy deployed.

Compliance Guidance

Design Stage	Post-Construction Stage
<p>At the design stage, the following must be used to demonstrate compliance:</p> <ul style="list-style-type: none">• Drawings showing the design intent; and• Calculations showing the percentage of water savings compared to the EDGE baseline.	<p>At the post-construction stage, the following must be used to demonstrate compliance:</p> <ul style="list-style-type: none">• Documents from the design stage if not already submitted. Include any updates made to the documents to clearly reflect As-Built conditions; and• Photographs of the installed system; or• Purchase receipts of the system; or• Contract documents if the system is owned by a third party. <p>Existing building projects</p> <ul style="list-style-type: none">• If some of the documents required above are not available, other evidence of construction details, such as existing building drawings or photographs can be submitted.

MATERIALS EFFICIENCY MEASURES

Materials efficiency is one of the three main resource categories that comprise the EDGE standard. To comply for certification purposes, the design and construction team must review the requirements for selected measures as indicated and provide the information.

The following pages explain each materials efficiency measure by relaying the intention, approach, assumptions and compliance guidance requirements. For a more detailed view of the embodied energy and images for the material options included in the Potential Technologies, see the companion reference guide called the EDGE Materials Reference Guide.

The Materials section includes Efficiency Measures for the following building elements: floor slabs, roof construction, external walls, internal walls, flooring, window frames, roof insulation and wall insulation. Structural elements are not included within this section because the structure should be designed as per safety and other engineering considerations and will not be altered. Structural engineers might consider lower embodied energy structures; however, EDGE excludes the structure from all embodied energy calculations. The main reason is to avoid any potential impact on the integrity of structural design considerations.

In addition to the selection of materials, the thickness can be specified for some elements in this section. However, changing these thickness values does not influence the building size or internal floor areas. For example, if the floor slab thickness is changed from 200mm to 500mm, the default volume and height of the room will be maintained in the calculations for other aspects, such as energy.

All materials measures marked with an asterisk (*) on the measure name such as HMM01* must be specified as per actual building conditions. For building elements where more than one material may be selected, a second predominant material that covers more than 25% of the area can optionally be indicated and marked with its percentage (%) area in the total project. Any additional materials beyond the first two must be represented by one of the two selected materials that is nearest to it in embodied energy. For projects being modeled with multiple EDGE models, the preferred method is to calculate the average distribution of materials over the entire project and use the same selections and percentage (%) figures across all models.

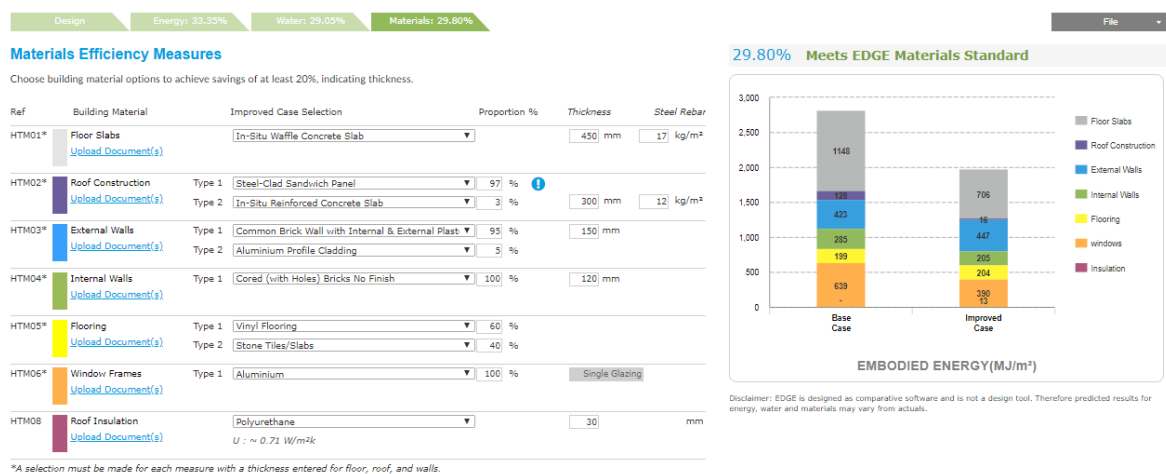

Figure 31. Screenshot of Materials saving measures in EDGE for Hospitality

MATERIALS EFFICIENCY MEASURES IN EDGE

EDGE provides default embodied energy values for the materials based on the EDGE Emerging Economies Construction Dataset (the [EDGE Materials Embodied Energy](#) methodology report is available on the EDGE website). Embodied energy values can vary widely based on the assumptions made; using a standardized dataset ensures that each material is evaluated following the same methodology for a fair comparison in EDGE. To ensure consistency, EDGE does not allow the addition of a custom material.

MATERIALS EFFICIENCY MEASURES IN EDGE

MEMO1* – BOTTOM FLOOR CONSTRUCTION

Requirement Summary

This measure selection must be made, and the selected value must reflect the type of lowermost floor used in the project.

Intention

The intent is to reduce the embodied energy in the building by specifying floor types with lower embodied energy than a typical floor slab.

Approach/Methodologies

EDGE evaluates the embodied energy of the floor construction type by aggregating the impact of all the key materials such as concrete and any steel used in its construction per unit area. The thickness of the floor construction also determines the embodied energy per unit area. The design team must select the specification that matches or most closely resembles the bottom floor slab specified in the project and enter its thickness.

If there are multiple specifications, the predominant specification must be selected as the primary floor type. A second type of construction can also be indicated and marked with its percentage (%) area. The second type of construction needs to be indicated only if it represents more than 10% of the area; areas smaller than 10% are optional. If there are more than two types of construction, the smaller areas can be modeled as one of the two predominant types being modeled with which they match more closely.

In a multistoried building, the specification for the bottom floor slab must be that of the lowermost floor for the building, as this floor slab specification is often different from the typical intermediate floor slab and dictated by the ground conditions. The thickness must only include the structural slab. The thickness of the cement used to level the floor slab for the floor finish must not be included in this measure; this layer of screed is included in the embodied energy of the Floor Finish.

Potential Technologies/Strategies

Following is a list of the floor slab options included in EDGE. The user must always try to select the specification that most closely resembles that of the building design.

In-Situ Reinforced Concrete Slab	One of the most popular and conventional floor slab construction types, this floor slab uses Portland cement, sand, aggregate, water and reinforcing steel.
In-Situ Concrete with >25% GGBS	Same as above, but with >25% Portland cement replaced on a one-to-one basis by weight with ground granulated blast furnace slag (GGBS), a by-product of iron and steel manufacturing processes. Replacement levels of GGBS vary from 30% to up to 85% as applicable. Typically, 40% to 50% of GGBS is used.

MATERIALS EFFICIENCY MEASURES IN EDGE

<p>In-Situ Concrete with >30% PFA</p>	<p>Same as above, but with >30% Portland cement replaced by pulverized fuel ash (PFA), also known as fly ash, a waste product of coal fired at power stations. Using PFA as a cement replacement significantly reduces the overall carbon footprint of the concrete construction and helps to reduce risk of air and water pollution. In the promotion of environmental sustainability, PFA usage is one of the most highly recommended construction practices.</p>
<p>Concrete Filler Slab</p>	<p>Filler slab construction is technology based on the principal of using filler materials such as brick, clay tiles and cellular concrete blocks instead of concrete. The filler materials are used in the lower tensile region of the slab, which needs only enough concrete to hold the steel reinforcement together.</p> <p>Filler slab uses less concrete as well as steel due to the lightweight quality of the slab. It is also more cost-effective compared to conventional in-situ reinforced concrete slab.</p>
<p>Precast RC Planks and Joist System</p>	<p>This system uses precast concrete elements to construct intermediate floors and consists of (1) the plank, which represents smaller sections of the slab and is therefore of reduced thickness and reinforcement, and (2) the joist, which is a beam spanning across the room to provide a bearing for the planks. The planks are supported over partially precast RC joists which are set side by side and then joined together by pouring in-situ concrete over the entire roofing area. The monolithic action of the slab elements is enhanced by leaving reinforcement hooks projecting out of the joists and providing nominal reinforcement over the planks, before the in-situ concrete is poured. This method of construction saves time. Both elements of the floor – planks and joists – can also be manually produced at the site using wooden molds.</p>
<p>Concrete Filler Slab with Polystyrene Blocks</p>	<p>This system is like concrete filler slab technology in that one of the aims is to reduce the volume of concrete required, which is more cost-effective compared to conventional in-situ reinforced concrete slab. It is comprised of precast concrete beams, a polystyrene form which then stays in place in the lower tensile region of the slab, and in-situ concrete. This system can be installed with or without insulation. Adding insulation to the floor slabs when they are exposed to outdoor or unconditioned area helps to improve thermal performance for heat gain and loss. If Concrete Beam Vault with Insulation is selected, then the embodied energy due to the insulation is added to the floor slab in the Materials chart and not to the chart's insulation section.</p>
<p>In-Situ Trough Concrete Slab</p>	<p>This system is like concrete filler slab technology in that one of the aims is to reduce the volume of concrete required, which makes it more cost-effective compared to conventional in-situ reinforced concrete slab. It is comprised of in-situ concrete troughs formed using removable void formers cast into the lower tensile region of the slab. The void formers are removed on completion.</p>

MATERIALS EFFICIENCY MEASURES IN EDGE

In-situ Waffle Concrete Slab	<p>Same as above, except it is comprised of in-situ concrete waffles, instead of troughs, formed using removable void formers.</p>
Hollow Core Precast Slab	<p>Hollow-core floor planks are precast concrete elements with continuous longitudinal voids providing an efficient lightweight section. When grouted, the effective shear key between adjacent hollow-core planks ensures that the system behaves similarly to a monolithic slab. Hollow-core planks may be used to produce a diaphragm to resist horizontal forces, either with or without a structural topping. Hollow-core planks, supported on masonry or steel can be used in domestic, commercial and industrial applications.</p>
Composite Slim Floor Slabs with Steel I-beams	<p>A slim floor is a system of precast, hollow core concrete units or deep composite steel decking supported on modified steel beams in the form of an asymmetric section with a wider bottom flange or a flat steel plate welded to the bottom flange of a standard UKC section. The beam becomes partially encased within the floor depth, resulting in a structural system with no down-stand beams, which leads to reduced floor-to-floor heights. The floor slab supports in-situ concrete that is placed level with (or above) the top flange of the beam.</p>
Composite In-situ Concrete and Steel Deck (Permanent Shuttering)	<p>Composite slabs comprised of reinforced concrete cast on top of profiled steel decking acts as formwork during construction and external reinforcement at the final stage. Additional reinforcing bars may be placed in the decking troughs, particularly for deep decking. They are sometimes required in shallow decking when heavy loads are combined with high periods of fire resistance.</p>
Precast Concrete Double Tee Floor Units	<p>Double tee units reduce the number of pieces to erect and minimize the number of connections between beams and columns. Double tees provide a safe, unobstructed work platform, immediately after erection, that is usable for light construction loads. Reinforced, cast-in-place concrete topping over the double tees provides a leveling course, proper drainage slopes and a structural floor diaphragm.</p>
Thin Precast Concrete Deck and Composite In-situ Slab	<p>The most common type of composite beam is one where a composite slab sits on top of a downstand beam, connected by a through deck welded shear studs. This form of construction offers advantages: the decking acts as external reinforcement at the composite stage, and during the construction stage as formwork and a working platform. It may also provide lateral restraint to the beams during construction. The decking is lifted into place in bundles, which are then distributed across the floor area by hand. This dramatically reduces the crane lifts when compared with a precast based alternative.</p>
Timber Floor Construction	<p>Timber floor construction is generally supported on timber joists. These joists are rectangular sections of solid timber spaced at regular intervals, built into the external wall. The covering to the floor is generally timber floorboards or sheet chipboard. The finish to the underside is generally sheet plasterboard. Joist hangers have become very common as the method of supporting the joist,</p>

MATERIALS EFFICIENCY MEASURES IN EDGE

	avoiding building joists into walls. These are formed from galvanized steel and effectively form a shoe or seat for the joist to fit into, which is then built into the wall. They are also very useful for junctions between joists where previously a complicated carpentry joint would have been required.
Light Gauge Steel Floor Cassette	Pre-assembled sheet steel floor cassettes are manufactured off-site to stringent factory tolerances and can be bolted into the structure as a complete unit, providing a secure platform that can take a load straight away. This significantly speeds up the building process and ensures precise accuracy.
Re-use of Existing Floor Slab	Re-using an existing material avoids the use, and therefore embodied energy, of new materials. The re-use of the existing materials option in EDGE is highly desirable and is assigned an embodied energy value of zero. The material must be verifiably more than five years old to be classified as re-used. The material does not have to have been sourced from the project site.

Relationship to Other Measures

The contribution that the measure makes to the overall performance is not affected by any other measure.

Compliance Guidance

Design Stage	Post-Construction Stage
<p>At the design stage, the following must be used to demonstrate compliance:</p> <ul style="list-style-type: none"> • Floor sections showing the materials and thicknesses of the floor type(s); and • Building plans marking the area of major floor types if more than one type of floor is present; and • Manufacturer’s data sheets for the specified building materials; or • Bill of quantities with the floor slab specifications clearly highlighted. 	<p>At the post-construction stage, the following must be used to demonstrate compliance:</p> <ul style="list-style-type: none"> • Documents from the design stage if not already submitted. Include any updates made to the design stage documents to clearly reflect as-built conditions; and • Date-stamped photographs of the floor slabs taken during construction showing the claimed products on site; or • Purchase receipts showing the installed products. <p>Existing building projects</p> <ul style="list-style-type: none"> • If the documents required above are not available, other evidence of construction details, such as existing building drawings or photos taken during renovation can be submitted.

MATERIALS EFFICIENCY MEASURES IN EDGE

MEM02* – INTERMEDIATE FLOOR CONSTRUCTION

Requirement Summary

This measure selection must be made, and the selected value must reflect the type of floor used in the project.

Intention

The intent is to reduce the embodied energy in the building by specifying floor types with lower embodied energy than a typical floor slab.

Approach/Methodologies

EDGE evaluates the embodied energy of the floor construction type by aggregating the impact of all the key materials such as concrete and steel used in its construction per unit area. The thickness of the floor construction also determines the embodied energy per unit area. The design team must select the specification that matches or most closely resembles the floor slab specified in the project and enter its thickness.

If there are multiple specifications, the predominant specification must be selected as the primary floor type. A second type of construction can also be indicated and marked with its percentage (%) area. The second type of construction needs to be indicated only if it represents more than 10% of the area; areas smaller than 10% are optional. If there are more than two types of construction, the smaller areas can be modeled as one of the two predominant types being modeled with which they match more closely.

In a multistoried building, the specification for the floor slab must be that of the intermediary floor and not the ground floor, as the ground floor slab specification is often different from the typical and dictated by the ground conditions. The thickness must only include the structural slab. The thickness of the cement used to level the floor slab for the floor finish must not be included in this measure; this layer of screed is included in the embodied energy of the Floor Finish (MEM05).

Potential Technologies/Strategies

Following is a list of the floor slab options included in EDGE. The user must always try to select the specification that most closely resembles that of the building design.

In-Situ Reinforced Concrete Slab	One of the most popular and conventional floor slab construction types, this floor slab uses Portland cement, sand, aggregate, water and reinforcing steel.
In-Situ Concrete with >25% GGBS	Same as above, but with >25% Portland cement replaced on a one-to-one basis by weight with ground granulated blast furnace slag (GGBS), a by-product of iron and steel manufacturing processes. Replacement levels of GGBS vary from 30% to up to 85% as applicable. Typically, 40% to 50% of GGBS is used.

MATERIALS EFFICIENCY MEASURES IN EDGE

<p>In-Situ Concrete with >30% PFA</p>	<p>Same as above, but with >30% Portland cement replaced by pulverized fuel ash (PFA), also known as fly ash, a waste product of coal fired at power stations. Using PFA as a cement replacement significantly reduces the overall carbon footprint of the concrete construction and helps to reduce risk of air and water pollution. In the promotion of environmental sustainability, PFA usage is one of the most highly recommended construction practices.</p>
<p>Concrete Filler Slab</p>	<p>Filler slab construction is technology based on the principal of using filler materials such as brick, clay tiles and cellular concrete blocks instead of concrete. The filler materials are used in the lower tensile region of the slab, which needs only enough concrete to hold the steel reinforcement together.</p> <p>Filler slab uses less concrete as well as steel due to the lightweight quality of the slab. It is also more cost-effective compared to conventional in-situ reinforced concrete slab.</p>
<p>Precast RC Planks and Joist System</p>	<p>This system uses precast concrete elements to construct intermediate floors and consists of (1) the plank, which represents smaller sections of the slab and is therefore of reduced thickness and reinforcement, and (2) the joist, which is a beam spanning across the room to provide a bearing for the planks. The planks are supported over partially precast RC joists which are set side by side and then joined together by pouring in-situ concrete over the entire roofing area. The monolithic action of the slab elements is enhanced by leaving reinforcement hooks projecting out of the joists and providing nominal reinforcement over the planks, before the in-situ concrete is poured. This method of construction saves time. Both elements of the floor – planks and joists – can also be manually produced at the site using wooden molds.</p>
<p>Concrete Filler Slab with Polystyrene Blocks</p>	<p>This system is like concrete filler slab technology in that one of the aims is to reduce the volume of concrete required, which is more cost-effective compared to conventional in-situ reinforced concrete slab. It is comprised of precast concrete beams, a polystyrene form which then stays in place in the lower tensile region of the slab, and in-situ concrete. This system can be installed with or without insulation. Adding insulation to the floor slabs when they are exposed to outdoor or unconditioned area helps to improve thermal performance for heat gain and loss. If Concrete Beam Vault with Insulation is selected, then the embodied energy due to the insulation is added to the floor slab in the Materials chart and not to the chart's insulation section.</p>
<p>In-Situ Trough Concrete Slab</p>	<p>This system is like concrete filler slab technology in that one of the aims is to reduce the volume of concrete required, which makes it more cost-effective compared to conventional in-situ reinforced concrete slab. It is comprised of in-situ concrete troughs formed using removable void formers cast into the lower tensile region of the slab. The void formers are removed on completion.</p>

MATERIALS EFFICIENCY MEASURES IN EDGE

In-situ Waffle Concrete Slab	Same as above, except it is comprised of in-situ concrete waffles, instead of troughs, formed using removable void formers.
Hollow Core Precast Slab	Hollow-core floor planks are precast concrete elements with continuous longitudinal voids providing an efficient lightweight section. When grouted, the effective shear key between adjacent hollow-core planks ensures that the system behaves similarly to a monolithic slab. Hollow-core planks may be used to produce a diaphragm to resist horizontal forces, either with or without a structural topping. Hollow-core planks, supported on masonry or steel can be used in domestic, commercial and industrial applications.
Composite Slim Floor Slabs with Steel I-beams	A slim floor is a system of precast, hollow core concrete units or deep composite steel decking supported on modified steel beams in the form of an asymmetric section with a wider bottom flange or a flat steel plate welded to the bottom flange of a standard UKC section. The beam becomes partially encased within the floor depth, resulting in a structural system with no down-stand beams, which leads to reduced floor-to-floor heights. The floor slab supports in-situ concrete that is placed level with (or above) the top flange of the beam.
Composite In-situ Concrete and Steel Deck (Permanent Shuttering)	Composite slabs comprised of reinforced concrete cast on top of profiled steel decking acts as formwork during construction and external reinforcement at the final stage. Additional reinforcing bars may be placed in the decking troughs, particularly for deep decking. They are sometimes required in shallow decking when heavy loads are combined with high periods of fire resistance.
Precast Concrete Double Tee Floor Units	Double tee units reduce the number of pieces to erect and minimize the number of connections between beams and columns. Double tees provide a safe, unobstructed work platform, immediately after erection, that is usable for light construction loads. Reinforced, cast-in-place concrete topping over the double tees provides a leveling course, proper drainage slopes and a structural floor diaphragm.
Thin Precast Concrete Deck and Composite In-situ Slab	The most common type of composite beam is one where a composite slab sits on top of a downstand beam, connected by a through deck welded shear studs. This form of construction offers advantages: the decking acts as external reinforcement at the composite stage, and during the construction stage as formwork and a working platform. It may also provide lateral restraint to the beams during construction. The decking is lifted into place in bundles, which are then distributed across the floor area by hand. This dramatically reduces the crane lifts when compared with a precast based alternative.
Timber Floor Construction	Timber floor construction is generally supported on timber joists. These joists are rectangular sections of solid timber spaced at regular intervals, built into the external wall. The covering to the floor is generally timber floorboards or sheet chipboard. The finish to the underside is generally sheet plasterboard. Joist hangers have become very common as the method of supporting the joist,

MATERIALS EFFICIENCY MEASURES IN EDGE

	avoiding building joists into walls. These are formed from galvanized steel and effectively form a shoe or seat for the joist to fit into, which is then built into the wall. They are also very useful for junctions between joists where previously a complicated carpentry joint would have been required.
Light Gauge Steel Floor Cassette	Pre-assembled sheet steel floor cassettes are manufactured off-site to stringent factory tolerances and can be bolted into the structure as a complete unit, providing a secure platform that can take a load straight away. This significantly speeds up the building process and ensures precise accuracy.
Re-use of Existing Floor Slab	Re-using an existing material avoids the use, and therefore embodied energy, of new materials. The re-use of the existing materials option in EDGE is highly desirable and is assigned an embodied energy value of zero. The material must be verifiably more than five years old to be classified as re-used. The material does not have to have been sourced from the project site.

Relationship to Other Measures

The contribution that the measure makes to the overall performance is not affected by any other measure.

Compliance Guidance

Design Stage	Post-Construction Stage
<p>At the design stage, the following must be used to demonstrate compliance:</p> <ul style="list-style-type: none"> • Floor sections showing the materials and thicknesses of the floor(s); and • Building plans marking the area of major floor types if more than one type of floor is present; and • Manufacturer’s data sheets for the specified building materials; or • Bill of quantities with the floor slab specifications clearly highlighted. 	<p>At the post-construction stage, the following must be used to demonstrate compliance:</p> <ul style="list-style-type: none"> • Documents from the design stage if not already submitted. Include any updates made to the documents to clearly reflect As-Built conditions; and • Date-stamped photographs of the floor slabs taken during construction showing the claimed products on site; or • Purchase receipts showing the installed products. <p>Existing building projects</p> <ul style="list-style-type: none"> • If the documents required above are not available, other evidence of construction details, such as existing building drawings or photos taken during renovation can be submitted.

MATERIALS EFFICIENCY MEASURES IN EDGE

MEM03* – FLOOR FINISH

Requirement Summary

This measure selection must be made, and the selected value must reflect the type of floor finish used in the project.

Intention

The intent is to reduce the embodied energy in the building by specifying floor finishes with lower embodied energy than a typical floor finish.

Approach/Methodologies

The floor finish includes the topmost layer of finishing material, as well as any layers used to install it on the floor slab, such as underlayment and glue or the leveling layer of cement known as screed.

EDGE evaluates the embodied energy of the floor finish by aggregating the impact of all the key materials per unit area. The thickness of the floor finish also determines the embodied energy per unit area. The design team must select the specification that matches or most closely resembles the floor finish specified in the project and enter its thickness.

If there are multiple specifications, the predominant specification must be selected as the primary floor finish type. A second type of construction can also be indicated and marked with its percentage (%) area. The second type of construction needs to be indicated only if it represents more than 10% of the area; areas smaller than 10% are optional. If there are more than two types of construction, the smaller areas can be modeled as one of the two predominant types being modeled with which they match more closely.

Potential Technologies/Strategies

The following is a list of the specifications included in EDGE. The user must always try to select the specification that most closely resembles that of the building design.

Ceramic Tile	The advantage of tiles is that they are hard wearing, which minimizes the maintenance required. However, tiles are not maintenance free, as the grout requires maintenance. The manufacture of tiles uses large amounts of energy due to the firing required and therefore tiles have a high embodied energy.
Vinyl Flooring	Vinyl flooring is water resistant, low maintenance and inexpensive. It is easy to install and is durable. However, vinyl flooring has a high embodied energy and can release harmful volatile organic compounds after installation. Although durable, vinyl flooring must be laid on a flat, smooth surface. An uneven surface might cause wearing and holes which are difficult to repair, as vinyl is usually laid in a single piece.

MATERIALS EFFICIENCY MEASURES IN EDGE

Stone Tiles/Slabs	<p>Stone tiles can often be sourced locally and have low embodied energy compared to some man-made materials. However, machine cut and polished stone tiles can be higher in embodied energy relative to other natural materials and can be expensive.</p>
Finished Concrete Floor	<p>More commonly referred to as "screed," cement plaster is often used as a preparation layer for soft or flexible floor finishes or tiles. Cement plaster can be used as a finish layer, but it can be chipped more easily than other hard flooring options.</p>
Linoleum Sheet	<p>Linoleum, often referred to as lino, is a floor covering made from solidified linseed oil (linoxyn), pine rosin, ground cork dust, wood flour and mineral fillers such as calcium carbonate. These materials are added to a canvas backing; pigments are often added to the materials. Lino can be used as an alternative to vinyl and has a much lower embodied energy.</p>
Terrazzo Tiles	<p>Terrazzo tiles are a hard-wearing option for flooring which require very little maintenance. Terrazzo floors can be laid in situ by pouring concrete or resin with granite chips and then polishing the surface. Alternatively, terrazzo tiles are manufactured in a factory before being laid onsite.</p>
Nylon Carpets	<p>Most nylon carpets have a very high embodied energy because of the large amount of energy used in their manufacture but also because nylon is made from oil. Nylon carpets have good acoustic properties and help to reduce reverberation times as well as the transfer of impact sound.</p>
Laminated Wooden Flooring	<p>Laminated wooden flooring is more dimensionally stable than solid wood flooring so it can be used in rooms prone to changes in moisture levels or where underfloor heating is used. Due to the thickness of the finish layer the number of times that it can be refinished is reduced, but the initial capital cost is lower than for solid wood flooring.</p>
Terracotta Tiles	<p>Terracotta is fine-grained, orange or reddish-brown fired clay that is used for several construction and decorative purposes, primarily roof and floor tiles. The name comes from Italian, which means "baked earth," as it is cooked or fired earth or soil.</p> <p>The color varies slightly depending on the clay used. It is waterproof and a very sturdy material. Its durability and resistance to both fire and water make it an ideal building material. It is also lighter than stone, and it can be glazed for extra durability or to provide a wide variety of colors, including finishes that resemble stone or metal patina. Terracotta is a relatively inexpensive material.</p>

MATERIALS EFFICIENCY MEASURES IN EDGE

Parquet/Wood Block Finishes	<p>Parquet is wood block flooring in a geometric pattern. It is available in either solid or engineered construction, both of which can be manufactured to have an aged, rustic appearance. Solid parquet wood flooring is more traditional. Engineered wood flooring is composed of layers with a wood species forming the top flooring surface, and two or more under layers of wood running at 90° to each other. The crisscrossed layers increase stability which enables the product to be installed over all types of sub floors and to be used with underfloor heating.</p>
Plant Fiber (Seagrass, Sisal, Coir or Jute) Carpet	<p>Natural flooring has low embodied energy, but it has some disadvantages. It can be sensitive to changes in environment or atmosphere; the product may expand or shrink if fitted in an area such as a bathroom or kitchen where there is a constant change in temperature. Natural fiber flooring may also stain easily. Also, grass contains its own natural oils which makes it slippery on stairs. It's also not as hardwearing as other natural-fiber floorings such as sisal or coir.</p>
Cork Tiles	<p>Cork has low embodied energy and is environmentally friendly. It can be harvested from the same tree for about two hundred years. Harvesting is done with minimal impact on the environment and no trees are cut down to manufacture cork products. Advanced coating technology provides highly resistant and long-lasting protection even in high traffic environments.</p>
Re-use of Existing Flooring	<p>Re-using an existing material avoids the use, and therefore embodied energy, of new materials. The re-use of existing materials option in EDGE is highly desirable and assigned an embodied energy value of zero. The material must be verifiably more than five years old to be classified as re-used. The material does not have to have been sourced from the project site.</p>

Relationship to Other Measures

Although flooring does not affect other measures in EDGE it can impact acoustic performance.

MATERIALS EFFICIENCY MEASURES IN EDGE

Compliance Guidance

Design Stage	Post-Construction Stage
<p>At the design stage, the following must be used to demonstrate compliance:</p> <ul style="list-style-type: none">• Drawings showing the flooring specifications selected; and• Building plans highlighting the area of major flooring types if more than one type of flooring is present; and• Manufacturer’s data sheets for the specified building materials; or• Bill of quantities with the specifications for the flooring materials clearly highlighted.	<p>At the post-construction stage, the following must be used to demonstrate compliance:</p> <ul style="list-style-type: none">• Documents from the design stage if not already submitted. Include any updates made to the documents to clearly reflect As-Built conditions; and• Date-stamped photographs of the flooring during or after installation showing the claimed products on site; or• Purchase receipts showing the installed products. <p>Existing building projects</p> <ul style="list-style-type: none">• If the documents required above are not available, other evidence of construction details, such as existing building drawings or photographs can be submitted.

MATERIALS EFFICIENCY MEASURES IN EDGE

MEM04* – ROOF CONSTRUCTION

Requirement Summary

This measure selection must be made, and the selected value must reflect the type of roof used in the project.

Intention

The intent is to reduce the embodied energy in the building by specifying roof types with lower embodied energy than a typical roof slab.

Approach/Methodologies

EDGE evaluates the embodied energy of the roof construction by aggregating the impact of all the key materials such as concrete and steel used in its construction per unit area. The thickness of the roof construction also determines the embodied energy per unit area. The design team must select the specification that matches or most closely resembles the roof type specified in the project and enter its thickness.

If there are multiple specifications, the predominant specification must be selected as the primary roof type. A second type of construction can also be indicated and marked with its percentage (%) area. The second type of construction needs to be indicated only if it represents more than 10% of the area; areas smaller than 10% are optional. If there are more than two types of construction, the smaller areas can be modeled as one of the two predominant types being modeled with which they match more closely.

In the Energy tab, a weighted average must be used for specifications such as solar reflectivity and U-value. This applies for green roofs as well. To specify a green roof, adjust these values in the Energy tab: (1) reflectivity of the roof (use the default of 70% if actual value is not available) and (2) insulation of the roof (U-value) to define the green roof condition. In the Materials tab, under roof insulation, select the insulation type used in the roof assembly.

The thickness must only include the structural roof. The thickness of any air space or ceiling below the roof must not be included in this measure. Similarly, any layer of material that is raised above the roof with open air in between, such as a metal shading structure, must not be included in the roof materials and thickness.

Potential Technologies/Strategies

The following is a list of specifications included in EDGE. The user should always try to select the specification that most closely resembles that of the building design.

In-Situ Reinforced Concrete Slab	One of the most popular and conventional of all roof construction types, in-situ reinforced concrete slab uses Portland cement, sand, aggregate, water and reinforcing steel.
In-Situ Concrete with >25% GGBS	Ground granulated blast furnace slag (GGBS) is obtained by quenching molten iron slag (a by-product of iron and steel making) from the blast furnace in water or steam, producing a glassy, granular product which is then dried and ground into a

MATERIALS EFFICIENCY MEASURES IN EDGE

	<p>fine powder. The roof construction technology for GGBS is the same as for the in-situ reinforced concrete slab but the Portland cement is directly replaced by industrial waste (GGBS) on a one-to-one basis by weight. Replacement levels of GGBS vary from 30% to up to 85% as applicable. In most instances, typically 40% to 50% of GGBS is used. Since the manufacture of Portland cement is energy intensive, replacing it with GGBS helps to reduce high-embodied energy content. Using GGBS also helps to reduce air and water pollution, leading to a more sustainable slab construction practice.</p>
<p>In-Situ Concrete with >30% PFA</p>	<p>Pulverized fuel ash (PFA), also known as fly ash, is a waste product of coal fired power stations. Using PFA as a cement replacement significantly reduces the overall carbon footprint of the concrete construction and helps to reduce risk of air and water pollution. In the promotion of environmental sustainability, PFA usage is one of the most highly recommended construction practices.</p>
<p>Concrete Filler Slab</p>	<p>Filler slab construction is technology based on the principal of using filler materials such as brick, clay tiles and cellular concrete blocks instead of concrete. The filler materials are used in the lower tensile region of the slab, which needs only enough concrete to hold the steel reinforcement together.</p>
<p>Precast RC Planks and Joist System</p>	<p>This system uses precast concrete elements to construct a roof and consists of two elements:</p> <p>The plank, which represents smaller sections of the slab and is therefore of reduced thickness and reinforcement, and</p> <p>The joist, which is a beam spanning across the room to provide a bearing for the planks. The joist is partially precast, with the remaining portion being cast in-situ after the planks are installed.</p> <p>The monolithic action of the slab elements is enhanced by leaving reinforcement hooks projecting out of the joists and providing nominal reinforcement over the planks, before the in-situ concrete is poured. The planks are supported over partially precast RC joists which are set side by side and then joined together by pouring in-situ concrete over the entire roofing area. Both elements of the roof – planks and joists – can be manually produced at the site using wooden molds. This method of construction saves time.</p>
<p>Concrete Filler Slab with Polystyrene Blocks</p>	<p>This system is like concrete filler slab technology in that one of the aims is to reduce the volume of concrete required, which is more cost-effective compared to conventional in-situ reinforced concrete slab. It is comprised of precast concrete beams, a polystyrene form which then stays in place, in the lower tensile region of the slab and in-situ concrete. This system can be installed with or without insulation. Adding insulation to the roof slabs helps to improve thermal performance for heat gain and loss. If Concrete Beam Vault with Insulation is selected in the Materials section, the embodied energy due to the insulation is added to the roof slab and not to the insulation.</p>

MATERIALS EFFICIENCY MEASURES IN EDGE

In-Situ Trough Concrete Slab	<p>This system is like concrete filler slab technology in that one of the aims is to reduce the volume of concrete required, which is more cost-effective compared to conventional in-situ reinforced concrete slab. It is comprised of in-situ concrete troughs formed using removable void formers cast into the lower tensile region of the slab. The void formers are removed on completion.</p>
In-Situ Waffle Concrete Slab	<p>Same as above, except it is comprised of in-situ concrete waffles, instead of troughs, formed using removable void formers.</p>
Hollow Core Precast Slab	<p>Hollow core planks are precast concrete elements with continuous longitudinal voids providing an efficient lightweight section. When grouted, the effective shear key between adjacent hollow core planks ensures that the individual planks behave similarly to a monolithic slab. Hollow core planks may be used to produce a diaphragm to resist horizontal forces, either with or without a structural topping. Hollow core planks, supported on masonry or steel, can be used in domestic, commercial and industrial applications.</p>
Composite Slim Slabs with Steel I-beams	<p>A slim roof beam is a modified steel section in the form of a rolled asymmetric section (ASB beam) or a flat steel plate welded to the bottom flange of a standard UKC section. The bottom plate supports the slab so that the beam is partially encased within the slab depth, resulting in a structural system with no down-stand beams, which leads to reduced floor-to-floor heights. The slab may be in the form of precast, hollow core concrete units or deep composite steel decking, in both cases supporting in-situ concrete that is placed level with (or above) the top flange of the beam.</p>
Composite In-situ Concrete and Steel Deck (Permanent Shuttering)	<p>Composite slabs comprise reinforced concrete cast on top of profiled steel decking, which acts as formwork during construction and external reinforcement at the final stage. Additional reinforcing bars may be placed in the decking troughs, particularly for deep decking. They are sometimes required in shallow decking when heavy loads are combined with high periods of fire resistance.</p>
Precast Concrete Double Tee Roof Units	<p>Combined beam/column frame units reduce the number of pieces to erect and minimize the number of connections between beams and columns. Double tees provide a safe, unobstructed work platform, immediately after erection, that is usable for light construction loads. Reinforced, cast-in-place concrete topping over the double tees provides a leveling course, proper drainage slopes and a structural roof diaphragm.</p>
Thin Precast Concrete Deck and Composite In-situ Slab	<p>This construction technique utilizes a composite beam that is a structural beam composed of different materials that are interconnected so that the beam responds to loads as a unit. The most common type of composite beam is one where a steel-concrete composite slab sits on top of a downstand beam, connected by the use of through-deck welded shear studs. This form of construction offers a number of advantages: the decking acts as external reinforcement at the composite stage, and during the construction stage as</p>

MATERIALS EFFICIENCY MEASURES IN EDGE

	formwork and a working platform. It may also provide lateral restraint to the beams during construction. The decking is lifted into place in bundles, which are then distributed across the roof area by hand. This dramatically reduces the crane lifts when compared with a precast alternative.
Brick Panel Roofing System	A brick roofing panel is made of first-class bricks reinforced with two mild steel bars of 6mm diameter. The joints between panels are filled with either 1:3 cement sand mortar or M15 concrete. The panels can be made in any size, but are typically 530mm x 900mm or 530mm x 1,200mm, depending on the requirements. The recommended maximum length is 1,200 mm.
Ferro Cement Roofing Channels	Ferro cement is a thin layer of reinforced cement, made of layers of continuous mesh covered on both sides with mortar. Ferro cement elements are durable, versatile, light and waterproof. They are not good thermal insulators. A ferro cement channel (FC) is a longitudinal element of a curved section (often semi-cylindrical). It is precast using moulds. It uses less cement and steel but has the same strength as RCC (reinforced cement concrete). This system is cheaper than RCC. Although it is easy to learn and to manufacture, constant quality control is needed during the manufacturing process.
Clay Roofing Tiles on Steel Rafters	With this type of roof construction, clay tiles are laid on steel rafters. Steel rafters ensure durability and strength but the embodied energy content of steel is higher than that of timber rafters, which need maintenance but have less embodied energy. EDGE estimates the embodied energy based on a thickness of 10mm for the clay roofing tiles and 8mm for the steel or timber rafters.
Clay Roofing Tiles on Timber Rafters	Same as above, except with timber rafters instead of steel rafters. Timber rafters need maintenance but have less embodied energy than steel. Timber sourced from a responsible forest management agency or from re-growth forests ensures the protection and conservation of natural forest communities.
Micro Concrete Tiles on Steel Rafters	Micro Concrete Roofing (MCR) Tiles are a cost-effective, aesthetic and durable alternative sloping roof technology. They have less embodied energy content than clay roof tiles and, as MCR tiles are lighter than other roofing tiles, they can be laid on a lighter weight structure.
Micro Concrete Tiles on Timber Rafters	Same as above, except on timber rafters.
Steel (Zinc or Galvanized Iron) Sheets on Steel Rafters	Zinc is a very dense and corrosion-resistant architectural material. It is non-ferrous, thus not subject to rusting. Its manufacturing includes crushing the zinc ore into particles, which are then concentrated by floatation. Then they are cast on a continuously rotating cylinder and rolled through pressure rolls to a specified thickness. They are often used as vertical cladding or on pitched roofs.

MATERIALS EFFICIENCY MEASURES IN EDGE

	Corrugated zinc sheets are widely used for roofs as they are easy to install due to being prefabricated; also, they are cheap and very light. The corrugations increase the bending strength of the sheet in the direction perpendicular to the corrugations, but not parallel to them.
Steel (Zinc or Galvanized iron) Sheets on Timber Rafters	Same as above, but on timber rafters.
Aluminum Sheets on Steel Rafters	Besides steel, aluminum is the most used metal in construction. It is one of the lightest and easiest metals to manipulate, bend, shape, cast, fasten and weld, and is also very ductile, often extruded into shapes for architectural purposes. It can easily be drilled, tapped, sawed, planed and filed with hand tools, making it a yielding material for tradesmen to use. Aluminum has higher resistance to corrosion than steel. However, disadvantages include higher cost and embodied energy, greater thermal expansion, and lower fire resistance than steel.
Aluminum Sheets on Timber Rafters	Same as above, but on timber rafters.
Copper Sheets on Steel Rafters	When properly designed and installed, a copper roof provides an economical, long-term roofing solution. Its low life cycle costs are attributable to the low maintenance, long life and salvage value of copper. Unlike many other metal roofing materials, copper requires no painting or finishing.
Copper Sheets on Timber Rafters	Same as above, but on timber rafters.
Asphalt Shingles on Steel Rafters	Asphalt shingles are an effective roof covering material for sloped roofs. They can be successfully used on steeper pitches as well as moderately "low sloped" roofs (less than 1:3 i.e.100mm of vertical rise for every 300mm of horizontal run, or 18.5°), providing a few special application procedures are followed for low slopes. They should not be applied to roof slopes lower than 1:6.
Asphalt Shingles on Timber Rafters	Same as above, but on timber rafters.
Aluminum-clad Sandwich Panel	Sandwich panels provide a combination of high structural rigidity and low weight and are used in a variety of applications. An aluminum-clad sandwich panel is made of three layers: a low-density core with a thin skin-layer of aluminum bonded to each side. The core may be empty or honeycombed and may contain insulation.
Steel-clad Sandwich Panel	Sandwich panels provide a combination of high structural rigidity and low weight and are used in a variety of applications. A steel-clad sandwich panel is made of three layers: a low-density core with a thin skin-layer of steel bonded to each side. The core may be empty or honeycombed and may contain insulation. Steel is

MATERIALS EFFICIENCY MEASURES IN EDGE

	stronger than aluminum, so there is less likelihood of the core being honeycombed for strength.
Re-use of Existing Roof	Re-using an existing material avoids the use, and therefore embodied energy, of new materials. The re-use of existing materials option in EDGE is highly desirable and assigned an embodied energy value of zero. The material must be verifiably more than five years old to be classified as re-used. The material does not have to have been sourced from the project site.

Relationship to Other Measures

The selected roof specification will impact the thermal insulation of the roof surface, so the energy efficiency could be adversely affected or improved by selecting different roof specifications.

Compliance Guidance

Design Stage	Post-Construction Stage
<p>At the design stage, the following must be used to demonstrate compliance:</p> <ul style="list-style-type: none"> • Roof sections showing the materials and thicknesses of the roof(s); and • Building plans marking the area of major roof types if more than one type of roof is present; and • Manufacturer’s data sheets for the specified building materials; or • Bill of quantities with the roof material specifications clearly highlighted. 	<p>At the post-construction stage, the following must be used to demonstrate compliance:</p> <ul style="list-style-type: none"> • Documents from the design stage if not already submitted. Include any updates made to the documents to clearly reflect As-Built conditions; and • Date-stamped photographs of the roof(s) taken during construction showing the claimed products on site; or • Purchase receipts showing the installed products. <p>Existing building projects</p> <ul style="list-style-type: none"> • If the documents required above are not available, other evidence of construction details, such as existing building drawings or photos taken during renovation can be submitted.

MATERIALS EFFICIENCY MEASURES IN EDGE

MEM05* – EXTERIOR WALLS

Requirement Summary

This measure selection must be made, and the selected value must reflect the type of exterior wall used in the project.

Intention

The intent is to reduce the embodied energy in the building by specifying exterior wall types with lower embodied energy than a typical exterior wall.

Approach/Methodologies

The exterior walls of the building are those directly exposed to the outdoor environment.

EDGE evaluates the embodied energy of the wall construction type by aggregating the impact of all the key materials such as brick and plaster or gypsum board used in its construction per unit area. The thickness of the wall also determines the embodied energy per unit area. The design team must select the specification that matches or most closely resembles the exterior wall specified in the project and enter its thickness.

If there are multiple specifications, the predominant specification must be selected as the primary exterior wall type. A second type of construction can also be indicated and marked with its percentage (%) area. The second type of construction needs to be indicated only if it represents more than 10% of the area; areas smaller than 10% are optional. If there are more than two types of construction, the smaller areas can be modeled as one of the two predominant types being modeled with which they match more closely.

Potential Technologies/Strategies

The following is a list of the specifications included in EDGE. Only the broad wall types are described here; EDGE does not include options on plaster or finishing. The user should always try to select the specification that most resembles that of the building design.

Common Brick Wall with Internal & External Plaster	Common bricks, also known as fired clay bricks, are popular with builders as they are easily available and inexpensive. However, because common bricks are fired at high temperatures, normally achieved by the combustion of fossil fuels, they have high embodied energy.
Cored (with Holes) Bricks with Internal & External Plaster	Cored clay blocks are made of fired clay and have a holed cross-section. The holed structure means that there is less material per square meter of finished wall.
Honeycomb Clay Blocks with	Honeycomb clay blocks are made of fired clay and have a honeycombed cross-section. The large size of the blocks enables rapid construction, and the honeycomb structure means that there is less material per square meter of finished wall. The honeycomb structure leads

MATERIALS EFFICIENCY MEASURES IN EDGE

Internal & External Plaster	to improved thermal performance. Blocks can be customized. No mortar is needed in the vertical joints due to a tongue and grooved edge, reducing mortar use by up to 40%. The blocks are strong and have a high impact resistance. Honeycomb clay blocks have post-consumer value if dismantled carefully.
Medium Weight Hollow Concrete Blocks	Hollow concrete blocks are lightweight and easier to handle than solid concrete blocks. The lightness of the blocks helps in reducing the dead load of the masonry on the structure. The voids also marginally improve the thermal insulation and sound insulation of the block. The larger size of the blocks (compared to conventional burnt clay bricks) also reduces the number of mortar joints and the amount of cement mortar.
Solid Dense Concrete Blocks	Solid dense concrete blocks can be used in virtually any part of a building. They provide excellent sound insulation and their high strength makes them applicable for use in structural walls. However, the use of virgin aggregates and sand can lead to land or marine degradation and resource depletion, and the lack of supplementary materials in the cement results in increased embodied energy.
Autoclaved Aerated Concrete Blocks	<p>Aerated concrete is a versatile, lightweight building material. Compared to solid dense concrete blocks, aerated concrete blocks have a lower density and excellent insulation properties. They are durable and have good resistance to sulfate attack and damage by fire and frost. Aerated concrete blocks are excellent thermal insulators.</p> <p>Based on volume, the manufacture of aerated blocks typically uses 25% less energy than other concrete blocks. They are lighter in weight which makes them easier to work with and saves energy in transportation.</p>
Fly-Ash Stabilized Soil Blocks	<p>Soil blocks have some inherent weaknesses that can be corrected using stabilization materials like fly ash or ground granulated blast furnace slag (GGBFS).</p> <p>Fly ash usually refers to industrial waste produced during coal combustion.</p>
Compressed Stabilized Earth Blocks	Stabilized Compressed Earth Block (SCEB) technology offers a cost-effective and environmentally-friendly alternative to conventional building materials. The blocks are fire-resistant, provide better thermal insulation, and do not need to be fired, so they have a lower embodied energy.
Ground Granulated Blast (GGBS) Stabilized Soil Blocks	GGBFS is a by-product of the iron industry. The molten slag is cooled rapidly with water and is then ground into a fine cementations powder. GGBFS can then be used as a cement replacement in the blocks.
Rammed Earth Blocks/Walls	Rammed earth walls are more commonly used in arid areas. They are constructed by the compacting (ramming) of moistened subsoil into place between temporary formwork panels. When dried, the result is a dense, hard monolithic wall. As an alternative, rammed earth bricks are also available. The high moisture mass of rammed earth helps regulate humidity.

MATERIALS EFFICIENCY MEASURES IN EDGE

<p>Precast Concrete Panels</p>	<p>Precast concrete is a construction product made by casting concrete in a reusable molding or “form” which is then cured in a controlled environment, transported to the construction site, and lifted into place.</p> <p>Precast cladding or curtain walls are the most common use of precast concrete for building envelopes. These types of precast concrete panels do not transfer vertical loads but simply enclose the space. They are only designed to resist wind, seismic forces generated by their own weight, and forces requiring transferring the weight of the panel to the support. Common cladding units include wall panels, window wall units, spandrels, mullions and column covers. These units can usually be removed individually if necessary.</p> <p>In some cases, precast panels are used as formwork for cast-in-place concrete. The precast panels act as a form, providing the visible aesthetics of the system, while the cast-in-place portion provides the structural component.</p>
<p>Straw Bale Blocks</p>	<p>Straw bale blocks are a rapidly renewable building material made from the dry stalk left in the earth after harvest, which is traditionally considered a waste product that is burned or baled and sold for animal use. It is a natural, non-toxic building material with low environmental impact and excellent insulation properties. Since it is very easy to work with it is a good choice for amateur or unskilled self-builders.</p> <p>Straw bale houses are finished and coated with cement stucco or earth-based plaster, sealing the straw from the elements and giving long-lasting protection with little maintenance. In contrast to the timber used for wood framing, straw can be grown in less than a year in a completely sustainable production system. The conversion of straw into a sustainable renewable resource to be used as a dominant building material could be especially beneficial in areas where the climate is severe and timber is scarce, but straw is plentiful.</p>
<p>Facing Brick and Timber Stud</p>	<p>Timber stud walls are a lightweight construction technique which reduces the dead load of building and increases the pace of construction. Timber has relatively high embodied energy. Timber for stud walls should be made from local forest-department-certified wood or a forest-stewardship-council-certified wood, which helps to avoid the use of virgin wood for building construction activities.</p>
<p>Phosphogypsum Panel</p>	<p>Phosphogypsum is a waste product of the fertilizer industry. The use of Phosphogypsum board in buildings is a substitute for natural gypsum.</p>
<p>Ferrocement Wall Panel</p>	<p>Ferrocement is a very simple construction of 2 to 5 layers of chicken wire over a frame made from reinforcing bar, with cement forced into the gaps and in a layer over the chicken wire reinforcing. The use of chicken wire makes ferrocement a very flexible building material that is strongest when curved.</p>
<p>In-Situ Reinforced Wall</p>	<p>More commonly used for floor slabs and roofs, in-situ reinforced concrete is also used to construct external walls. It has a high embodied energy due to the inclusion of Portland cement and uses sand, aggregate, water and reinforcing steel.</p>

MATERIALS EFFICIENCY MEASURES IN EDGE

<p>Cellular Light Weight Concrete Blocks</p>	<p>These blocks, which are environmentally friendly, are also called CLC blocks. The energy consumed in the production is only a fraction compared to the production of clay bricks. They are made from a slurry of cement, fly ash* and water, which is further mixed with the addition of pre-formed stable foam in an ordinary concrete mixer under ambient conditions.</p> <p>The addition of foam to the concrete mixture creates millions of tiny voids or cells in the material, hence the name Cellular Concrete.</p> <p>*Fly ash is a waste material from thermal power plants.</p>
<p>Stone Blocks</p>	<p>Limestone makes up about 10% of the total volume of all sedimentary rocks. Although limestone is found widely, developers and designers should opt for local extracted stone to reduce transport implications.</p> <p>Limestone is readily available and relatively easy to cut into blocks in a quarry. It is also long-lasting and stands up well to exposure, as it is hard, durable and commonly occurs in easily accessible surface exposures. Because of its mass, it has a high thermal inertia.</p> <p>However, limestone is a very heavy material, making it impractical for tall buildings, and relatively expensive as a building material.</p>
<p>Stone Blocks – Hand Cut</p>	<p>Same as above, except hand-cut and not polished. The embodied energy is in the extraction process and heavy transportation loads.</p>
<p>Stone Blocks – Machine Cut Unpolished</p>	<p>Quarried stone, machine-cut and not polished. The quarried stone is typically of medium hardness between limestone and granite. The embodied energy is in the extraction process and cutting with a mechanized saw.</p>
<p>FaLG Block</p>	<p>The Fly Ash-Lime-Gypsum blocks technology primarily uses industrial wastes such as fly ash (from thermal power plants), lime gypsum (from fertilizer industries), and sand (optional) to produce alternative walling materials. It reduces the environmental impacts associated with disposal of these industrial wastes, as well as avoids the environmental impacts associated with clay brick production, such as denudation of fertile topsoil. As the process for FAL-G blocks does not require sintering, the amount of energy (fossil fuels) for production is reduced.</p> <p>The manufacturing process consists of three main stages:</p> <ul style="list-style-type: none"> - Mixing the materials: Fly ash is mixed with lime and gypsum. Chemical accelerator may or may not be added to it. - Pressing the mix in a machine: the mix is molded under pressure, also air/ sun drying may be undertaken; and - Curing the blocks for a stipulated period: the green block is water cured. <p>In the presence of moisture, fly ash reacts with lime at ordinary temperature and forms a compound possessing cementations properties. After reactions between lime and fly ash, calcium silicate hydrates are produced which are responsible for the high strength of the compound.</p>

MATERIALS EFFICIENCY MEASURES IN EDGE

	<p>Generally, FAL-G blocks are gray in color, solid and have plain rectangular faces with parallel sides and sharp, straight and right-angled edges. They are used for the development of infrastructure, construction of pavements, dams, tanks and under water works.</p>
<p>Steel Profile Cladding</p>	<p>Steel, one of the strongest and most affordable materials, is a ferrous metal, meaning it contains iron. It has a favorable strength-to-weight ratio as well as provides elasticity. Other benefits include stiffness and fire and corrosion resistance.</p> <p>Steel wall cladding profiles create totally new economical solutions in both new building and renovation and in operating and maintenance. The profiles are versatile cladding that comes in a very broad range of shapes, finishing and colors that enable innovative designs. In addition, they can be installed with insulation for better thermal performance.</p>
<p>Aluminum Profile Cladding</p>	<p>Beside steel, aluminum is the most used metal in construction. It is one of the lightest and easiest metals to manipulate, bend, shape, cast, fasten and weld, and is also very ductile, often extruded into shapes for architectural purposes. It can easily be drilled, tapped, sawed, planed and filed with hand tools, making it a yielding material for tradesmen to use.</p> <p>Aluminum is commonly used as wall cladding or curtain-walls, as its resistance to corrosion is higher than steel, and lighter than other metals. However, the disadvantages are the higher cost and embodied energy, greater thermal expansion, and lower fire resistance as compared to steel.</p> <p>Most exterior applications using aluminum alloys are anodized surfaces, which increases the metal durability, traps dyes and adheres to other finishes. Plastic coatings, which are applied electrostatically as a powder and then heat cured, are also used for cladding wall panels. This coating gives a durable protection layer, with a more uniform appearance.</p> <p>The finished appearance can range from clear to a wide variety of colors and textures, depending on the coating applied. In addition, the panels can be installed with insulation for better thermal performance.</p>
<p>Exposed Brick Wall with Internal Plaster</p>	<p>Same as brick wall, except with no external plaster. Common bricks are fired at high temperatures, normally achieved by the combustion of fossil fuels, and therefore have high embodied energy.</p>
<p>Exposed Cored (with Holes) Bricks with Internal Plaster</p>	<p>Same as cored brick wall, except with no external plaster.</p>
<p>Facing Brick and Hollow Concrete Blocks</p>	<p>Facing bricks are bricks made of fired clay and used as the exterior face of a wall. Hollow concrete blocks are used as the inner layer of the wall. They are lightweight and easier to handle than solid concrete blocks. The lightness of the blocks helps in reducing the dead load of the masonry on the structure. The voids also marginally improve the thermal insulation and sound insulation of the block. The larger size of the blocks (compared to</p>

MATERIALS EFFICIENCY MEASURES IN EDGE

	conventional burnt clay bricks) also reduces the number of mortar joints and the amount of cement mortar.
Facing Brick and Solid Concrete Blocks	Same as above, except with solid concrete blocks instead of hollow concrete blocks. Their high strength makes them applicable for use in structural walls. However, the use of virgin aggregates and sand can lead to land or marine degradation and resource depletion, and the lack of supplementary materials in the cement results in increased embodied energy.
Polymeric Render on Concrete Block	The exterior layer is made of polymeric render. Polymer render is a dry premixed polymer and fiber-reinforced powder applied to precast concrete blocks. Requiring only a single coat, polymer render is weather tight when cured, but will freely allow transmission of water vapor. The render is both breathable and flexible. Life expectancy is often more than 30 years. The inside layer is made of concrete blocks.
Polymeric Render on Brick	Same as above, except the inner layer is brick. Because common bricks are fired at high temperatures, normally achieved by the combustion of fossil fuels, they have high embodied energy.
Precast Concrete Sandwich Panel	Precast concrete sandwich panels comprise an outer leaf of precast concrete, an insulating layer "sandwiched" in between, and an inner leaf of plain gray concrete with a power floated finish. The panels may be attached to a steel frame as a cladding panel, or they can form part of a precast structural frame where the inner leaf is load bearing and the external leaf is connected to and supported off the internal leaf using ties. The ties used in the precast structural frames are made of metal, plastic or epoxy and have low thermal conductivity to eliminate cold bridging. The thickness of the insulation depends on the required U-value. The shape, thickness and size of the concrete can be varied to meet the requirements of the project.
Brick Faced Precast Concrete Sandwich Panel	Same as above, except an exterior brick face is attached to the precast concrete sandwich panels.
Stone Faced Precast Concrete Sandwich Panel	Same as above, except an exterior stone face is attached to the precast concrete sandwich panels.
Glass Fiber Reinforced Concrete Cladding	Glass fiber reinforced concrete (GFRC) is an alternative to pre-cast concrete for building façades. Because of its strength, this type of cladding can be produced in thinner sections to meet complex architectural specifications, and is three to five times lighter than standard concrete. GFRC has excellent weather-proofing and fire-retardant qualities, and is more water and pollution-proof than standard concrete. Glass reinforced concrete offers greater versatility due to its superior compressive strength and flexibility. It is also easy to handle and fast to erect and mount on support systems due to its light weight.
Stone Profile Cladding	Stone profile cladding is a natural stone panel system consisting of Z-shaped interlocking panels, stone corner pieces (quoins) and integrated fixing clips. All edges on both straight and corner panels are made of hand-dressed stone. The stone cladding panel system uses

MATERIALS EFFICIENCY MEASURES IN EDGE

	large (approx.) 600 x 200 mm panels which allows the use of larger pieces of stone to build a panel, giving a natural appearance. It saves both time and money compared to traditional stone masonry.
Cement Fiber Boards on Metal Studs	Cement fiber board used to clad buildings may also be referred to as “siding” or “ship lap cladding.” It has the advantage of being more stable than wood through an extreme range of weather conditions and it won’t rot, twist or warp. It is used to replace timber cladding in new build and refurbishment projects. Boarding is often self-colored so it doesn’t need painting. The board can be fixed to timber or steel studs, and is easily cut by scoring and snapping external corners and edges.
Cement Fiber Boards on Timber Studs	Same as above, except on timber studs instead of metal studs.
Timber Weatherboard on Timber Studs	Timber cladding can be used in many forms to achieve a wide variety of pattern, texture and colors ranging from the use of shingles or shakes through to prefinished panels. However, the most common form of timber cladding consists of boards laid vertically, diagonally or horizontally with either overlapping or flush faces. Timber for stud walls should be made from local forest-department-certified wood or a forest-stewardship-council-certified wood.
UPVC Weatherboard on Timber Studs	Same as above, except with UPVC weatherboard instead of timber weatherboard. UPVC (unplasticized polyvinyl chloride) is a tough, durable plastic. UPVC cladding looks like timber cladding but usually has a thinner section as UPVC can be easily molded. It can be easier to work with UPVC than timber because it is manufactured with more accurate dimensions, does not twist, warp or split and there are no knots in it.
Clay Tiles Cladding (or “Terracotta Rainscreen Cladding”) on Metal Studs	Terracotta rainscreen tiles are fixed onto a steel or aluminum substructure. The substructure is generally formed of vertical “T” support rails and adjustable brackets, or brackets fixed along the horizontal axis of the support wall. Terracotta tiles are then mounted on the substructure using self-tapping stainless-steel screws or aluminum hollow rivets, and held in place at four points with proprietary clips. Terracotta tiles are made of clay fired at high temperatures, normally achieved by the combustion of fossil fuels, and therefore have high embodied energy.
Plasterboards on Timber Studs	Plasterboard is a form of wallboard manufactured using a core of gypsum plaster bonded to layers of paper or fiberboard. It can be mounted on timber studs.
Plasterboards on Metal Studs	Same as above, except mounted on metal studs instead of timber studs.
Curtain Walling (Opaque Element)	A curtain wall is a vertical building enclosure which supports no load other than its own weight and the environmental forces which act upon it. Curtain walls are not intended to assist in maintaining the structural integrity of a building. Dead loads and live loads are thus not intended to be transferred via the curtain wall to the foundations.

MATERIALS EFFICIENCY MEASURES IN EDGE

3-D Wire Panel with "Shot-crete" Both Sides	<p>3D wire panel is a spatial structure consisting of the following elements:</p> <ul style="list-style-type: none">• Welded reinforcing mesh of high wire diameter 3mm and a mesh size 50 × 50mm• Diagonal wire (stainless or galvanized) wire of diameter 4mm• Core of expanded polystyrene of thickness 50 - 120mm• Concrete sprayed on the wire structure
Aluminum-clad Sandwich Panel	<p>Sandwich panels provide a combination of high structural rigidity and low weight and are used in a variety of applications. An aluminum-clad sandwich panel is made of three layers: a low-density core with a thin skin-layer of aluminum bonded to each side. The core may be empty or honeycombed and may contain insulation.</p>
Steel-clad Sandwich Panel	<p>Sandwich panels provide a combination of high structural rigidity and low weight and are used in a variety of applications. A steel-clad sandwich panel is made of three layers: a low-density core with a thin skin-layer of steel bonded to each side. The core may be empty or honeycombed and may contain insulation. Steel is stronger than aluminum, so there is less likelihood of the core being honeycombed for strength.</p>
Re-use of Existing Wall	<p>Re-using an existing material avoids the use, and therefore embodied energy, of new materials. The re-use of existing materials option in EDGE is highly desirable and assigned an embodied energy value of zero. The material must be verifiably more than five years old to be classified as re-used. The material does not have to have been sourced from the project site.</p>

Relationship to Other Measures

The selected external wall specification will impact the thermal insulation of the external wall element, so the energy efficiency could be adversely affected or improved by selecting different specifications.

MATERIALS EFFICIENCY MEASURES IN EDGE

Compliance Guidance

Design Stage	Post-Construction Stage
<p>At the design stage, the following must be used to demonstrate compliance:</p> <ul style="list-style-type: none"> • Drawings of the external wall sections; and • Building plans or elevations highlighting the area of major external wall types if more than one type of external wall is present; and • Manufacturer’s data sheets for the specified building materials; or • Bill of quantities with the specifications for the materials used for the walls clearly highlighted. 	<p>At the post-construction stage, the following must be used to demonstrate compliance:</p> <ul style="list-style-type: none"> • Documents from the design stage if not already submitted. Include any updates made to the documents to clearly reflect As-Built conditions; and • Date-stamped photographs of the walls taken during construction showing the claimed products on site; or • Purchase receipts showing the installed products. <p>Existing building projects</p> <ul style="list-style-type: none"> • If the documents required above are not available, other evidence of construction details, such as existing building drawings or photos taken during renovation can be submitted.

MATERIALS EFFICIENCY MEASURES IN EDGE

MEM06* – INTERIOR WALLS

Requirement Summary

This measure selection must be made, and the selected value must reflect the type of interior wall used in the project.

Intention

The intent is to reduce the embodied energy in the building by specifying interior wall types with lower embodied energy than a typical interior wall.

Approach/Methodologies

The interior walls of the building are those that are within the building and not exposed to the outdoor environment.

EDGE evaluates the embodied energy of the wall construction type by aggregating the impact of all the key materials such as brick and plaster or gypsum board used in its construction per unit area. The thickness of the wall also determines the embodied energy per unit area. The design team must select the specification that matches or most closely resembles the interior wall specified in the project and enter its thickness.

If there are multiple specifications, the predominant specification must be selected as the primary interior wall type. A second type of construction can also be indicated and marked with its percentage (%) area. The second type of construction needs to be indicated only if it represents more than 10% of the area; areas smaller than 10% are optional. If there are more than two types of construction, the smaller areas can be modeled as one of the two predominant types being modeled with which they match more closely.

Potential Technologies/Strategies

The following is a list of the specifications included in EDGE. Only the broad wall types are described here; EDGE does not include options on plaster or finishing. The user must always try to select the specification that most closely resembles that of the building design.

Common Brick Wall with Plaster Both Sides	Common bricks, also known as fired clay bricks, are popular with builders as they are easily available and inexpensive. However, because common bricks are fired at high temperatures, normally achieved by the combustion of fossil fuels, they have high embodied energy.
Cored (with Holes) Bricks with Plaster Both Sides	Cored clay blocks are made of fired clay and have a holed cross-section. The holed structure means that there is less material per square meter of finished wall.

MATERIALS EFFICIENCY MEASURES IN EDGE

<p>Honeycomb Clay Blocks with Plaster on Both Sides</p>	<p>Honeycomb clay blocks are made of fired clay and have a honeycombed cross-section. The large size of the blocks enables rapid construction, and the honeycomb structure means that there is less material per square meter of finished wall. The features listed below make honeycomb clay blocks an eco-friendlier building product:</p> <ul style="list-style-type: none"> ○ The honeycomb structure leads to improved thermal performance. ○ Blocks can be customized. ○ No mortar is needed in the vertical joints due to a tongue and grooved edge, reducing mortar use by up to 40%. ○ The blocks are strong and have a high impact resistance. ○ Honeycomb clay blocks have post-consumer value if dismantled carefully.
<p>Medium Weight Hollow Concrete Blocks</p>	<p>Hollow concrete blocks are lightweight and easier to handle than solid concrete blocks. The lightness of the blocks helps in reducing the dead load of the masonry on the structure. The voids also marginally improve the thermal insulation and sound insulation of the block. The larger size of the blocks (compared to conventional burnt clay bricks) also reduces the number of mortar joints and hence the amount of cement mortar.</p>
<p>Solid Dense Concrete Blocks</p>	<p>Solid dense concrete blocks can be used in virtually any part of a building. They provide excellent sound insulation and their high strength makes them applicable for use in structural walls. However, the use of virgin aggregates and sand can lead to land or marine degradation and resource depletion, and the lack of supplementary materials in the cement results in increased embodied energy.</p>
<p>Autoclaved Aerated Concrete Blocks</p>	<p>Aerated concrete is a versatile, lightweight building material. Compared to solid dense concrete blocks, aerated concrete blocks have a lower density and excellent insulation properties. They are durable and have good resistance to sulphate attack and damage by fire and frost. Aerated concrete blocks are excellent thermal insulators.</p> <p>Based on volume, the manufacture of aerated blocks typically uses 25% less energy than other concrete blocks. They are lighter weight which makes them easier to work with and saves energy in transportation.</p>
<p>Fly-Ash Stabilized Soil Blocks</p>	<p>Soil blocks have some inherent weaknesses that can be corrected using stabilization materials like fly ash or ground granulated blast furnace slag (GGBFS).</p> <p>Fly ash usually refers to industrial waste produced during coal combustion.</p>

MATERIALS EFFICIENCY MEASURES IN EDGE

<p>Compressed Stabilized Earth Blocks</p>	<p>Stabilized Compressed Earth Block (SCEB) technology uses local soil mixed with sand if required and a small percentage (about 5-10%) of ordinary Portland cement (OPC) as the stabilizing agent. It offers a cost-effective and environmentally-friendly alternative to conventional building materials. The blocks are fire-resistant, provide better thermal insulation and do not need to be fired, so they have lower embodied energy.</p>
<p>Ground Granulated Blast Furnace Slag (GGBS) Stabilized Soil Blocks</p>	<p>GGBS is a by-product of the iron industry. The molten slag is cooled rapidly with water and is then ground into a fine cementations powder. GGBFS can then be used as a cement replacement in the blocks.</p>
<p>Rammed Earth Blocks/Walls</p>	<p>Rammed earth walls are more commonly used in arid areas. They are constructed by the compacting (ramming) of moistened subsoil into place between temporary formwork panels. When dried, the result is a dense, hard monolithic wall. As an alternative, rammed earth bricks are also available. The high moisture mass of rammed earth helps regulate humidity.</p>
<p>Precast Concrete Panels</p>	<p>Precast concrete is a construction product made by casting concrete in a reusable molding or “form” which is then cured in a controlled environment, transported to the construction site, and lifted into place.</p> <p>Precast cladding or curtain walls are the most common use of precast concrete for building envelopes. These types of precast concrete panels do not transfer vertical loads but simply enclose the space. They are only designed to resist wind, seismic forces generated by their own weight, and forces requiring transferring the weight of the panel to the support. Common cladding units include wall panels, window wall units, spandrels, mullions and column covers. These units can usually be removed individually if necessary.</p> <p>In some cases, precast panels are used as formwork for cast-in-place concrete. The precast panels act as a form, providing the visible aesthetics of the system, while the cast-in-place portion provides the structural component.</p>
<p>Straw Bale Blocks</p>	<p>Straw bale blocks are a rapidly renewable building material made from the dry stalk left in the earth after harvest, which is traditionally considered a waste product that is burned or baled and sold for animal use. It is a natural, non-toxic building material with low environmental impact and excellent insulation properties. Since it is very easy to work it is a good choice for amateur or unskilled self-builders.</p> <p>Straw bale houses are finished and coated with cement stucco or earth-based plaster, sealing the straw from the elements and giving long-lasting protection with little maintenance. In contrast to the timber used for wood framing, straw can be grown in less than a year in a completely sustainable production system. The conversion of straw into a sustainable renewable resource to be used as a dominant building material could be especially beneficial in areas where the climate is severe and timber is scarce, but straw is plentiful.</p>

MATERIALS EFFICIENCY MEASURES IN EDGE

Ferrocement Wall Panels	<p>Ferrocement is a very simple construction of 2 to 5 layers of chicken wire over a frame made from reinforcing bar, with cement forced into the gaps and in a layer over the chicken wire reinforcing. The use of chicken wire makes ferrocement a very flexible building material that is strongest when curved.</p>
In-Situ Reinforced Wall	<p>More commonly used for floor slabs and roofs, in-situ reinforced concrete is also used to construct walls. It has a high embodied energy due to the inclusion of Portland cement and uses sand, aggregate, water and reinforcing steel.</p>
Cellular Light Weight Concrete Blocks	<p>These blocks, which are environmentally friendly, are also called CLC blocks. The energy consumed in production is only a fraction compared to the production of clay bricks. They are made from slurry of cement, fly Ash*, and water, which is further mixed with the addition of pre-formed stable foam in an ordinary concrete mixer under ambient conditions.</p> <p>The addition of foam to the concrete mixture creates millions of tiny voids or cells in the material, hence the name Cellular Concrete.</p> <p>*Fly ash is a waste material from thermal power plants.</p>
Stone Blocks	<p>Limestone makes up about 10% of the total volume of all sedimentary rocks. Although limestone is found widely, developers and designers should opt for local extracted stone to reduce transport implications.</p> <p>Limestone is readily available and relatively easy to cut into blocks in a quarry. It is also long-lasting and stands up well to exposure, as it is hard, durable and commonly occurs in easily accessible surface exposures. Because of its mass, it has a high thermal inertia.</p> <p>However, limestone is a very heavy material, making it impractical for tall buildings, and relatively expensive as a building material.</p>
Stone Blocks – Hand Cut	<p>Same as above, except hand-cut and not polished. The embodied energy is in the extraction process and heavy transportation loads.</p>
Stone Blocks – Machine Cut Unpolished	<p>Quarried stone, machine-cut and not polished. The quarried stone is typically of medium hardness between limestone and granite. The embodied energy is in the extraction process and cutting with a mechanized saw.</p>

MATERIALS EFFICIENCY MEASURES IN EDGE

<p>FaLG Block</p>	<p>The Fly Ash-Lime-Gypsum blocks technology primarily uses industrial wastes such as fly ash (from thermal power plants), lime gypsum (from fertilizer industries) and sand (optional) to produce alternative walling materials. It reduces the environmental impacts associated with disposal of these industrial wastes, and avoids the environmental impacts associated with clay brick production, such as denudation of fertile topsoil. As the process for FAL-G blocks does not require sintering, the amount of energy (fossil fuels) for production is reduced.</p> <p>The manufacturing process consists of three main stages:</p> <ul style="list-style-type: none"> - Mixing the materials: Fly ash is mixed with lime and gypsum. Chemical accelerator may or may not be added to it. - Pressing the mix in a machine: the mix is molded under pressure, also air/sun drying may be undertaken; and - Curing the blocks for a stipulated period: the green block is water cured. <p>In the presence of moisture, fly ash reacts with lime at ordinary temperature and forms a compound possessing cementations properties. After reactions between lime and fly ash, calcium silicate hydrates are produced which are responsible for the high strength of the compound.</p> <p>Generally, FAL-G blocks are gray in color, solid and have plain rectangular faces with parallel sides and sharp, straight and right-angled edges. It is also used for development of infrastructure, construction of pavements, dams, tanks and under water works.</p>
<p>Common Brick Wall No Finish</p>	<p>Same as common brick wall, except without any plaster finish.</p>
<p>Cored (with Holes) Bricks No Finish</p>	<p>Same as cored brick wall, except without any plaster finish.</p>
<p>Precast Concrete Sandwich Panel</p>	<p>Precast concrete sandwich panels comprise an outer leaf of precast concrete, an insulating layer "sandwiched" in between, and an inner leaf of plain gray concrete with a power floated finish. The panels may be attached to a steel frame as a cladding panel, or they can form part of a precast structural frame where the inner leaf is load bearing and the external leaf is connected to and supported off the internal leaf using ties. The ties used in the precast structural frames are made of metal, plastic or epoxy and have low thermal conductivity to eliminate cold bridging. The thickness of the insulation depends on the required U-value. The shape, thickness and size of the concrete can also be varied to meet the requirements of the project.</p>

MATERIALS EFFICIENCY MEASURES IN EDGE

Cement Fiber Boards on Metal Studs	Cement fiber board used to clad buildings may also be referred to as “siding” or “ship lap cladding.” It has the advantage of being more stable than wood through an extreme range of weather conditions and it won’t rot, twist or warp. It is used to replace timber cladding in new build and refurbishment projects. Boarding is often self-colored so it doesn’t need painting. The board can be fixed to timber or steel studs, and is easily cut by scoring and snapping external corners and edges.
Cement Fiber Boards on Timber Studs	Same as above, except on timber studs instead of metal studs.
Plasterboards on Timber Studs	Plasterboard is a form of wallboard manufactured using a core of gypsum plaster bonded to layers of paper or fiberboard. It can be mounted on timber studs.
Plasterboards on Timber Studs with Insulation	Same as above, except with insulation between the timber studs.
Plasterboards on Metal Studs	Same as above, except mounted on metal studs instead of timber studs.
Plasterboards on Metal Studs with Insulation	Same as above, except with insulation between the metal studs.
3-D Wire panel with “Shot-crete” Both Sides	<p>3D wire panel is a spatial structure consisting of the following elements:</p> <ul style="list-style-type: none"> • Welded reinforcing mesh of high wire diameter 3mm and a mesh size 50 × 50mm • Diagonal wire (stainless or galvanized) wire of diameter 4mm • Core of expanded polystyrene of thickness 50 - 120mm (embodied energy of insulation <u>is not</u> included in this material) • Concrete sprayed on the wire structure
3-D Wire Panel with “Shot-crete” Both Sides with Insulation	Same as above, except that the embodied energy of insulation <u>is</u> included in this material.
Re-use of Existing Wall	Re-using an existing material avoids the use, and therefore embodied energy, of new materials. The re-use of the existing materials option in EDGE is highly desirable and assigned an embodied energy value of zero. The material must be verifiably more than five years old to be classified as re-used. The material does not have to have been sourced from the project site.

MATERIALS EFFICIENCY MEASURES IN EDGE

Relationship to Other Measures

The specification of internal walls does not affect other EDGE measures but can impact acoustic performance.

Compliance Guidance

Design Stage	Post-Construction Stage
<p>At the design stage, the following must be used to demonstrate compliance:</p> <ul style="list-style-type: none">• Drawings of the internal wall sections; and• Building plans or elevations highlighting the area of major internal wall types if more than one type of internal wall is present; and• Manufacturer’s data sheets for the specified building materials; or• Bill of quantities with the specifications for the materials used for the walls clearly highlighted.	<p>At the post-construction stage, the following must be used to demonstrate compliance:</p> <ul style="list-style-type: none">• Documents from the design stage if not already submitted. Include any updates made to the documents to clearly reflect As-Built conditions; and• Date-stamped photographs of the walls taken during construction showing the claimed products on site; or• Purchase receipts showing the installed products. <p>Existing building projects</p> <ul style="list-style-type: none">• If the documents required above are not available, other evidence of construction details, such as existing building drawings or photos taken during renovation can be submitted.

MATERIALS EFFICIENCY MEASURES IN EDGE

MEM07* – WINDOW FRAMES

Requirement Summary

This measure selection must be made, and the selected value must reflect the type of window frames used in the project.

Intention

The intent is to reduce the embodied energy in the building by specifying window frames with lower embodied energy than the typical window frames.

Approach/Methodologies

Window frames in EDGE include the frames for all the exterior glazing in a building, including any exterior glass doors. EDGE provides several options for the materials of window frames. The design team must select the specification that matches or most closely resembles the window frames specified.

If there are multiple specifications, the predominant specification must be selected as the primary window frame type. A second type of frame can also be indicated and marked with its percentage (%) area. The second type of frame needs to be indicated only if it represents more than 10% of the area; areas smaller than 10% are optional. If there are more than two types of frame, the smaller areas can be modeled as one of the two predominant types being modeled with which they match more closely.

Potential Technologies/Strategies

The following is a list of the specifications included in EDGE. The user must always try to select the specification that most closely resembles that of the building design.

Aluminum	The two metals typically used for window frames are aluminum or steel. Aluminum is lighter weight and does not rust like a ferrous metal such as steel, but the embodied energy is much higher. The advantage of using metal window frames is that they are strong, light and require less maintenance than other materials used for window frames. However as metal conducts heat very well, the thermal performance of metal windows is not as good as other materials. To reduce heat flow and U-Value, metal frames can include a thermal break between the inside and outside of the frame.
Steel	Like aluminum windows above, except steel windows are heavier than aluminum and require some maintenance to protect from rust (unless stainless steel is used). Steel has somewhat better thermal performance than aluminum.

MATERIALS EFFICIENCY MEASURES IN EDGE

Timber	Timber window frames insulate relatively well, but they also expand and contract in response to weather conditions. Timber frames can be made from either softwood or hardwood. Softwood frames are much cheaper, but are likely to require more regular maintenance. The maintenance required can be reduced by using aluminum or vinyl cladding.
UPVC	uPVC window frames are made of extruded polyvinyl chloride (PVC) with ultraviolet light (UV) stabilizers to keep sunlight from breaking down the material. uPVC window frames are low maintenance as they do not require painting. If the cavities of uPVC frames are filled with insulation, they have very good thermal performance.
Aluminum Clad Timber	Aluminum cladding is fixed to wooden framing members with a space for ventilation purposes. Timber and aluminum have high embodied energy. The extruded aluminum sections are designed for strength and rigidity, to prevent deformation at the fastening points. Often used in commercial applications, these windows are also suitable for residential applications where low maintenance is important, such as social housing and high-rise developments.
Re-use of Existing Window Frames	Re-using an existing material avoids the use, and therefore embodied energy, of new materials. The re-use of existing materials option in EDGE is highly desirable and assigned an embodied energy value of zero. The material must be verifiably more than five years old to be classified as re-used. The material does not have to have been sourced from the project site.

Relationship to Other Measures

The choice of window frame material will have an impact on thermal performance. EDGE does not directly take account of this as it is already reflected in the manufacturer's calculation of the window U-value.

MATERIALS EFFICIENCY MEASURES IN EDGE

Compliance Guidance

Design Stage	Post-Construction Stage
<p>At the design stage, the following must be used to demonstrate compliance:</p> <ul style="list-style-type: none"> • Building elevations marking the window frame(s) specifications; or • A window schedule for the building showing the major window frame types if more than one type of window frame is present; and • Manufacturer’s data sheets for the specified window frames; or • Bill of quantities with the specifications for the windows/window frames highlighted. • This measure includes exterior glass doors. 	<p>At the post-construction stage, the following must be used to demonstrate compliance:</p> <ul style="list-style-type: none"> • Documents from the design stage if not already submitted. Include any updates made to the documents to clearly reflect As-Built conditions; and • Manufacturer’s data sheets showing the make and model, material and U-value of the installed window frames; and • Date-stamped photographs of the window frames during or after installation showing the make and model; or • Purchase receipts showing the make and model of the installed window frames. • This measure includes exterior glass doors. <p>Existing building projects</p> <ul style="list-style-type: none"> • If the documents required above are not available, other evidence of construction details, such as existing building drawings or photographs can be submitted.

MATERIALS EFFICIENCY MEASURES IN EDGE

MEM08* – WINDOW GLAZING

Requirement Summary

This measure selection must be made, and the selected value must reflect the type of window glazing used in the project.

Intention

The intent is to reduce the embodied energy in the building by specifying window glazing with relatively lower embodied energy.

Approach/Methodologies

Window glazing in EDGE includes all the exterior glass in a building, including any glass for exterior doors. Embodied energy is calculated based on the area of the windows specified in the window-to-wall ratio in the Energy tab multiplied by the embodied energy of the window glass per unit area.

EDGE provides three options for the window glazing — single, double, or triple pane. The design team must select the specification that matches the window glazing specified in the building.

If there are multiple specifications, the predominant specification must be selected as the primary glass type. A second type can also be indicated and marked with its percentage (%) area. The second type needs to be indicated only if it represents more than 10% of the area; areas smaller than 10% are optional. If there are more than two types of glass, the smaller areas can be modeled as one of the two predominant types being modeled with which they match more closely.

Potential Technologies/Strategies

The following is a list of the glass types included in EDGE.

Single Glazing	A single pane (sheet) of glass in the windows.
Double Glazing	Two panes of glass
Triple	Timber window frames insulate relatively well, but they also expand and contract in response to weather conditions. Timber frames can be made from either softwood or hardwood. Softwood frames are much cheaper, but are likely to require more regular maintenance. The maintenance required can be reduced by using aluminum or vinyl cladding.

MATERIALS EFFICIENCY MEASURES IN EDGE

Relationship to Other Measures

Double and triple glazing is more energy efficient and will reduce energy use for cooling and heating. However, increasing the number of panes will increase the embodied energy of the windows. A lower WWR can be considered as a potential strategy to balance this increase.

Compliance Guidance

Design Stage	Post-Construction Stage
<p>At the design stage, the following must be used to demonstrate compliance:</p> <ul style="list-style-type: none">• Building elevations marking the window glass specifications; or• A window schedule for the building showing the major window glass types if more than one type of glass is present; and• Manufacturer’s data sheets for the specified glazing; or• Bill of quantities with the specifications for the window glass highlighted.• This measure includes exterior glass doors.	<p>At the post-construction stage, the following must be used to demonstrate compliance:</p> <ul style="list-style-type: none">• Documents from the design stage if not already submitted. Include any updates made to the documents to clearly reflect As-Built conditions; and• Manufacturer’s data sheets showing the make and model, U-value and SHGC of the installed glass; and• Date-stamped photographs of the glazing during or after installation showing the make and model; or• Purchase receipts showing the make and model of the installed windows/glass.• This measure includes exterior glass doors. <p>Existing building projects</p> <ul style="list-style-type: none">• If the documents required above are not available, other evidence of construction details, such as existing building drawings or photographs can be submitted.

MEM09* – ROOF INSULATION

Requirement Summary

This measure selection must be made, and the selected value must reflect the type of roof insulation used in the project.

Intention

The intent is to reduce the embodied energy in the building by specifying roof insulation with relatively lower embodied energy.

Approach/Methodologies

The design team must select the specification that most closely resembles the insulation specified.

If there are multiple specifications, the predominant specification must be selected as the primary insulation type. A second type can also be indicated and marked with its percentage (%) area. The second type needs to be indicated only if it represents more than 10% of the area; areas smaller than 10% are optional. If there are more than two types of insulation, the smaller areas can be modeled as one of the two predominant types being modeled with which they match more closely.

If the base case assumes that no insulation is specified, the embodied energy calculation will not take account of the insulation selected unless the Insulation of Roof Surface and/or Insulation of External Walls measures are selected in the energy efficiencies section.

Potential Technologies/Strategies

The following is a list of the insulation types included in EDGE. The user must select the insulation that most closely resembles the insulation used in the building.

Polystyrene	<p>Polystyrene has the highest embodied energy per square meter of any other insulation type. There are two types of polystyrene insulation:</p> <p>Expanded Polystyrene (EPS) insulation is made from small beads of polystyrene that when heated cause them to expand; they are then mixed with a blowing agent (pentane). Expanded polystyrene is available in board form or as beads. Boards are produced by placing the beads in molds and heating them to fuse the beads together. Typical applications of EPS boards are for insulation of walls, roofs and floors. Polystyrene beads are frequently used as cavity fill in masonry walls.</p> <p>Extruded Polystyrene (XPS) is made by mixing polystyrene with a blowing agent under pressure and forcing it through a die. As it emerges from the die it expands into foam; it can then be shaped and trimmed. XPS is slightly stronger than EPS, and although it is used in many of the same applications as EPS, it is particularly suitable for use below ground or where extra loading and/or impacts might be anticipated.</p>
--------------------	--

MATERIALS EFFICIENCY MEASURES IN EDGE

Mineral Wool	Rock-based mineral wool is made by melting rock and recycled steel slag and spinning it into fibers. The insulation is available in different densities depending on the required functionality. Higher densities provide better sound insulation but poorer thermal insulation. Applications include masonry cavity walls, timber frame walls and insulation for roof rafters, lofts and suspended floors. Mineral wool has low resistance for moisture.
Glass Wool	Glass wool insulation is manufactured in a similar way to rock wool, though the raw materials are different as well as the melting process. Glass wool is made from silica sand, recycled glass, limestone and soda ash. Higher densities provide better sound insulation but poorer thermal insulation. Applications include masonry cavity walls, timber frame walls, and insulation for roof rafters, lofts and suspended floors.
Polyurethane	Polyurethane (PUR), a closed-cell plastic, is formed by reacting two monomers in the presence of a blowing agent catalyst (polymerization). Polyisocyanurate foam (PIR) is an improvement on polyurethane (there is a slight difference in the constituents and the reaction is conducted at higher temperatures). PIR is more fire-resistant and has a slightly higher R Value. Applications include wall, floor and roof insulation. Polyurethane is also popular in laminate form in SIPS and as an insulation backing to rigid boarding such as plasterboard.
Cellulose	Four major types of loose-fill cellulose products have been developed for differing uses in a building under a variety of brand names. These are characterized as: 1. Dry cellulose 2. Spray applied cellulose 3. Stabilized cellulose 4. Low dust cellulose.
Cork	Cork has low embodied energy and is environmentally friendly. It can be harvested from the same tree for about two hundred years. Harvesting is done with minimal impact on the environment and no trees are cut down to manufacture cork products.
Woodwool	Woodwool boards have been used in buildings for decades and are a popular substrate for lime plaster. Strands of wood, bound together with a small proportion of Portland cement, provide a good background for lime plasters, eliminate thermal bridges in pillars, beams, inter-story facings and radiator niches and provide insulation of flat and sloping roofs; provide acoustic insulation of walls and insulation from floor noise; as well as fire resistant coverings.
Air Gap <100mm Wide	In principle, the use of cavities is like the use of an insulating material. Air is a poor conductor of heat, therefore still air trapped in an air space between two layers of a wall or roof acts as a barrier to heat transfer.
Air Gap >100mm Wide	Gaps larger than 100mm encourage convection and are not effective insulators.
No Insulation	This option must be selected if no insulation is specified for the roof or walls.

Relationship to Other Measures

If insulation is selected in the Materials tab when no insulation has been indicated in the Energy measures, it will result in some reduction in energy use over the base case.

MATERIALS EFFICIENCY MEASURES IN EDGE

Compliance Guidance

Design Stage	Post-Construction Stage
<p>At the design stage, the following must be used to demonstrate compliance:</p> <ul style="list-style-type: none">• Drawings marking the type(s) of insulation specified; and• Building plans marking the area of major insulation types if more than one type of insulation is present; and• Manufacturer’s data sheets for the specified insulation; or• Bill of quantities with the specifications for the insulation materials highlighted.	<p>At the post-construction stage, the following must be used to demonstrate compliance:</p> <ul style="list-style-type: none">• Documents from the design stage if not already submitted. Include any updates made to the documents to clearly reflect As-Built conditions; and• Manufacturer’s data sheets showing the brand and product name and insulating properties of the installed insulation; and• Date-stamped photographs of the insulation during construction showing the product; or• Purchase receipts showing the brand and product installed. <p>Existing building projects</p> <ul style="list-style-type: none">• If the documents required above are not available, other evidence of construction details, such as existing building drawings or photographs can be submitted.

MATERIALS EFFICIENCY MEASURES IN EDGE

MEM10* – WALL INSULATION

Requirement Summary

This measure selection must be made, and the selected value must reflect the type of wall insulation used in the project.

Intention

The intent is to reduce the embodied energy in the building by specifying wall insulation with relatively lower embodied energy.

Approach/Methodologies

The design team must select the specification that most closely resembles the insulation specified.

If there are multiple specifications, the predominant specification must be selected as the primary insulation type. A second type can also be indicated and marked with its percentage (%) area. The second type needs to be indicated only if it represents more than 10% of the area; areas smaller than 10% are optional. If there are more than two types of insulation, the smaller areas can be modeled as one of the two predominant types being modeled with which they match more closely.

If the base case assumes that no insulation is specified, the embodied energy calculation will not take account of the insulation selected unless the Insulation of Roof Surface and/or Insulation of External Walls measures are selected in the energy efficiencies section.

Potential Technologies/Strategies

The following is a list of the insulation types included in EDGE. The user must select the insulation that most closely resembles the insulation used in the building.

Polystyrene	<p>Polystyrene has the highest embodied energy per square meter of any other insulation type. There are two types of polystyrene insulation:</p> <p>Expanded Polystyrene (EPS) insulation is made from small beads of polystyrene that when heated cause them to expand; they are then mixed with a blowing agent (pentane). Expanded polystyrene is available in board form or as beads. Boards are produced by placing the beads in molds and heating them to fuse the beads together. Typical applications of EPS boards are for insulation of walls, roofs and floors. Polystyrene beads are frequently used as cavity fill in masonry walls.</p> <p>Extruded Polystyrene (XPS) is made by mixing polystyrene with a blowing agent under pressure and forcing it through a die. As it emerges from the die it expands into foam; it can then be shaped and trimmed. XPS is slightly stronger than EPS, and although it is used in many of the same applications as EPS, it is particularly suitable for use below ground or where extra loading and/or impacts might be anticipated.</p>
--------------------	--

MATERIALS EFFICIENCY MEASURES IN EDGE

Mineral Wool	Rock-based mineral wool is made by melting rock and recycled steel slag and spinning it into fibers. The insulation is available in different densities depending on the required functionality. Higher densities provide better sound insulation but poorer thermal insulation. Applications include masonry cavity walls, timber frame walls and insulation for roof rafters, lofts and suspended floors. Mineral wool has low resistance for moisture.
Glass Wool	Glass wool insulation is manufactured in a similar way to rock wool, though the raw materials are different as well as the melting process. Glass wool is made from silica sand, recycled glass, limestone and soda ash. Higher densities provide better sound insulation but poorer thermal insulation. Applications include masonry cavity walls, timber frame walls, and insulation for roof rafters, lofts and suspended floors.
Polyurethane	Polyurethane (PUR), a closed-cell plastic, is formed by reacting two monomers in the presence of a blowing agent catalyst (polymerization). Polyisocyanurate foam (PIR) is an improvement on polyurethane (there is a slight difference in the constituents and the reaction is conducted at higher temperatures). PIR is more fire-resistant and has a slightly higher R Value. Applications include wall, floor and roof insulation. Polyurethane is also popular in laminate form in SIPS and as an insulation backing to rigid boarding such as plasterboard.
Cellulose	Four major types of loose-fill cellulose products have been developed for differing uses in a building under a variety of brand names. These are characterized as: 1. Dry cellulose 2. Spray applied cellulose 3. Stabilized cellulose 4. Low dust cellulose.
Cork	Cork has low embodied energy and is environmentally friendly. It can be harvested from the same tree for about two hundred years. Harvesting is done with minimal impact on the environment and no trees are cut down to manufacture cork products.
Woodwool	Woodwool boards have been used in buildings for decades and are a popular substrate for lime plaster. Strands of wood, bound together with a small proportion of Portland cement, provide a good background for lime plasters, eliminate thermal bridges in pillars, beams, inter-story facings and radiator niches and provide insulation of flat and sloping roofs; provide acoustic insulation of walls and insulation from floor noise; as well as fire resistant coverings.
Air Gap <100mm Wide	In principle, the use of cavities is like the use of an insulating material. Air is a poor conductor of heat, therefore still air trapped in an air space between two layers of a wall or roof acts as a barrier to heat transfer.
Air Gap >100mm Wide	Gaps larger than 100mm encourage convection and are not effective insulators.
No Insulation	This option must be selected if no insulation is specified for the roof or walls.

Relationship to Other Measures

If insulation is selected in the Materials tab when no insulation has been indicated in the Energy measures, it will result in some reduction in energy use over the base case.

MATERIALS EFFICIENCY MEASURES IN EDGE

Compliance Guidance

Design Stage	Post-Construction Stage
<p>At the design stage, the following must be used to demonstrate compliance:</p> <ul style="list-style-type: none">• Drawings marking the type(s) of insulation specified; and• Building plans marking the area of major insulation types if more than one type of insulation is present; and• Manufacturer’s data sheets for the specified insulation; or• Bill of quantities with the specifications for the insulation materials highlighted.	<p>At the post-construction stage, the following must be used to demonstrate compliance:</p> <ul style="list-style-type: none">• Documents from the design stage if not already submitted. Include any updates made to the documents to clearly reflect As-Built conditions; and• Manufacturer’s data sheets showing the brand and product name and insulating properties of the installed insulation; and• Date-stamped photographs of the insulation during construction showing the product; or• Purchase receipts showing the brand and product installed. <p>Existing building projects</p> <ul style="list-style-type: none">• If the documents required above are not available, other evidence of construction details, such as existing building drawings or photographs can be submitted.

MEM11* – FLOOR INSULATION

Requirement Summary

This measure selection must be made, and the selected value must reflect the type of floor insulation used in the project.

Intention

The intent is to reduce the embodied energy in the building by specifying floor insulation with relatively lower embodied energy.

Approach/Methodologies

The design team must select the specification that most closely resembles the insulation specified.

If there are multiple specifications, the predominant specification must be selected as the primary insulation type. A second type can also be indicated and marked with its percentage (%) area. The second type needs to be indicated only if it represents more than 10% of the area; areas smaller than 10% are optional. If there are more than two types of insulation, the smaller areas can be modeled as one of the two predominant types being modeled with which they match more closely.

If the base case assumes that no insulation is specified, the embodied energy calculation will not take account of the insulation selected unless the Insulation of Roof Surface and/or Insulation of External Walls measures are selected in the energy efficiencies section.

Potential Technologies/Strategies

The following is a list of the insulation types included in EDGE. The user must select the insulation that most closely resembles the insulation used in the building.

Polystyrene	<p>Polystyrene has the highest embodied energy per square meter of any other insulation type. There are two types of polystyrene insulation:</p> <p>Expanded Polystyrene (EPS) insulation is made from small beads of polystyrene that when heated cause them to expand; they are then mixed with a blowing agent (pentane). Expanded polystyrene is available in board form or as beads. Boards are produced by placing the beads in molds and heating them to fuse the beads together. Typical applications of EPS boards are for insulation of walls, roofs and floors. Polystyrene beads are frequently used as cavity fill in masonry walls.</p> <p>Extruded Polystyrene (XPS) is made by mixing polystyrene with a blowing agent under pressure and forcing it through a die. As it emerges from the die it expands into foam; it can then be shaped and trimmed. XPS is slightly stronger than EPS, and although it is used in many of the same applications as EPS, it is particularly suitable for use below ground or where extra loading and/or impacts might be anticipated.</p>
--------------------	--

MATERIALS EFFICIENCY MEASURES IN EDGE

Mineral Wool	Rock-based mineral wool is made by melting rock and recycled steel slag and spinning it into fibers. The insulation is available in different densities depending on the required functionality. Higher densities provide better sound insulation but poorer thermal insulation. Applications include masonry cavity walls, timber frame walls and insulation for roof rafters, lofts and suspended floors. Mineral wool has low resistance for moisture.
Glass Wool	Glass wool insulation is manufactured in a similar way to rock wool, though the raw materials are different as well as the melting process. Glass wool is made from silica sand, recycled glass, limestone and soda ash. Higher densities provide better sound insulation but poorer thermal insulation. Applications include masonry cavity walls, timber frame walls, and insulation for roof rafters, lofts and suspended floors.
Polyurethane	Polyurethane (PUR), a closed-cell plastic, is formed by reacting two monomers in the presence of a blowing agent catalyst (polymerization). Polyisocyanurate foam (PIR) is an improvement on polyurethane (there is a slight difference in the constituents and the reaction is conducted at higher temperatures). PIR is more fire-resistant and has a slightly higher R Value. Applications include wall, floor and roof insulation. Polyurethane is also popular in laminate form in SIPS and as an insulation backing to rigid boarding such as plasterboard.
Cellulose	Four major types of loose-fill cellulose products have been developed for differing uses in a building under a variety of brand names. These are characterized as: 1. Dry cellulose 2. Spray applied cellulose 3. Stabilized cellulose 4. Low dust cellulose.
Cork	Cork has low embodied energy and is environmentally friendly. It can be harvested from the same tree for about two hundred years. Harvesting is done with minimal impact on the environment and no trees are cut down to manufacture cork products.
Woodwool	Woodwool boards have been used in buildings for decades and are a popular substrate for lime plaster. Strands of wood, bound together with a small proportion of Portland cement, provide a good background for lime plasters, eliminate thermal bridges in pillars, beams, inter-story facings and radiator niches and provide insulation of flat and sloping roofs; provide acoustic insulation of walls and insulation from floor noise; as well as fire resistant coverings.
Air Gap <100mm Wide	In principle, the use of cavities is like the use of an insulating material. Air is a poor conductor of heat, therefore still air trapped in an air space between two layers of a wall or roof acts as a barrier to heat transfer.
Air Gap >100mm Wide	Gaps larger than 100mm encourage convection and are not effective insulators.
No Insulation	This option must be selected if no insulation is specified for the roof or walls.

Relationship to Other Measures

If insulation is selected in the Materials tab when no insulation has been indicated in the Energy measures, it will result in some reduction in energy use over the base case.

MATERIALS EFFICIENCY MEASURES IN EDGE

Compliance Guidance

Design Stage	Post-Construction Stage
<p>At the design stage, the following must be used to demonstrate compliance:</p> <ul style="list-style-type: none">• Drawings marking the type(s) of insulation specified; and• Building plans marking the area of major insulation types if more than one type of insulation is present; and• Manufacturer’s data sheets for the specified insulation; or• Bill of quantities with the specifications for the insulation materials highlighted.	<p>At the post-construction stage, the following must be used to demonstrate compliance:</p> <ul style="list-style-type: none">• Documents from the design stage if not already submitted. Include any updates made to the documents to clearly reflect As-Built conditions; and• Manufacturer’s data sheets showing the brand and product name and insulating properties of the installed insulation; and• Date-stamped photographs of the insulation during construction showing the product; or• Purchase receipts showing the brand and product installed. <p>Existing building projects</p> <ul style="list-style-type: none">• If the documents required above are not available, other evidence of construction details, such as existing building drawings or photographs can be submitted.

REFERENCES

REFERENCES

Energy

American Society of Heating, Refrigerating and Air-Conditioning Engineers. *ASHRAE Standard for Buildings Except Low-Rise Residential Buildings, I-P Edition*. Atlanta, US: ASHRAE, 2016

American Society of Heating, Refrigerating and Air-Conditioning Engineers. *ASHRAE 90.1 Standard for Buildings, I-P Edition*. Atlanta, US: ASHRAE, 2010

Anderson, B. *Conventions for U-value calculations*. Watford, UK: British Research Establishment (BRE), 2006.
[http://www.bre.co.uk/filelibrary/pdf/rpts/BR_443_\(2006_Edition\).pdf](http://www.bre.co.uk/filelibrary/pdf/rpts/BR_443_(2006_Edition).pdf)

BC Hydro. *Commercial kitchens can save money with smart exhaust hoods*. Jan 13, 2014. Retrieved 2014, from
<http://www.bchydro.com/news/conservation/2014/commercial-kitchen-exhaust-hoods.html>

Berdahl, P. Berkeley Laboratory - Environmental Energy Technologies Division. *Cool Roofing Materials Database*. US: 2000.

Bureau of Indian Standards: *National Building Code India*. New Delhi, 2007

Callison Global. *Matrix by Callison website*: <http://matrix.callison.com/>

Carbon Trust. *Heat recovery*. Retrieved 2014, from
https://www.carbontrust.com/media/31715/ctg057_heat_recovery.pdf

Carbon Trust. *Refrigeration systems: Guide to key energy saving opportunities*. Retrieved 2015, from
https://www.carbontrust.com/media/13055/ctg046_refrigeration_systems.pdf

Carter Retail Equipment website. *Refrigerated Display Cabinets & Coldroom Solutions*. Retrieved 2014, from
<http://www.cre-ltd.co.uk/>

Chartered Institution of Building Services Engineers. *CIBSE Guide A: Environmental Design*. London: 7th Edition, 2007

Chartered Institution of Building Services Engineers. *CIBSE - Concise Handbook*. London, June 2008

Clayton innovative Steam solutions. *Heat Recovery Steam Generator*. Retrieved 2014, from
http://www.claytonindustries.com/clayton_p5_heat_recovery.html

CIBSE Journal. *Determining U-values for real building elements*. UK: CIBSE, 2011.
<http://www.cibsejournal.com/cpd/2011-06/>

City of Wilson, North Carolina. *Turn Waste Heat into Energy with Absorption Chillers*. Retrieved 2014, from
<http://members.questline.com/Article.aspx?articleID=7942&accountID=1874&nl=11427>

Cooling technology Inc. *Water cooled chillers & Air cooled chillers*. Retrieved 2014, from
http://www.coolingtechnology.com/about_process_cooling/water-cooled-chiller/default.html

REFERENCES

Dubai Municipality. *Green Building Regulations and Specifications: Practice Guide*.

Energy Saving Trust. *Replacing my boiler*. Retrieved 2014, from <http://www.energysavingtrust.org.uk/Heating-and-hot-water/Replacing-your-boiler>

Energy Saving Trust - Energy Efficiency Best Practice in Housing. *Domestic Condensing Boilers – 'The Benefits and the Myths'*. UK, November 2003.

Energy Savings Trust. *Insulation Materials Chart: Thermal properties and environmental ratings*. London: August 2010. <http://www.energysavingtrust.org.uk/Publications2/Housing-professionals/Insulation-and-ventilation/Insulation-materials-chart-thermal-properties-and-environmental-ratings>

Ethical Consumer. *Gas boilers*. Retrieved 2014, from <http://www.ethicalconsumer.org/buyersguides/energy/gasboilers.aspx>

Energy Star website. *Commercial Refrigerators & Freezers*. Retrieved 2014, from <http://www.energystar.gov/products/certified-products/detail/commercial-refrigerators-freezers>

Erwin Schawtz. DDI heat exchangers. Energy management magazine: *How to tap the energy savings in greywater*. Retrieved 2014, from <http://ddi-heatexchangers.com/wp-content/uploads/2012/09/ENERGY-RECOVERY-from-wasted-GreyWater-Feb-2013.pdf>

Glow.worn - Vaillant Group. *How does your boiler work*. Retrieved 2014, from <http://www.glow-worm.co.uk/boilers-3/your-boiler-guide/how-does-your-boiler-work/>

International Organization for Standardization (ISO). *ISO 13790:2008 Energy performance of buildings - Calculation of energy use for space heating and cooling*. 2008

Hanselaer, P. Lootens, C. Ryckaert, W.R. Deconinck, G. Rombauts, P. Power density targets for efficient lighting of interior task areas. *Laboratorium voor Lichttechnologie*, April 2007.

Heat is Power Association. *Recovery of Waste Heat from the Generator for Space Heating*. Retrieved 2014, from <http://www.heatispower.org>

Joliet Technologies. *Variable Speed Drive Systems and Controls*. Retrieved 2014, from www.joliettech.com

Norwegian University of Science and Technology. Hustad Kleven, M. *Analysis of Grey-water Heat Recovery System in Residential Buildings*. Retrieved 2014, from <http://www.diva-portal.org/smash/get/diva2:566950/FULLTEXT01.pdf>

Oak Ridge National Laboratory. Walker, D. (Foster Miller, Inc), Faramarzi, R T. (Southern California Edison RTTC) and Baxter, V D. (Oak Ridge National Lab). *Investigation of Energy-Efficient Supermarket Display Cases*. Oak Ridge, Tennessee December 2004. Retrieved 2014, from <http://web.ornl.gov/~webworks/cppr/y2001/rpt/122084.pdf>

Phipps, Clarence A. *Variable Speed Drive Fundamentals*. The Fairmont Press Inc. 1997. ISBN0-88173-258-3

Pilkington Group Limited, European Technical Centre. *Global Glass Handbook 2012: Architectural Products*. Ormskirk, Lancashire, UK: (NSG Group), 2012.

REFERENCES

Potterton. *Types of boilers*. Retrieved 2014, from <http://www.potterton.co.uk/types-of-boilers/>

Recair. *Sensible & latent heat*. Retrieved 2014, from http://www.recair.com/us/recair_enthalpy-how-it-works.php

Schneider Electric. *HVAC control - Regulate kitchen exhaust hood speed according to temperature*. Retrieved 2014, from http://www2.schneider-electric.com/sites/corporate/en/customers/contractors/energy-efficiency-solution-for-buildings/hvac_control_regulate_kitchen_exhaust.page

Spirax Sarco. *Heat Pipe Heat Exchanger: An energy recovery solution*. Cheltenham, UK, 2014. Retrieved 2014, from http://www.spiraxsarco.com/pdfs/SB/p211_02.pdf

TAS Energy. *Pollution? Think Again*. Retrieved 2014, from <http://www.tas.com/renewable-energy/waste-heat/overview.html>

Trane engineers newsletter (volume 36–1). *Water-side heat recovery - Everything old is new again!*. US, 2007. Retrieved 2014, from http://www.trane.com/content/dam/Trane/Commercial/global/products-systems/education-training/engineers-newsletters/waterside-design/admapn023en_0207.pdf

The Carbon Trust. *Variable speed drives: technology guide*. UK, November 2011,

The Carbon Trust. *Low temperature hot water boilers*. UK, March 2012. Retrieved 2014, from https://www.carbontrust.com/media/7411/ctv051_low_temperature_hot_water_boilers.pdf

The Scottish Government. *Worked examples of U-value calculations using the combined method*. UK, 2009. <http://www.scotland.gov.uk/Resource/Doc/217736/0088293.pdf>

US Energy Department. *Drain Water Heat Recovery*. Retrieved 2014, from <http://energy.gov/energysaver/articles/drain-water-heat-recovery>

US Energy Department. *Glossary of Energy-Related Terms*. Retrieved 2014, from <http://www.energy.gov/eere/energybasics/articles/glossary-energy-related-terms#A>

US Energy Department, Industrial technology program. *Waste Heat Recovery: Technology and Opportunities in U.S. Industry*. Retrieved 2014, from http://www.heatispower.org/wp-content/uploads/2011/11/waste_heat_recovery-1.pdf

US Energy Department. *Use Low-Grade Waste Steam to Power Absorption Chillers*. Retrieved 2014, from https://www1.eere.energy.gov/manufacturing/tech_assistance/pdfs/steam14_chillers.pdf

US Energy Department - Hydraulic Institute, Europump, Industrial Technologies Program *Variable Speed Pumping — A Guide To Successful Applications*. May 2004. Retrieved 2014, from http://www.energy.gov/sites/prod/files/2014/05/f16/variable_speed_pumping.pdf

U.S. Environmental Protection Agency. *Energy Star – Air-Side Economizer*. Retrieved 2015, from https://www.energystar.gov/index.cfm?c=power_mgt.datacenter_efficiency_economizer_airside

U.S. Environmental Protection Agency. *Energy Star - Boilers*. Retrieved 2014, from <http://www.energystar.gov/productfinder/product/certified-boilers/results>

U.S. Environmental Protection Agency. *Energy Star – Electric Storage Heaters*. Retrieved 2014, from <http://www.energystar.gov/certified->

REFERENCES

[products/detail/high_efficiency_electric_storage_water_heaters?fuseaction=find_a_product.showProductGroup&pgw_code=WHH](#)

US Energy Department. *Energy Saver - Heat Pump Water Heaters*. Retrieved 2014, from <http://energy.gov/energysaver/articles/heat-pump-water-heaters>

US Office of Energy and Efficiency. *EnerGuide: Heating and Cooling With a Heat Pump*. Gatineau, Canada, Revised December 2004.

UK Department of Energy and Climate Change. *Standard Assessment Procedure for Energy Rating of Dwellings (SAP)*. London: 2009 (March 2010)

York International Corporation. *Energy Recovery Wheels*. Retrieved 2014, from http://www.johnsoncontrols.com/content/dam/WWW/jci/be/integrated_hvac_systems/hvac_equipment/airside/air-handling/102.20-AG6.pdf

Carrier United Technologies. *Economizers*. Retrieved 2015, from http://www.commercial.carrier.com/commercial/hvac/general/0,3055,CLI1_DIV12_ETI12218_MID6123.00.html

REFERENCES

Water

General:

BRE Global Ltd. *BREEAM International New Construction (NC)*. 2013

Sustainable Baby Steps. *Water Conservation: 110+ Ways To Save Water*. Retrieved 2014, from <http://www.sustainablebabysteps.com/water-conservation.html>

U.S. Environmental Protection Agency. *Water Sense website*. <http://www.epa.gov/WaterSense/index.html>

Urinals:

Alliance for Water Efficiency. *Urinal Fixtures Introduction*. Retrieved 2014, from http://www.allianceforwaterefficiency.org/Urinal_Fixtures_Introduction.aspx

U.S. Environmental Protection Agency. *Water Sense. Urinals*. Retrieved 2014, from <http://www.epa.gov/WaterSense/products/urinals.html>

Auto Shut off taps:

UK Department for Environment Food & Rural Affairs. *ECA Water. Efficient taps, Automatic shut off taps*. Retrieved 2014, from <http://wtl.defra.gov.uk/technology.asp?sub-technology=000300030001&technology=00030003&tech=000300030001>

Dishwashers

Which?. *Water saving products: Water efficient dishwashers*. Retrieved 2014, from <http://www.which.co.uk/energy/creating-an-energy-saving-home/reviews-ns/water-saving-products/water-efficient-dishwashers/>

Pre-rinse valves:

U.S. Environmental Protection Agency. *Water Sense. Pre-rinse spray valves*. Retrieved 2014, from http://www.epa.gov/WaterSense/docs/prsv_fact_sheet_090913_final_508.pdf

Water efficient landscaping

Arizona Municipal Water Users Association. *Building Water Efficiency. Landscape*. Retrieved 2014, from <http://www.building-water-efficiency.org/landscape.php>

U.S. Environmental Protection Agency. *Water Sense. Water-Smart Landscapes*. Retrieved 2014, from http://www.epa.gov/WaterSense/docs/water-efficient_landscaping_508.pdf

Condensate water

Alliance for Water Efficiency. *Condensate Water Introduction*. Retrieved 2014, from http://www.allianceforwaterefficiency.org/condensate_water_introduction.aspx

American Society of Heating, Refrigerating and Air-Conditioning Engineers. *ASHRAE Journal: AHU Condensate Collection Economics: A Study of 47 U.S. Cities*. Retrieved 2014, from <https://www.ashrae.org/resources--publications/periodicals/ashrae-journal/features/ahu-condensate-collection-economics--a-study-of-47-u-s--cities>

REFERENCES

Business Sector Media, LLC. Environmental Leader magazine. *Air Conditioning Condensate Recovery*. January 15, 2013. Retrieved 2014, from <http://www.environmentalleader.com/2013/01/15/air-conditioning-condensate-recovery/>

TLV. *Returning Condensate and When to Use Condensate Pumps*. Retrieved 2014, from <http://www.tlv.com/global/TI/steam-theory/types-of-condensate-recovery.html>

Materials

Advanced WPC technologies. <http://wpc-composite-decking.blogspot.com/p/what-is-wood-plastic-composite-wpc.html>

Aldo A. Ballerini, X. Bustos, M. Núñez, A. *Proceedings of the 51st International Convention of Society of Wood Science and Technology: Innovation in window and door profile designs using a wood-plastic composite*. Concepción, Chile: November 2008. <http://www.swst.org/meetings/AM08/proceedings/WS-05.pdf>

Ballard Bell, V. and Rand, P. *Materials for Architectural Design*. London: King Publishing Ltd, 2006.

Krishna Bhavani Siram, K. *Cellular Light-Weight Concrete Blocks as a Replacement of Burnt Clay Bricks*. New Delhi, India: International Journal of Engineering and Advanced Technology (IJEAT), December 2012.

Primary Information Services. *FaL-G Bricks*. Chennai, India. <http://www.primaryinfo.com/projects/fal-g-bricks.htm>

Reynolds, T. Selmes, B. *Wood Plastic Composites*. London: BRE, Feb 2003

United Nations Centre for Human Settlements and Auroville Building Centre. *Ferrocement Channels*. Nairobi, Kenya and Tamil Nadu, India. <http://ww2.unhabitat.org/programmes/housingpolicy/documents/Ferrocement.pdf>

World Bank Group. *India - FaL-G (Fly Ash-Lime-Gypsum) Bricks Project*. Washington, DC: 2006. <http://documents.worldbank.org/curated/en/2006/05/6843612/india-fal-g-fly-ash-lime-gypsum-bricks-project>

APPENDIX 1. EDGE METHODOLOGY

This section outlines the basis for the underlying assumptions, equations and data sets used in EDGE. It explains how a base case is established, how demand is calculated and how local climate conditions influence results.

At the heart of EDGE is a performance calculation engine that harnesses a set of mathematical equations based on the principles of climatology, heat transfer and building physics. Upon receiving design inputs, the calculator charts a building's potential performance in the areas of energy, water and materials. As markets mature, the underlying data in the calculator will be further sharpened, ensuring EDGE becomes more granular and up to date.

A Quasi-Steady State Model

Energy consumption is predicted using a quasi-steady state calculation methodology based on the European CEN standards and ISO 52016. This quasi-steady-state model considers thermal mass within the calculation, using the method detailed in ISO 13790:2008(E), Section 12.3.1.1, in which the heat capacity of the building ($J/°K$) is calculated by summing the heat capacities of all the building elements facing directly into the interior of the building. However, this calculation is not a detailed thermal mass calculation (as might be possible using hourly simulation software).

Rather than suggesting a perfect or prescribed scenario, EDGE provides users with a set of best-practice options to explore to identify an optimum design solution. In this way, the user determines which bundle of technical measures is the best choice for their building to reach required efficiency levels.

The Case for Using a Steady State Model

Dynamic simulation, although credible in terms of results, is difficult to use by the average building professional and lacks transparency in terms of auditing the calculation process¹⁸. The simplified steady state model, on the other hand, proved easier to use and while the generated results lacked a very high degree of accuracy, in most cases the results were repeatable and transparent. Absolute precision is not the most important consideration in a mass market application, especially if it compromises the other attributes such as scalability. The important outcomes are the actions that result. For new buildings, these are the design decisions that governments, investors, developers and building owners are encouraged to consider.

A similar approach has been taken by energy efficiency building codes (e.g. COMcheck in the U.S., Simplified Building Energy Model [SBEM] and SAP in the UK) and Energy Performance Certificates (EPCs in the EU) to find a quick and cost-effective way to benchmark buildings and to quantify carbon emission reductions.

Table 41: Types of Models for Energy Performance

Model Types	Calculations	Advantages	Disadvantages
Empirical model	Rules of thumb, incorporates tables of benchmarks, uses historical data from a large sample of existing buildings and generates an energy consumption baseline	<ul style="list-style-type: none"> Useful reference at the concept stage Mainly used for benchmarking existing buildings and stock data⁷⁸ 	<ul style="list-style-type: none"> Low levels of accuracy Cannot be used to evaluate new designs or efficiency improvements Requires actual building performance data for a large set of existing buildings which is typically not available in most markets
Steady-state model	Steady-state heat loss method; simple methods generally average variables over a diurnal or annual basis; mainly uses accumulated temperature differences or 'degree days' or simplified monthly heat balance calculations	<ul style="list-style-type: none"> Requires less time Relatively little input information required Easy to use by a standard building professional Typically used for building regulations (e.g. UK/Netherlands) Adequate for expressing simple energy calculations (heating and cooling demands⁷⁹) 	<ul style="list-style-type: none"> Does not take account of the dynamics of building response Not suitable for detailed analysis of complex building forms
Dynamic simulation model	Dynamic thermal based on hour-by-hour (or higher resolution) outputs, detailed comfort analysis	<ul style="list-style-type: none"> Higher level of precision Useful for detail design and modeling internal temperature conditions Takes thermal mass into account 	<ul style="list-style-type: none"> Low levels of transparency (i.e. the ability to analyze the calculation process and verify inputs) Poor data quality may introduce greater uncertainty than is associated with the modeling itself⁸⁰ Not scalable for mass use (such as building regulations, energy performance certificates) Data intensive and time consuming⁸¹ Requires the technical expertise of skilled building simulation analysts

⁷⁸ Steadman, Bruhns et al. 2000, "An Introduction to the National Non-Domestic Building Stock Database." Environment and planning B: Planning and design 27: 3-10

⁷⁹ Mervin D.D., 2008, Investigation of Dynamic and Steady State Calculation Methodologies for Determination of Building Energy Performance in the Context of the EPBD, Dublin Institute of Technology, Ireland

⁸⁰ Poel, B. et al 2006, Tool for the Assessment of the Energy Performance of Non-Residential Buildings in the European Countries, Improving Energy Efficiency in Commercial Buildings (IEECB'06) Frankfurt, 26-27 April 2006

⁸¹ Roger Hitch, 2007, HVAC System Efficiencies for EPBD Calculations, BRE Environmental, Watford, UK <http://www.rehva.eu/projects/clima2007/SPs/C04A1002.pdf>

APPENDIX

Determination of Baseline

EDGE defines the Baseline as the standard construction practice currently prevalent in a region (e.g. city, district, state) over the previous three years for the specific building type being evaluated.

In a region which has mandatory building energy, water or materials codes, and where these codes are implemented in a majority of the new buildings being built in last three years, the relevant code serves as the Baseline. If the code is sufficiently implemented in a few cities or states, and not the rest of the country, their baselines can be different.

In a region where no such codes exist, or where they do exist but are not sufficiently enforced, EDGE uses the standard practices followed by the local construction industry as the Baseline. For example, if most low-income homes in a region have walls constructed using concrete blocks, that serves as the EDGE low-income homes baseline. Or, if most hospitals use double-pane windows, that serves as the EDGE baseline for hospitals in that region. These assumptions may be different for different income category homes, and across different buildings types, such as offices, hotels, and shopping malls.

Each location is assigned one of the following four (4) baselines:

1. Country-customized baseline: Countries with distinct building materials or a strong national building energy or water code, such as China or South Africa, have a custom EDGE baseline.
2. City-Customized baseline: Cities in countries with uneven implementation of building energy code, with some cities more stringent than others; or where cities have distinct building patterns because of climate variations have a baseline customized at the city level.
3. Global EDGE baseline: A global set of baseline parameters for emerging economies is used as the baseline for countries that follow typical global practices.
4. ASHRAE 90.1-2016: Advanced economies that typically follow a higher standard of construction are assigned the ASHRAE 90.1-2016 baseline. Distinctions in aspects such as insulation are based on climate zones as per the ASHRAE standards.

Typical efficiencies for heating, ventilation and air conditioning systems for all baselines are based on the ASHRAE 90.1-2016 standard without amendments.

Baseline Update

To keep the EDGE standards relevant, Baseline reviews are undertaken every 3-5 years, if needed. Industry stakeholders and experts are invited to comment on the standard construction practices in their respective countries. The EDGE Application is updated every 3 weeks, and the EDGE database is updated on an ongoing basis as new and better information becomes available.

Basis of Calculations

The purpose of EDGE is to produce consistent and reliable evaluations of resource demand for building certification purposes. While EDGE assists the design process, it is first and foremost a model for directional financial comparisons. It should not be used for making decisions that require a finer level of project-specific calculations not covered by EDGE, such as system sizing or precise payback calculations. For such specific calculations, it is prudent to use custom calculations specific to the project.

APPENDIX

EDGE calculations are based on the following:

1. Climatic conditions of the location
2. Building type and occupant use
3. Design and specifications

The above categories are not mutually exclusive. Rather, they interact to generate the projected energy and water consumption of the building as well as the embodied energy of the construction materials. Even though prescriptive data is used in these categories by default, the outputs of EDGE become more nuanced as user inputs are updated and refined, making the model responsive and dynamic.

Note: The purpose of EDGE is to produce consistent and reliable evaluations of resource demand for building certification purposes. While EDGE assists the design process, it is first and foremost a model for directional financial comparisons. It should not be used for making decisions that require a finer level of detail. If the performance of a feature is critical to the project, it is prudent to use an appropriate modelling tool. For example, EDGE should not be used for system sizing, or precise payback calculations for financial decision-making.

A. Climatic Conditions

The following location-specific information exists within EDGE for all cities built into the EDGE software:

- Monthly average wet and dry bulb temperature
- Monthly average outdoor wind velocity
- Monthly average outdoor humidity
- Solar radiation intensity
- Annual average rainfall
- Carbon dioxide intensity of the electricity grid
- Average cost of energy (by fuel type) and water

If a city is not included as an option, then a city that is nearby or similar in weather can be used as the location. In such a case, the monthly average outdoor temperature, latitude and average annual rainfall data should be updated under the Climate Data to match the city where the project is located. Climatic conditions for more cities are continuously being added.

B. Building Type and Occupant Use

EDGE is available for the following building types:

- Homes: for both apartments and houses (assumptions for area and occupancy are based on income categories)
- Hotels: for hotels, resorts, and serviced apartments (assumptions for area, occupancy and the type of support services are based on the star rating of the property)
- Offices: assumptions are based on occupancy density and hours of use
- Hospitals: assumptions are based on the type of hospital (e.g., nursing home, private or public hospital, clinic or diagnostic center)
- Retail: assumptions are based on the type of retail building (e.g., department store, mall, supermarket)

APPENDIX

- Industrial: Light Industrial or Warehouse
- Education: assumptions are based on the type of educational facility (e.g., pre-school, university or sports facility), as well as occupancy density and hours of use.
- Mixed Use

Equipment in a building is determined by the building's purpose. Specific equipment and its schedule of operation in a hotel, for example, will differ from that of an office or hospital, or between hotels if a hotel is 3-star or 5-star.

Because it is uncommon for a user to have a complete set of building parameters at the design stage, EDGE provides default data to initiate the base case in each type of building. For instance, in a hotel, if the user only knows the total building area, the number of guest rooms and the number of stories, EDGE suggests dimensions for the key functional spaces to help with early design stage decision-making. EDGE provides the user the opportunity to fine-tune the assumptions to achieve a more precise prediction of results.

C. Design and Specifications

Base Case vs. Improved Case:

The base case for a typical building is the starting point for resource reductions within EDGE. Assumptions are used to create the base case for buildings at the design stage. Every project's unique base case is developed using empirical data from actual buildings reflecting current practices around the world. The base case includes the "non-regulated" energy usage of the building (such as from catering and appliances) to provide a complete picture of projected energy usage and savings.

The improved case shows savings when the user selects technical measures for inclusion in the design. The difference in consumption between the base case and the improved case defines whether a building meets the EDGE standard. In addition to consumption savings, EDGE also reports GHG and operational cost reductions. Incremental costs for the selected technical measures and the payback period are also projected.

Baseline Assumptions:

While EDGE has been developed for global use, the software has been customized at the local level through the support of country-based institutions that provided market studies and data collection. Through their support, further granularity has been brought to the base case parameters and assumptions, and the choice and qualifications of the resource efficiency measures has been fine-tuned. These assumptions are updated as the market evolves. This method allows EDGE to become increasingly relevant and applicable to local standards and practices.

To determine the base case parameters for efficiency in energy, water and materials, EDGE relies on information gleaned from typical building practices as well as national/local building performance codes, where they are in existence and being enforced. If there is an energy efficiency code (EEC) in practice in a certain country, such as in South Africa, then it is used to generate the base case calculation. Typical systems

APPENDIX

efficiencies for heating, ventilation and air conditioning systems are based on ASHRAE-90.1 2016⁸². Baseline assumptions have been adjusted where necessary to improve the match to local conditions.

Following are a few issues that were considered while establishing the properties of the base case:

Thermal properties of the building envelope: Most building owners/developers do not readily adopt certain practices that are un-regulated and add to the capital cost. The EDGE base case of a building's thermal properties therefore reflects the typical practice in the specific country. Some of the global assumptions for residential buildings, which are updated based on local market surveys, are as follows⁸³:

- No solar shading devices
- Un-insulated concrete roof
- Un-insulated walls with plastered brick masonry
- Single-glazed metal windows

Other residential characteristics include:

- Room air conditioning (where A/C is used)
- Conventional boilers for space heating and hot water (where fuel boilers are chosen)
- A mix of incandescent bulbs, CFL, LED and T12 florescent tubes for lighting with no lighting controls
- Water fittings with high flow rates
- No reuse or recycling of water

Window-to-Wall Ratio (WWR): A study of façades of building typologies across various regions indicates that non-residential buildings have an average WWR ranging from 50-60%, therefore a WWR of 55% was set as the baseline for non-residential buildings. A WWR of 30% was set as the baseline for residential buildings, based on IFC's experience with housing clients.

Building Orientation: For residential projects, the building orientation is assumed as the average of eight directions (i.e., omnidirectional) for the following reasons:

1. Requiring the user to calculate the orientation and geometry of each flat/apartment or house in a development would add cost and time to the certification process.
2. It is impractical for large projects and apartment blocks to optimize the orientation of all units in the ideal direction.

EDGE accounts for orientation in non-residential buildings such as offices, retail, hospitals and education where designers have a greater chance of controlling the building's orientation and reducing excessive solar heat gain. The only exception is hotels which are typically oriented towards favorable views or to take advantage of street visibility, and therefore their orientation is also averaged over eight directions.

Note: The measures within EDGE are integrated to ensure efficiencies are not double-counted. For example, there are two options for window improvements (either low-E coated glass or higher thermal performance

⁸² <https://www.ashrae.org/resources--publications/bookstore/standard-90-1>

⁸³ The final assumptions may vary in countries where EDGE has been calibrated and contextualized

APPENDIX

glass). If the user selects both, EDGE only recognizes the more advanced option. This is also true for measures that have overlapping impact such as lower WWR value and improvements to window U-values that collectively affect the overall savings. EDGE takes these interactions into account.

Calculating End Use Demand

EDGE utilizes thermal calculations to determine the building's overall energy demand, including requirements for heating, ventilation and air-conditioning, as well as domestic hot water, lighting demands and plug loads. EDGE also estimates water use and the embodied energy in materials used in constructing the building, to create a comprehensive analysis of projected resource usage.

A. Overall Energy Demand in Buildings

Since a building generally uses more than one fuel from different carriers (e.g. electricity, natural gas, diesel, or district cooling/heating), EDGE converts primary energy into "delivered" energy values to provide a common metric. The combined outputs for energy use are relayed as delivered energy (rather than primary energy or carbon dioxide emissions) to best communicate efficiency gains to users, who relate more easily to results when expressed as lower utility bills. As EDGE evolves it is possible that primary energy projections may also be provided.

Renewable energy generated on site (e.g. electricity from solar photovoltaics or hot water from solar collectors) is deducted from the building's improved case and is expressed as "energy savings."

B. Heating, Ventilation and Air Conditioning Demand

EDGE uses a **monthly quasi-steady-state calculation method** based on the European CEN⁸⁴ and ISO 13790⁸⁵ standards to assess annual energy use for the space heating and cooling of a residential or non-residential building. The method was chosen for its ease of data collection, reproducibility (for comparability and in case of legal requirements) and cost effectiveness (of inputs gathering). For additional clarification, refer to Appendix 1: *Types of models for energy performance*.

A similar approach has been taken for energy efficiency building codes ((e.g. COMcheck⁸⁶ in the U.S., Simplified Building Energy Model (SBEM)⁸⁷ and SAP⁸⁸ in the UK, and Energy Performance Certificates (EPCs in the EU)) to find a quick and cost-effective way to benchmark buildings and to quantify energy savings.

The assessment of a building's energy performance is comprised of the following main categories:

⁸⁴ European Committee for Standardisation (CEN)

⁸⁵ ISO 13790:2008 gives calculation methods for the assessment of annual energy use for space heating and cooling of a residential or a non-residential building

⁸⁶ <http://www.energycodes.gov/comcheck/>

⁸⁷ www.ncm.bre.co.uk

⁸⁸ <http://projects.bre.co.uk/sap2005/>

APPENDIX

- Space heating
- Space cooling
- Fans
- Pumps
- Lighting
- Other (appliances)
- Hot water
- Cooking

C. Virtual Energy for Comfort

When there are no plans to install a heating or an air-conditioning system in a building, EDGE calculates the energy that is required to ensure thermal comfort, with the assumption that eventually HVAC systems, fans or heaters will be installed. EDGE demonstrates this future required energy for comfort as “virtual” energy, articulating it separately for ease of understanding. While the utility costs in the results do not reflect virtual energy, EDGE determines whether a building is projected to achieve 20% energy efficiency by subtracting the improved case with virtual energy from the base case with virtual energy.

D. Energy Demand for Hot Water Requirements

EDGE algorithms are based on EN 15316-3⁸⁹, which has both the specifications of hot water requirements for different types of buildings and the energy calculations needed to provide them. The basic calculation for annual hot water demand uses the following parameters:

- Cold water supply temperature (derived from the mean annual temperature of the project’s location)
- Hot water delivery temperature (the temperature of the hot water at the delivery point, which is set at 40°C)
- Daily hot water demand (based on water usage patterns and the number of days used)
- Energy need for hot water (hot water consumption per day x the water usage factor x the number of days/year x the boiler efficiency)
- Fuel energy needed (the fuel’s hot water heating energy x (the fuel’s consumption in L/the fuel’s calorific value)/the boiler’s efficiency)

E. Lighting Energy Demand

EDGE uses the “quick method” under EN 15193’s energy requirements for lighting to estimate the annual energy use for lighting a building. The calculations are based on installed lighting power and annualized usage according to building type, occupancy and lighting controls.

F. Water Demand in Buildings

Estimating water demand is relatively simple in comparison to energy. EDGE estimates fresh water use to determine overall water consumption. Recycled water or rainwater harvested on site is deducted from the

⁸⁹ <http://iristor.vub.ac.be/patio/arch/pub/fdescamp/bruface/products/dhws/15316-3-1-Need.pdf>

APPENDIX

building's improved case and is rendered as water "savings".

Although there are no international standards to calculate water use in buildings, the EDGE methodology is like many other calculators used around the world (such as the UK government's "The Water Efficiency Calculator for New Dwellings⁹⁰").

EDGE estimates annual water use through the following:

- Number of water fixtures (showers, taps, toilets, etc.)
- Water usage loads (occupancy, usage rates and the rate of water flow through the fixtures)

EDGE does not calculate water use for such external activities as car washing.

G. Estimating Rainwater Harvesting or Recycled Water Onsite

Rainwater Harvesting

EDGE calculates the maximum quantity of water that can be collected by a rainwater harvesting system using rainfall data from the project location and the size of the roof area from the design inputs. The following basic calculation is used: Total annual rain water: Area of Catchment (i.e. roof area-m²) x Amount of Potential or Volume of Rainfall (mm) x Filter Coefficient (assuming 20% losses) x Run-off Coefficient

Recycled Gray Water

EDGE calculates the potential supply and reduces the demand for flushing toilets by that amount. EDGE assumes that all wastewater from kitchens and bathrooms is collected and stored to meet the demand for flushing toilets. If the quantity of wastewater is insufficient, then EDGE simply deducts the wastewater available from the total demand.

Recycled Black Water (Effluent Treatment)

EDGE calculates the potential supply and reduces the demand for flushing toilets by that amount. EDGE assumes that most of the wastewater (80%) from flushing toilets is collected, treated and stored to meet the demand for future flushing or other outdoor uses.

H. Embodied Energy in Building Materials

EDGE incorporates available embodied energy data of global construction materials.

The main source is a custom study conducted by the UK-based firm thinkstep for EDGE called the "[EDGE Materials Embodied Energy Methodology & Results](#)" report that is also available on the EDGE website. The environmental impacts of materials vary according to where and how they are manufactured and used. Due to the global scope of EDGE, incorporating accurate impact data for materials in all locations is not yet possible. Instead, a targeted and phased approach is adopted that initially provides a single global Emerging Economies Construction Dataset (the "EDGE Dataset") for embodied energy of construction materials based on a life cycle

⁹⁰ <https://www.gov.uk/government/publications/the-water-efficiency-calculator-for-new-dwellings>

APPENDIX

assessment (LCA) model. Future phases will provide datasets for specific countries for use in national implementations of EDGE, which may consider other impact categories such as climate change.

Another source of reference for the data is the Inventory of Carbon and Energy (ICE) developed by the University of Bath. This data is available in the public domain.

Embodied Energy is calculated using the following equation:

Embodied Energy per Unit Area (MJ/m²) = Thickness (m) x Density (kg/m³) x Embodied Energy (MJ/kg)

Validating the Logic

To ensure that EDGE energy results are consistent and reliable, the calculation methodology was validated by using dynamic simulation software ([eQuest](#)) for buildings in nine locations and the results for each of the nine locations were compared to EDGE results.

Additionally, initial reviews of EDGE for Homes have been conducted by third-party consultants in the Philippines and Mexico to validate the software for local markets:

- In the Philippines, third-party consultants ([WSP Group](#)) conducted a study in 2013 to compare results between EDGE and [IES](#) dynamic simulation software. The test concluded a variation of 5%.
- In Mexico, Lean House Consulting was commissioned in 2014 to compare results between EDGE and two dynamic simulation software applications, [DOE](#) and [Design Builder](#) for four locations: Cancun, Guadalajara, Hermosillo and Mexicali. The test concluded a variation of 7-8%.
- EDGE was validated for the housing sector in South Africa in 2015 by a consultant and reviewed by a panel of experts.
- EDGE was reviewed in India in 2016 against other software applications and results were found to be within 10%.
- EDGE was reviewed in China in 2016. The China baseline was updated based on Chinese regulations.

A less than 10% variance was deemed acceptable.

Envisioning the Future

EDGE is intended to meet the demand for a quick, easy and affordable online application that can be used to plan and assess the design of resource efficiency to scale up green building growth. The complexity of the underlying methodology is kept away from the application's interface so that industry professionals can easily determine resource efficiency and associated cost savings without the necessity of hiring energy specialists or purchasing additional modeling software.

EDGE continuously evolves as new data becomes available, standards become more demanding, and additional markets begin implementation of EDGE. To ensure EDGE continues to improve, insights from building professionals around the world are encouraged. For ideas on how to enhance the product, clarify the methodology and reach mass markets, email the EDGE team at edge@ifc.org.

APPENDIX 2. GROUPING LOGIC FOR RESIDENTIAL UNITS (THE 10% RULE)

The 10% rule governs which residential units can be grouped together and modeled as a single unit type in EDGE.

RULE: For any representative residential unit in EDGE, the actual area of the represented unit must be within 10% of the modeled area ($\pm 10\%$). If the area of a unit differs from the average by more than 10%, it must be modeled separately.

Example 1: Half the units in a project are Unit Type A (85 m^2) and the other half are Unit Type B (95 m^2). The average area of these two is $90\text{ m}^2/\text{unit}$. The areas of Unit Types A and B are within 10% of 90 m^2 , so Unit Types A and B can be modeled together in EDGE as, say, Unit Type 1 with an area of $90\text{ m}^2/\text{unit}$.

Any number of similar units within a 10% area range of the average can be modeled together. The admissible area range for the units represented by Unit Type 1 in Example 1 is $90\text{ m}^2 \pm 10\% = 81\text{ m}^2$ to 99 m^2 . This is illustrated in Figure 32 below. The Area of any admissible units for Type 1 must be $81\text{ m}^2 < \text{Area} < 99\text{ m}^2$.

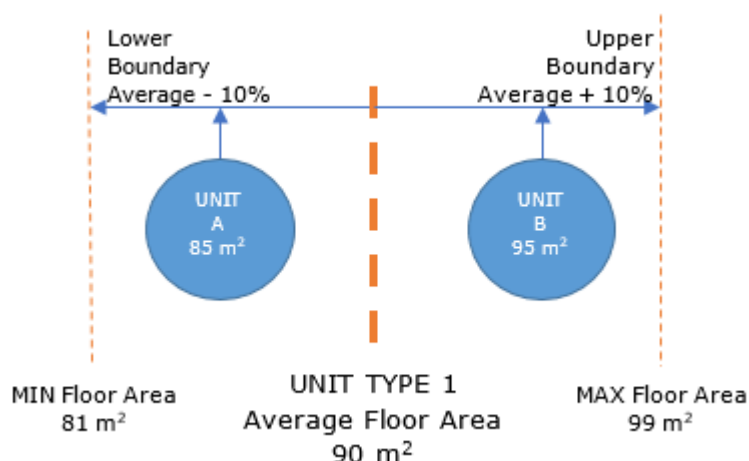

Figure 32. The admissible range of areas that can be represented by a single unit type in an EDGE residential model

Note 1. Units with areas outside the admissible range must be modeled separately.

Example 2: In Example 1 above, a unit with 80 m^2 area, or a unit with 100 m^2 area cannot be grouped in with Unit Type 1.

- a. For individual unit area values into the decimals, a user should round up or down to the nearest single digit after the decimal.

Example 3: An area of 99.03 m^2 would round to 99.0 m^2 , and therefore qualify in Example 1 above. But a unit with an area of 99.05 m^2 would round to 99.1 m^2 and would not qualify to be grouped with Unit Type 1 in Example 1.

- b. The average values of unit areas must be kept to the second decimal place, to avoid unintended variation from the average.

Example 4: If half the units are 74.3 m^2 and the other half are 88.6 m^2 , the average unit area

APPENDIX

will be 81.45 m². The permissible range of actual areas that can be represented by this average unit type is 90% \times 81.45 to 110% \times 81.45 = 73.3 m² to 89.6 m²

Note 2. For units with unequal number of units, take the count-weighted average (not the simple average) of the area. This will result in correct total calculations of the GIA for the entire project.

Example 4. If there are 20 units of Unit Type A (80 m²) and 30 units of Unit Type B (90 m²), the count-weighted average is $(20 \times 80 + 30 \times 90) / (20 + 30) = 86$ m²/unit (unlike Example 1 where it is 85 m²).

Note 3. The rule only applies to similar units, that is, to units with the same number of bedrooms and high-level characteristics such as single story or duplex. Units of different types, such as 1-bedroom and 2-bedroom units, must be modeled separately.

- a. EXCEPTION: If a unit type consists of 5 units or less and the total area of these units represents less than 10% of the project GIA, that unit type does not need to be modeled separately. It can instead be grouped with the most similar unit type.

Example 5: A building has 300 units of which 297 units are 2-bedroom units of assorted sizes, and only 3 units are one-bedroom units. In this case, the one-bedroom units may be grouped with the most similar 2-bedroom units.

Steps to Calculate and Test the Average Unit Area

Step 1 Calculate the weighted average.

Example 6. A project has 40 units of 3 different types as shown in the table below.

	Unit Count (n)	Unit Area (A) (m ²)
Unit A	10	86
Unit B	20	92
Unit C	10	100

The weighted average area per unit is:

$$\frac{n1A1 + n2A2 + n3A3}{n1 + n2 + n3}$$

or

$$(10 \times 86 + 20 \times 92 + 10 \times 100) / (10 + 20 + 10) = 92.5 \text{ m}^2/\text{unit}$$

Step 2 Calculate the acceptable range to determine whether the units can be grouped together.

In Example 6 above, the acceptable range can be determined as follows:

Minus 10% from the average value of 92.5 m² equals 90% \times 92.5 = 83.3 m²

Plus 10% to the average value of 92.5 m² equals 110% \times 92.5 = 101.8 m²

$$83.3 \leq 86, 92, \text{ and } 100 \leq 101.8 \text{ is TRUE}$$

Conclusion: Type A, Type B and Type C units in Example 6 are larger than 83.3 m² and smaller than 101.8 m². Therefore, they are within the acceptable range and can be grouped as one Unit type in EDGE.

APPENDIX

Example 7. Type A units are 10 units of 80 m², and Type B are 10 units of 100 m²

Average = $(10 \times 80 + 10 \times 100) / (10 + 10) = 90 \text{ m}^2$

Acceptable range of unit areas:

Minus 10% from 90 m² equals $90\% \times 90 = 81 \text{ m}^2$

Plus 10% of 90 m² equals $110\% \times 90 = 99 \text{ m}^2$

$81 \leq 80$ and $100 \leq 99$ is FALSE

Conclusion: The areas of Type A and Type B units are outside the acceptable range and therefore the units cannot be grouped together in EDGE.

Note: The related input for the 'External Wall Length /Unit' has a significant impact on results and must be represented correctly. It must be calculated by taking a weighted average of the exterior wall lengths for the units being modeled together.

APPENDIX 3. COUNTRY SPECIFIC CONSIDERATIONS

South Africa

SANS Building Regulations

SANS Building Regulations standards are referenced in the EDGE software to ensure that if a project meets EDGE requirements it also meets SANS requirements. If there are issues with SANS compliance text alerts will appear below the energy section and will also appear in the downloadable pdf (if the user chooses to generate it). Note that EDGE should not be used as a compliance tool for SANS as there are additional requirements mandated by SANS that are not included in EDGE.

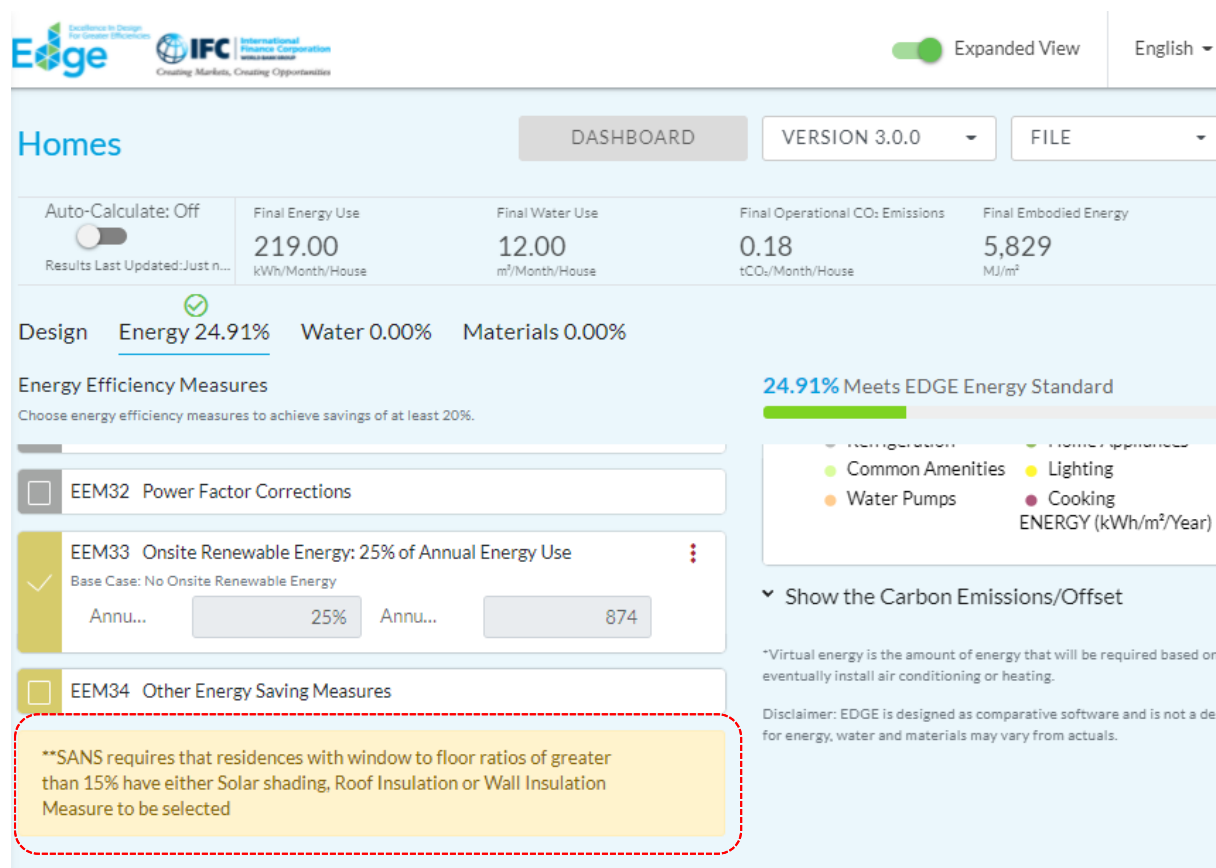

Figure 33. SANS alerts for South Africa appear below the Energy measures when projects meet the EDGE standard of 20% energy savings but do not meet SANS requirements. This alert is specific to South Africa.

EEM01 – Reduced Window-to-Wall Ratio

Project teams in South Africa generally use the Window-to-Floor Ratio (WFR) rather than the Window-to-Wall Ratio (WWR) used in EDGE. EDGE has therefore added the WFR metric in the Window-to-Wall Ratio measure for South Africa. To change the WFR, users must modify the WWR. WFR cannot be modified directly in the EDGE user interface (UI).

Changing the WWR changes the area of windows in the EDGE software. This automatically modifies the WFR, where WFR is calculated as follows:

$$WFR = \frac{\text{Total Window Area}}{\text{Total Floor Area}}$$

The total floor area remains constant (based on the inputs in the Design page), the total window area may be modified by changing the WWR.

WFR increases as WWR increases, but WWR and WFR are not directly proportional. A conversion factor is not possible since the dependent variables are not the same for WWR and WFR.

EEM06 and EEM08 – Insulation of Roof and External Walls

The South Africa (SANS) baseline U-Value is already strict, which translates to good insulation levels. So, the addition of insulation better than the SANS requirements may not provide a financially viable energy savings option.

EEM18 – Heat Pump for Hot Water Generation

When Heat Pumps for hot water are selected as an Energy Efficient measure for South Africa, 50% of the system allocation applies towards meeting existing SANS energy requirements. Therefore, only the remainder of the system allocation counts towards EDGE energy efficiency achievements.

China

Green Building Evaluation Label (GBL), also known as the “3-Star” System

EDGE Version 3 includes the ability to demonstrate compliance with certain categories of China’s Green Building Evaluation Label (GBL), also known as the “3-Star” System. China GBL is a green building certification program administered by the Ministry of Housing and Urban-Rural Development of the People’s Republic of China (MOHURD). GBL evaluates projects based on eight categories: land, energy, water, resource/material efficiency, indoor environmental quality, construction management, operational management, and a bonus category for innovation.

The EDGE software can be used to demonstrate compliance in four of the eight GBL categories for the GBL points listed in the table in this section. Note that not all GBL categories are included in EDGE. The EDGE software includes nearly 30 cities in China. The EDGE baseline for projects located in China follows the GBL system instead of the ASHRAE baseline. EDGE also provides GBL-specific calculators for China projects within the EDGE user interface.

Users can create a project in EDGE with a location in China, select the measures included in their project, and use the GBL calculators to generate inputs for the EDGE App. Users can then generate a GBL report in the EDGE App by going to File > Download GBL Report.

Some features unique to the EDGE user interface for China are:

1. The “Building Data” section on the Design tab includes a field for the “Building Shape Coefficient.”

$$\text{Building Shape Coefficient}(C) = \frac{\text{Building Exterior Area}}{\text{Built Volume}}$$

The smaller the Building Shape Coefficient, the less the heat loss via the building envelope and the less the energy consumption.

2. Window-Wall Ratio (WWR) baseline assumptions
 - Residential buildings: When the WWR of any orientation of the building exceeds the code limits (has higher WWR), the base case WWR of that orientation shall be the same as the maximum value stipulated by code. When the design WWR is within the code limits, the base case WWR shall be same as the design WWR for the orientation.
 - Non-residential buildings: The base case WWR shall be same as the design WWR for each orientation.
3. The “Building Systems” section on the Design tab includes dropdown menus to select system types for AC and heating.
 - The AC system defaults to a DX Split System
 - The space heating system has four choices
 - i. Fuel Gas Boiler
 - ii. Layered Combustion Boiler
 - iii. Spreader Chain Grate Boiler
 - iv. Fluidized Bed Combustion Boiler
4. There are GBL calculators built into the measures. For example, if “HME16: Energy-saving Light Bulbs” measure is selected in the Homes tool, a GBL- Lighting Power Density calculator becomes available. There are also additional GBL calculators available at the bottom of the Energy tab. These are:
 - GBL – Lighting Control, and

APPENDIX

- GBL – Openable Window/Façade Ratio

GBL Category	Measure	Total Points Available through EDGE
ENERGY		68
5.1.4 & 5.2.10	Lighting Power Density	8
5.2.1	Window to Wall Ratio	6
5.2.2	Openable Window/Façade Ratio	6
5.2.3	Design Thermal Performance Improvements	10
5.2.4	Equipment Efficiency Improvements	6
5.2.6	HVAC System Energy Saving	10
5.2.9	Lighting Control	5
5.2.13	Energy Recovery from Exhaust Air	3
5.2.15	Waste Heat Recovery	4
5.2.16	Renewable Energy	10
INDOOR ENVIRONMENTAL QUALITY		13
8.2.10	Natural Ventilation	13
WATER		43
6.2.6	Water Fixtures	10
6.2.8	Condenser Water System	10
6.2.10	Non-Traditional Water Utilization (Landscaping, Lavatory, Car Washing & Road Washing)	15
6.2.11	Non-Traditional Water Utilization (Condenser Water Use)	8
EXEMPLARY PERFORMANCE AND INNOVATION		5
11.2.1	Design Thermal Performance Improvements	2
11.2.2	Equipment Efficiency Improvements	1
11.2.4	Water Fixtures	1
11.2.11	Carbon Emission Calculation	1

APPENDIX 4. RECORD OF POLICY UPDATES IN THE USER GUIDE

<i>Date</i>	<i>Location</i>	<i>Old Text</i>	<i>Update</i>
			Updates to the user guide will be noted here.

Page intentionally left blank



edgebuildings.com

EDGE

An innovation of IFC, EDGE creates intersections among developers, building owners, banks, governments and homeowners to deepen the understanding that everyone wins financially by building green. EDGE jumpstarts the mainstreaming of green buildings to help tackle climate change.

IFC

IFC is a member of the World Bank Group that focuses on private sector development. Working with partners in more than 100 emerging markets, IFC invests, advises and mobilizes resources from others, creating opportunity for clients in a broad range of industries.